

**TIRES SUPPLY
CATALOG**

AUTEL MAXI TPMS

MX-SENSOR BLE-A001

TESLA-READY, PRE-PROGRAMMED BLUETOOTH TPMS SENSOR

FIT & GO

P/N: **300100**

- OE-Level Functionality
- Tesla-Ready Pre-Programmed Bluetooth TPMS Sensors
- Compatible with Tesla 3, Y, S, and X models with BLE TPMS Sensors

BUILT FOR DURABILITY AND LONG LIFE

- Automotive-grade Bluetooth processor
- 6 years of battery life

PROGRAMMABLE BLUETOOTH LOW ENERGY (BLE) SENSORS

- Programmable for new vehicles using Bluetooth TPMS for smarter, more connected tires
- Program with new Autel MaxiTPMS TS900 tablet and ITS600 tablet

ADJUSTABLE-ANGLE SENSOR

15°-34° for a more secure fit for a broader range of vehicles.



COMPLETE
OE QUALITY SENSORS



SOLUTION
POWERFUL SCAN TOOLS

ITS600

TPMS DIAGNOSTICS & SERVICE

- Print/Email/Text TPMS Health Report
- OLS, BMS, SAS, EPB Service Resets
- **FREE** TPMS Updates for the Life of the Tool
- Wireless Touchscreen Android-based Tablet Tool
- Activates, Reads and Relearns All Known Sensors
- Two MX-Sensor Program Modes;
Batch Program Up to 20 MX-Sensors

- 5.5 Inch Color Display; Android 9.0 OS
- Includes Wireless Bluetooth Vehicle Communication Interface (VCI)
- On-Tool DOT Tire Registration
- Enhanced, At-a-Glance Diagnostics Status Screen
- Rapid VIN Acquisition Via Optical VINscan Function



AUTEL ACADEMY TECHNICAL TRAINING

AUTEL

AUTEL MAXITPMS

MX-sensor 1 SENSOR

THE BEST SELLING
AFTERMARKET  SENSOR
IN NORTH AMERICA

FAST INSTALLATION
PRESS RELEASE
INTERCHANGEABLE
VALVE STEMS



99% VEHICLE COVERAGE

ORIGINAL EQUIPMENT FIT FORM & FUNCTION



PROGRAMMABLE
UNIVERSAL TPMS



MAX SIGNAL
STRENGTH

BLUETOOTH LOW
ENERGY TPMS SENSOR

NEW

- PRE-PROGRAMMED
- TESLA-READY
- PROGRAMMABLE FOR BLE-EQUIPPED VEHICLES



MAXITPMS ITS600

HANDHELD TPMS SERVICE & DIAGNOSTIC TABLET

- Wireless Touchscreen/Android 9.0
- Activates, Reads and Relearns All Known Sensors
- Program AUTEL MX-Sensors to replace 99% of TPMS sensors on the vehicles on the road today
- On-Tool DOT Tire Registration with CIMS Account
- Enhanced, At-a-Glance Diagnostics Status Screen + TPMS Health Report
- Read/Erase All System Codes and Perform OLS, BMS, SAS & EPB
- Compatible with Autel's new Tesla-ready and programmable Bluetooth Low Energy TPMS Sensors

MAXITPMS TS900

3-IN-1 TPMS, ADVANCED DIAGNOSTICS, & SERVICE TABLET



- Includes all features & functions of the ITS600 plus...
- Android 11 OS
 - Perform Bi-directional Active Tests & Special Functions
 - Extensive Service Menu with direct access to over 40 maintenance tasks
 - Generate Detailed Pre- & Post-Scan Reports
 - Wi-Fi sharing and printing



AUTEL ACADEMY TECHNICAL TRAINING

Visit autel.com/us/academy and register today for hands on automotive diagnostic, repair, service, and ADAS instruction.

AUTEL®



THE POWER YOU NEED.
The Quality You Deserve.

VEHICLE REPAIR SOLUTIONS



231HA-2



2145QiMAX



285B-6



DXS Drive Xchange System™
2236QtiMAX



DXS® DRIVE XCHANGE SYSTEM™ ACCESSORIES
Available as Individual
ANVILS or
SOCKETS & SETS

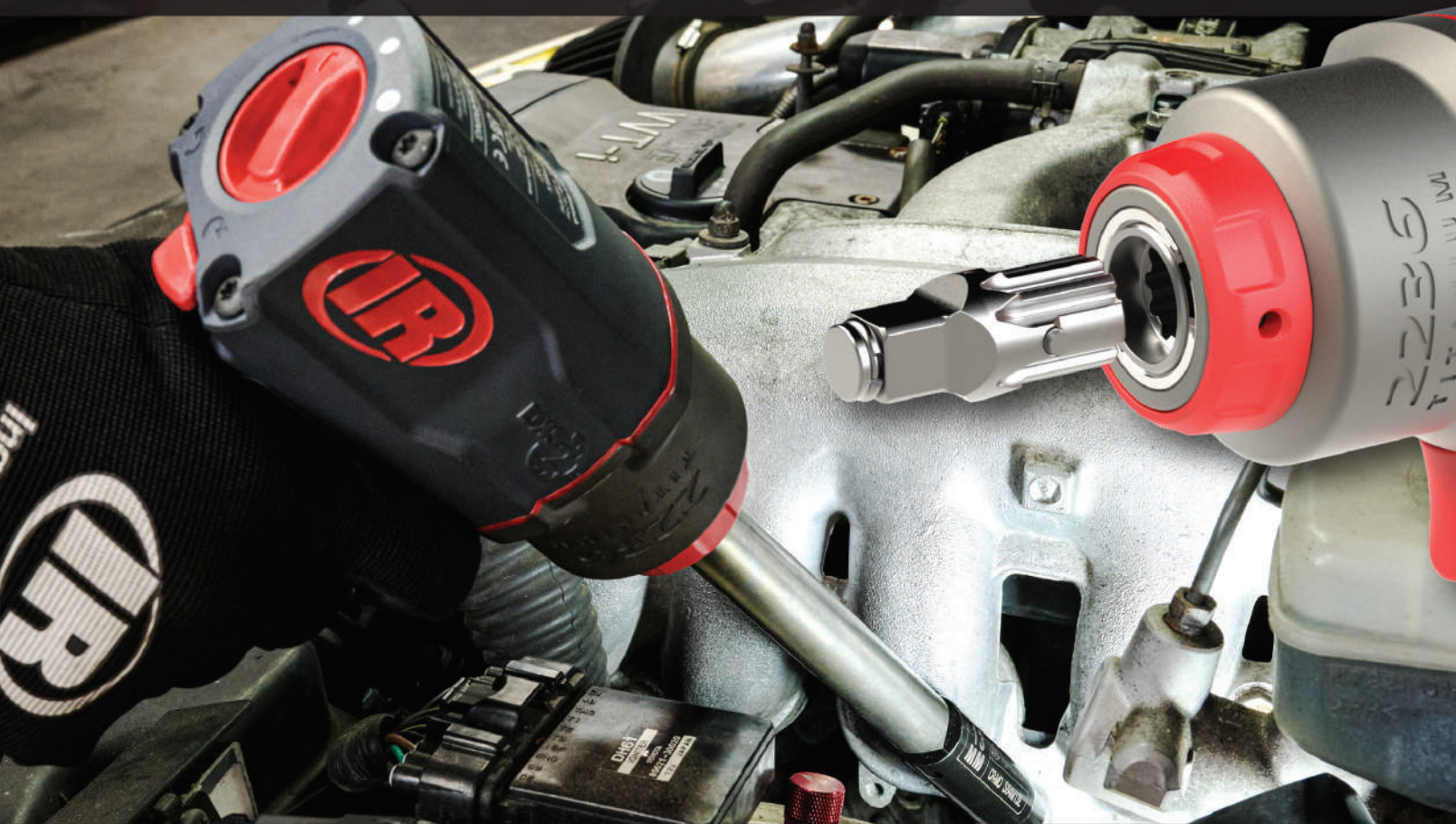



TIRE PROFESSIONALS INSIST ON



AUTOMOTIVE • COMMERCIAL • AG / CONSTRUCTION • OTR / MINING



TABLE OF CONTENTS

● NEW PRODUCT HIGHLIGHTS	8
● AIR SYSTEMS	
Filters, Regulators, Lubricators & Accessories	14
Air Hoses & Accessories	16
● AIR TOOLS	
Air Tools & Accessories	22
Air Tool Lubricants	38
● WHEEL SERVICE PRODUCTS	
Torque Wrenches & Accessories	39
Impact Socket Sets	48
Individual Impact Sockets	52
Miscellaneous Wheel & Rim Parts	54
● LIFTING EQUIPMENT	
Lifting Equipment & Accessories	57
Portable Hydraulics & Jack Plates	71
● TIRE & WHEEL SERVICE	
Miscellaneous Mechanic's Tools	73
Interior Protection Products	76
Wheel & Rim Dismounting Tools & Accessories	80
Bead Breakers & Bead Seating Devices	89
Tire Changers & Accessories	102
Brushes & Lubricants	106
Tire Branders & Regrooving Tools	113
Miscellaneous Tire Service Tools	115
Safety Inflation Cages	118

● VALVE HARDWARE

TPMS Transmitters & Accessories _____ **121**
 Tire Valves _____ **136**
 Valve Hardware Tools & Accessories _____ **139**
 Misc Tire Servicing Tools _____ **145**
 Air Pressure Gauges & Inflator Gauges _____ **149**
 Air Chucks & Accessories _____ **158**

● WHEEL BALANCING SUPPLIES

Lead, Zinc & Steel Wheel Weights _____ **161**
 Adhesive Wheel Weights _____ **165**
 Wheel Balancing Tools & Accessories _____ **168**

● AUTOMOTIVE/FLEET SERVICE EQUIPMENT

Miscellaneous Auto & Fleet Service Products _____ **180**
 Wrenches & Tools _____ **190**
 Mechanic's Gloves _____ **191**

● TIRE REPAIR MATERIALS

Tire Repair Tools & Accessories _____ **193**
 Cements, Sealants & Patches _____ **204**
 Tire Repair Cabinet _____ **210**
 Tire Spreaders _____ **211**

● ALPHABETICAL INDEX _____ 215

● NUMERIC INDEX _____ 218

Ascot Supply Corporation is not responsible for inadvertent typographical errors or omissions. Images included in this publication may appear different to the actual inventoried item.

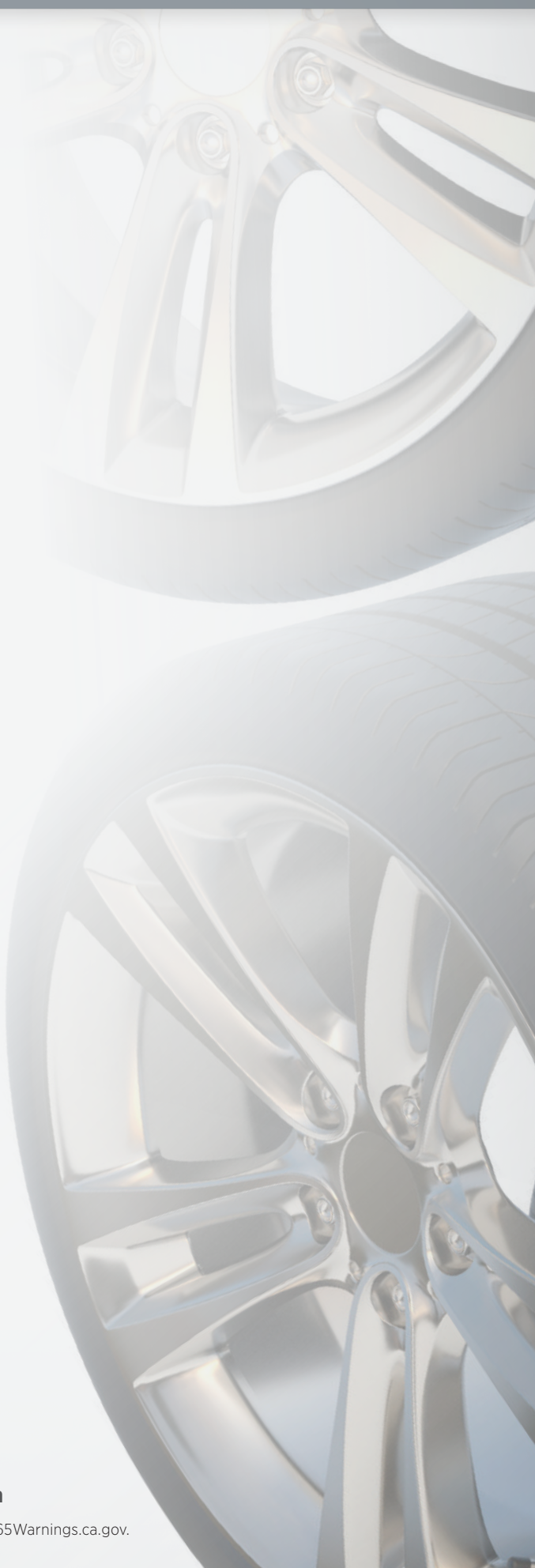

2025 NEW PRODUCT FEATURES



454-06763
PCD Wheel Bolt
Measuring Tool



429-10005
5lb. Bead Breaker
Hammer



429-10010
10 lb. Bead Breaker
Hammer



469-01690
Large Bore 4-Way
Valve Core Tool

319-76403
Professional 4
pc. Pry Bar Set

312-07179
LED
Rechargeable
Pen Light



157-03254
Conical Eraser Pads



454-11410
Aluminum OTR Tire
Tread Depth Gauge

www.ascotsupply.com

⚠️ WARNING: For more information go to www.P65Warnings.ca.gov.



319-00033
6 Pc. Inflatable Air Wedge Bag Kit



319-00012
12-Pc. Tap & Die Set



469-00024
Cable Type Valve Fishing Tool - 24"



396-00357
EVA Foam Kneeling Pad



421-71750
Portable Tire Press



476-11250
Large Bore High Pressure Air Gauge

537-00083
Color Coded Tire Injury Measuring Tool

2025 NEW PRODUCT DIRECTORY



Ascot Supply Corporation is committed to bringing you the newest and most advanced brand name equipment, tools and supplies for the tire industry. Please take a look at our listing below to see all the new items we have to offer in our 2023 Warehouse Catalog.

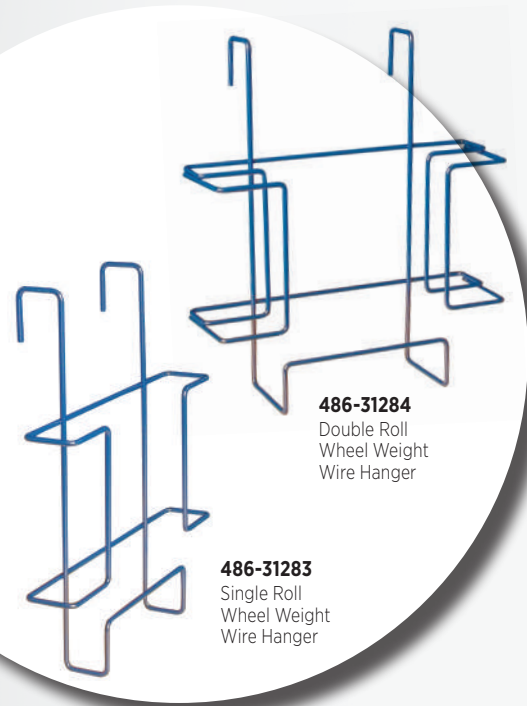

ASCOT NO.	MFG. NO.	PRODUCT	PG.
107-69102	91002ASC	5-Gallon Portable Air Tank	17
131-01750	1750BK	¼" 5-In-1 Universal Safety Exhaust Quick Connect Female Coupler	18
153-22360	IR2236TiMAX	½" DXS Quiet Ultra Duty Air Impact Wrench - Standard Anvil	29
153-22362	IR2236TiMAX-2	½" DXS Quiet Ultra Duty Air Impact Wrench - 2" Extended Anvil	29
153-77412	CP-7741-2	1/2" Drive Heavy Duty Air Impact Wrench	30
157-03254	A874	Conical Eraser Pads	31
158-11873	A873CK	Composite Low Speed Tire Buffer w/ Quick Change Slip Chuck	22
163-00440	STS4-4PC-MM	1/2" Drive 4 Pc. Metric Ultimate Torque Socket Set	47
168-01224	NS-F4243RD	1/2" Drive 24" Breaker Bar	189
168-04994	SO4994	1" Drive 4 Pc. Heavy Duty Torque Socket Set	44
175-00041	A41H	1/2" Standard Anvil for IR2236QTiMAX Impact Wrench	29
175-00042	AK42H	2 pc. Anvil Set for IR2236QTiMAX Impact Wrench - 1/2" x 2" Extended & 3/4" Standard	29
175-00061	A61H	3/4" Standard Anvil for IR2236QTiMAX Impact Wrench	29
175-00062	AK62H	2 pc. Anvil Set for IR2236QTiMAX Impact Wrench -1/2" Standard & 3/4" Standard	29
175-00066	EA66H	3/4" x 6" Anvil for IR2236QTiMAX Impact Wrench	29

www.ascotsupply.com

⚠ WARNING: For more information go to www.P65Warnings.ca.gov.

2025 **NEW** PRODUCT DIRECTORY

ASCOT NO.	MFG. NO.	PRODUCT	PG.
175-00142	EA42H	1/2" x 2" Extended Anvil for IR2236QTiMAX Impact Wrench	29
175-00162	EAK62H	2 pc. Anvil Set for IR2236QTiMAX Impact Wrench -3/4" Standard & 3/4" x 6" Extended	29
175-23104	JB-04Pink	Pink Protective Boot for Impact Wrenches	28
302-02811	2811	1500 LB. High Reach Jack Stand	61
302-02812	2812	2-Ton Underhoist Tripod Jack Stand	62
302-28112	2811B	1500 LB. High Reach Jack Stand W/ Foot Pedal	61
302-63030	63030	Ascot 3, 6 & 12-Ton Jack Stands	63
302-63060	63060	Ascot 3, 6 & 12-Ton Jack Stands	63
302-63120	63120	Ascot 3, 6 & 12-Ton Jack Stands	63
309-00405	TJP4-Y	Rubber Jack Pads for Tesla Model Y Vehicles - Set of 4	180
312-07179	CP-RI79	LED Rechargeable Pen Light	193
313-00385	NS-WE385	Universal Chrome Wrench Extender	189
319-00012	TD12	12-Pc Tap & Die Set for Wheel Studs & Nuts	55
319-00033	AS-3ALB	Lug Nut Cover Wrench	87
319-00033	AS-3ALB	6 PC. Inflatable Air Wedge Bag Kit	88
319-01337	A337	7" Diagonal Cutting Pliers	202
319-01358	A358	8" Cutting Plier with End Cutter	202
319-01447	A447	7.75" Curved Diagonal Cutting Pliers	202
319-02080	AS2080	Gasket Scraper - Overall Length - 9-3/4"	189
319-02081	AS2081	Long Gasket Scraper - Overall Length - 12"	189
319-46464	AS-MHPS	Hook And Pick Set	142
319-76403	AS-876404	Professional 4 Pc. Pry Bar Set	88



486-31285
4-Slot Wheel Weight Roll Stand Conversion Kit

2025

NEW PRODUCT DIRECTORY



721-63001
Heavy Duty
Work Bench



319-46464
Hook And Pick Set

ASCOT NO.	MFG. NO.	PRODUCT	PG.
319-76403	AS-876404	Professional 4 Pc. Pry Bar Set	189
322-90045	FS9004-5L	Truck & Trailer Wheel Pan	184
371-03321	HJ3321	1/2-Ton Two-Stage Telescopic Transmission Jack	62
396-00003	3P-RETK	3-Piece Roadside Emergency Triangle Kit	75
396-00357	NS-KP480320	EVA Foam Kneeling Pad	78
396-95055	95055	Mag-Bear 25' Magnetic Retractable Barrier	192
402-46300	460 300	Multi-Cleaner Tool Kit	85
402-46340	460 340	40mm x 110mm Replacement Pads - 2-Pack	85
402-46350	460 350	50mm x 110mm Replacement Pads - 2-Pack	85
421-71750	71750	Portable Tire Press	93
427-01322	MBB	Martins Slide Hammer Bead Breaker	90
429-10005	AS-BBH5	5 lb. Bead Breaker Hammer	93
429-10010	AS-BBH10	10 lb. Bead Breaker Hammer	93
429-32344	AS-32FGH	32" Fiberglass Replacement Hammer Handle	94
432-02088	2088	Ascot White Tire Mounting Paste, 22 lb. Pail	109
432-12046	2046B	Bracket for Ascot White Tire Mounting Paste	109
432-12067	2067B	Bracket for Ascot Low Profile White Tire Mounting Paste	109
444-23614	TC181354	23.6" Bead Lifting Tool w/ Enhanced Grip	104
444-59408	AE5009408	Grip-Max Inserts	103
448-93500	93500	OTR EM Rim Flange Clamp	92
454-06763	676-3	PCD Wheel Bolt Measuring Tool	146
454-11410	ASN-1410	Aluminum OTR Tire Tread Depth Gauge	146

ASCOT NO.	MFG. NO.	PRODUCT	PG.
468-00149	VC7	Large Bore Hex Valve Cap	129
468-00401	SMTV03	Tank Valve	138
468-01765	AS-VC3	Metal Dome Valve Cap	129
468-09002	9002	Nickel Plated Valve Cores	130
468-74920	A17-492T-1	Grey Plastic TPMS Valve Cap W/ Seal	129
469-00024	VTC-018-24	Cable Type Valve Fishing Tool - 24"	141
469-00123	AS-123	Standard Bore valve cap installation/removal tool	144
469-00443	AS-443	3-In-1 Valve Extractor & Inflator Tool	141
469-01690	AS-690	Large Bore 4-Way Valve Core Tool	140
469-08288	VCT-031	Valve Core Torque Tool	142
469-11710	ASN-1710	Large Bore Core Tool 10" Length	140
476-11250	AS-250	Large Bore High Pressure Air Gauge	152
486-31283	WWRR-1	Single Roll Wheel Weight Wire Hanger	164
486-31284	WWRR-2	Double Roll Wheel Weight Wire Hanger	164
486-31285	WWR-2	4-Slot Wheel Weight Roll Stand Conversion Kit	164
486-48301	GTF-01	GT Force Two-In-One Wheel Weight Application And Removal Tool	175
486-71512	AS-002	Red Heavy Duty Adhesive Wheel Weight Scraper - 10.4" Length	175
491-11001	LN-01	LN-01 14MM x 2" Big Bulge, Ford 13/16" Hex	46
491-11002	LN-02	LN-02 12MM x 1.50" Bulge Acorn, Accura/Honda 3/4" Hex	46
491-11003	LN-03	LN-03 14MM x 1.50" Duplex Bulge Acorn, Dodge/Jeep/Ram 7/8" Hex	46
491-11004	LN-04	LN-04 14MM x 1.50" Duplex Bulge, GM 7/8" Hex	46

2025

NEW PRODUCT DIRECTORY



469-00443
3-In-1 Extractor & Inflator Tool



396-95055
AME Mag-Bear
25' Magnetic
Retractable Barrier

2025 NEW PRODUCT DIRECTORY

131-01750

1/4" 5-In-1 Universal
Safety Exhaust
Quick Connect
Female Coupler



153-22360

1/2" Ultra Duty Titanium
Air Impact Wrench

ASCOT NO.	MFG. NO.	PRODUCT	PG.
491-11005	LN-05	LN-05 9/16"-18 Duplex Bulge Acorn, Dodge/Jeep/Ram 7/8" Hex	46
491-11006	LN-06	LN-06 1/2"-20 Bulge Acorn, 13/16" Hex	46
491-11007	LN-07	LN-07 12MM x 1.25" Bulge Acorn, 13/16" Hex	46
491-11008	LN-08	LN-08 12MM x 1.50" Bulge Acorn, 13/16" Hex	46
491-11009	LN-09	LN-09 12MM x 1.25" Bulge Med Mag w/Washer, Nissan 13/16" Hex	46
491-11010	LN-10	LN-10 12MM x 1.50" Bulge Med Mag w/Washer, Toyota 13/16" Hex	46
491-11011	LN-11	LN-11 14MM x 1.50" Duplex Mag w/Washer, Toyota 7/8" Hex	46
491-11012	LN-12	LN-12 12MM x 1.50" Chrysler Mag 3/4" Hex	46
491-11013	LN-13	LN-13 1/2"-20 Bulge Acorn, 3/4" Hex	46
491-11014	LN-14	LN-14 12MM x 1.50" Ford 13/16" Hex	46
491-11015	LN-15	LN-15 12MM x 1.50" Bulge Acorn, 3/4" Hex	46
491-11016	LN-16	LN-16 12MM x 1.25" Bulge Acorn, 3/4" Hex	46
491-11017	LN-17	LN-17 12MM x 1.25" Cone Lug Bolt, 19mm Hex	46
491-11018	LN-18	LN-18 14MM x 1.50", Ford 13/16" Hex	46
491-11020	LN-20	14mm x 1.50" Short Truck 7-Spline Lug Nut	46
491-11021	LN-21	12mm x 1.50" Spline 6-Sided Lug Nut	46
491-11022	LN-22	12mm x 1.25" Spline 6-Sided Lug Nut	46
491-11023	LN-23	1/2"-20 Spline 6-Sided Lug Nut - Black	46
491-11024	LN-24	14mm x 1.50" Bulge Acorn 2 Pc. Lug Nut - 3/4" Hex - Black	46
491-11025	LN-25	12mm x 1.50" Bulge Acorn 2 Pc. Lug Nut - 3/4" Hex - Black	46

www.ascotsupply.com

WARNING: For more information go to www.P65Warnings.ca.gov.

ASCOT NO.	MFG. NO.	PRODUCT	PG.
491-11026	LN-26	12mm x 1.50" Spline 6-Sided Lug Nut - Black	46
491-11027	LN-27	12mm x 1.50" Spline 6-Sided 2-Pc. Lug Nut	46
491-11028	LN-28	12mm x 1.50" Open End Bulge Acorn Lug Nut - 3/4" Hex - Zinc	46
491-11029	LN-29	14mm x 1.50" Open End Bulge Acorn Lug Nut - 3/4" Hex - Zinc	46
491-11030	LN-30	1/2"-20 Open End Bulge Acorn Lug Nut - 3/4" Hex - Zinc	46
491-11031	LN-31	14mm x 1.50" Black Ford Heavy Duty Lug Nut	46
491-11031	LN-31	14mm x 1.50" Black Ford Heavy Duty Lug Nut	46
491-11032	SA-01	6-Spline Car Adapter - 3/4" & 13/16" Drive	46
491-11033	SA-02	7-Spline Truck Adapter - 7/8" & 13/16" Drive	46
491-11035	LN-35	12mm x 1.25" Subaru Nut 3/4" Hex	46
491-11036	LN-36	12mm x 1.25" Acorn Seat Jeep Lug Bolt - 17mm Hex	46
491-11038	LN-38	12mm x 1.50" Toyota (Long) - 13/16" Hex	46
491-11039	LN-39	12mm x 1.50" Bulge Acorn 3/4" Hex	46
491-11133	SN33B35.1	33mm Skirted Nut	54
537-00083	PHT-083A	Color Coded Tire Injury Measuring Tool	198
721-63001	TWB63001	1600 Lb. Capacity Heavy Duty Work Bench w/ Leveling Feet	211

2025

NEW PRODUCT DIRECTORY



175-23104
Pink Protective Boot



153-77412
1/2" Heavy Duty Air Impact Wrench

FILTERS, REGULATORS & LUBRICATORS



111-30002

GENERAL PURPOSE FILTERS

- Prevents corrosive damage to compressed air equipment and finished products
- Protects components and air tools from premature failure
- Porous sintered bronze element
- Installed upstream of regulators to prevent valve failure
- Removes harmful water condensate, pipe scale, dirt and rust from your compressed air system
- Also used as pre-filters to oil removing and coalescing filters to ensure high efficiency and long element life in applications such as paint spraying, instrumentation and pharmaceuticals



111-35201

Ascot No.	Mfg. No.	Pipe Size	Max. SCFM	Bowl Capacity	Bowl Type	Drain	Operating Temp.	Max. Flow	Filter Element
111-30002	F300-02	1/4"	27	1 oz.	Poly	Manual	40°-125°F	150 psig	20 micron
111-35201	F352W	1/4"	48	6 oz.	Metal	Manual	40°-160°F	250 psig	40 micron
111-35203	F352FW	1/4"	48	6 oz.	Metal	Float Auto	40°-120°F	175 psig	40 micron
111-35301	F353W	3/8"	75	5 oz.	Metal	Manual	40°-160°F	250 psig	40 micron
111-35401	F354W	1/2"	100	6 oz.	Metal	Manual	40°-160°F	250 psig	40 micron
111-35403	F354FW	1/2"	100	6 oz.	Metal	Float Auto	40°-120°F	175 psig	40 micron
111-37600	F376W	3/4"	230	10 oz.	Metal	Manual	40°-160°F	250 psig	40 micron



112-00352

REGULATORS

- Specialized control valve reduces upstream supply pressure level to a specified constant downstream pressure
- Regulates air pressure of the air line
- Reinforced diaphragm for repeated accuracy
- Self-relieving style units
- **ADJUSTMENT KNOB FEATURES THREE POSITION NON-RISING KNOB:** Push to lock, pull to adjust, detach to make tamper resistant
- Available in T-handle or adjustment knob

Ascot No.	Mfg. No.	Pipe Size	Max. Flow SCFM	Adjustment Type	Pressure Gauge Part No.	Gauge Port	Operating Temp.	Operating Pressure
112-00162	R162	1/4"	25	Adjustment Knob	117-01681*	1/8" NPT	40°-120°F	5-125 psig
112-00352	R352	1/4"	50	Adjustment Knob	117-01481*	(2) 1/4" NPT	40°-120°F	5-125 psig
112-00376	R376T	3/4"	220	T-Handle	117-01481*	(2) 1/4" NPT	40°-120°F	5-125 psig
112-01352	R352T	1/4" Regulator - T-Handle						
112-01354	R354GH	1/2" High Pressure Regulator - 10-250 Psi.						

*NOTE: Gauge not included. Sold separately. Ascot part number indicated.



113-01352

LUBRICATORS

- Injects a fine stream of oil into the air stream to automatically lubricate air operated tools and other devices
- Extends life of downstream components
- Precise control of oil feed with needle valve adjustment knob
- Adds minimal pressure drop to the air system
- FEATURES THREE POSITION NON-RISING KNOB: Push to lock, pull to adjust, detach to make tamper resistant
- High air flow
- Precise visual adjustment control
- Low flow to establish drip rate
- W is with sight glass and metal bowl

Ascot No.	Mfg. No.	Pipe Size	Max. Flow SCFM	Bowl Capacity	Bowl Type	Operating Temp.	Max. Pressure	Oil Delivery
113-01352	L352W	1/4"	16	5 oz.	Metal	40°-175°F	200 psig	2 scfm
113-01354	L354W	1/2"	142	5 oz.	Metal	40°-175°F	200 psig	2 scfm

FILTERS, REGULATORS & LUBRICATORS

MODULAR UNITS

- Units include a filter, regulator and lubricator and or filter, regulator and oil removing filter
- Units equipped with or without OSHA safety lock-out valves
- Screwdriver is the only tool needed to connect or disconnect units
- Insert interlocking feature allows simple installation in any location
- **Gauge included**

Ascot No.	Mfg. No.	Pipe Size	Max. Flow SCFM	Bowl Capacity	Bowl Type	Drain	Lockout Valve	Operating Temp.	Max. Pressure
114-03352	C33352W	1/4"	100	6 oz.	Metal	Manual	Not Included	40-175° F	250 psi
114-03354	C33354W	1/2"	100	6 oz.	Metal	Manual	Not Included	40-175° F	250 psi
114-13354	VC33354W	1/2"	100	6 oz.	Metal	Manual	Included	40-175° F	250 psig



114-03354
Modular Unit

FILTER/REGULATOR COMBINATION UNITS

- Combines filter and pressure regulator into one space saving unit
- Output performance equal to an individual filter and regulator
- Reduced pressure outputs of 0-125 psig
- **FEATURES THREE POSITION NON-RISING KNOB:** Push to lock, pull to adjust, detach to make tamper resistant
- *Available in metal bowl or polycarbonate bowl with metal bowl guard*

Ascot No.	Mfg. No.	Pipe Size	Adjustment Type	Max. Flow SCFM	Bowl Capacity	Bowl Type	Drain	Gauge Part No.	Operating Temp.	Max. Pressure
114-75400	B754T	1/2"	T-Handle	100	5 oz.	Poly	Manual	117-01481	40-125° F	150 psig
114-75202	B752FW	1/4"	Knob	50	6 oz.	Metal	Auto	117-01481	40-125° F	175 psig



114-75400
Filter/Regulator Combination Unit

*NOTE: Gauge not included. Sold separately. Ascot part number indicated.

FILTER, REGULATOR & LUBRICATOR ACCESSORIES

Ascot No.	Mfg. No.	Description
117-11481	1481B	1/4" Back Mount Gauge - 0-300 PSI



117-11481
1/4" Back Mount Kit

ELECTRIC AUTOMATIC COMPRESSOR DRAIN

- Automatically drains filters, compressor tanks, drip legs, aftercoolers and receivers
- Opens and closes valve in 1 to 60 minute cycle times and 1 to 30 second blow down time
- 1/4" NPT connection
- **Includes Y-strainer**

Ascot No.	Mfg. No.	Description
117-05702	5702S	1/4" Automatic Compressor Drain



117-05702
Electric Automatic Compressor Drain

PANEL MOUNT KIT

- For use with piggyback and regulators
- Bracket can be securely mounted to surface through holes on L shaped bracket
- Includes threaded nut that holds piggyback to bracket
- For 1/4", 3/8" and 1/2" national pipe thread piggybacks
- **Made in USA**

Ascot No.	Mfg. No.	Description
117-00935	PMKR35	Panel Mount Kit



117-00935
Panel Mount Kit

AIR HOSES & ACCESSORIES

125-00760
3/8" Air
Hose Reel



126-00761
1/2" Air
Hose Reel

AIR HOSE REELS

- Mounting base is slotted and roller arm has 5 positions for multiple mounting configurations.
- Heavy steel construction adds durability and longer life cycles
- Rubber air hose with heavy-duty crimping and spring guard ensure longevity
- Automatic return via heavy-duty sealed spring with 8 locking stops, roller guide and ball stop
- 300 PSI maximum pressure
- Ship weight 40 lbs



Ascot No.	Mfg. No.	Description
125-00760	760	3/8" X 50 Air Hose Reel
126-00761	761	1/2" X 50 Air Hose Reel



121-01225
Coupled
Air Hose



121-03825
Coupled
Air Hose

COUPLED AIR HOSES

- 325 PSI
- EPDM abrasion resistant cover
- Reinforced with heavy duty polyester cord
- Bend restrictors both ends
- Premium machined brass alloy fittings
- -40°F to +200°F
- **MADE IN THE USA**

Ascot No.	Mfg. No.	Description
121-01225	98101646	Coupled 1/2" x 25' Reinforced Domestic Air Hose
121-01250	98101648	Coupled 1/2" x 50' Reinforced Domestic Air Hose
121-03825	98101640	Coupled 3/8" x 25' Reinforced Domestic Air Hose
121-03851	98101642	Coupled 3/8" x 50' Reinforced Domestic Air Hose



121-14700
1/4" Bulk
Domestic
Air Hose



1/4" BULK DOMESTIC AIR HOSE

- 1/4" ID x 325 PSI
- **TEMP RANGE:** -40°F to +200°F
- Multi-spiral polyester yarn reinforcement makes hose easy to handle and very flexible
- Used in numerous industrial, agricultural and construction applications
- EPDM tube and cover resists abrasion, heat and ozone
- **MADE IN THE USA**

Ascot No.	Mfg. No.	Description
121-14700	91008400	1/4" x 700' Domestic Bulk Air Hose (325 PSI) Reel



137-11420
Red Handled
Hose Cutter
Aluminum

RED HANDLED HOSE CUTTER

- **Powder coated aluminum body**
- Heat treated stainless steel cutting blade
- Ø3-36 mm rubber and reinforced hose cutter
- Locking mechanism for safe storage

Ascot No.	Mfg. No.	Description
137-11420	A11-420	Red Handled Hose Cutter

AIR HOSES & ACCESSORIES

3/8" BLUE COIL HOSE

- 25' length
- 1/4" x 3/8" fittings
- 150 PSI
- Polyurethane tubing
- Excellent abrasion resistance
- Highly kink-resistant, withstands twisting or crushing
- **EASY TO HANDLE:** 25% lighter than rubber
- Made in Taiwan

Ascot No.	Mfg. No.	Description
123-13825	3/8x25	25' Blue Coil Hose - 1/4" x 3/8" Fittings - 150 PSI

BLUE RECOIL AIR HOSE

- Highly kink-resistant, withstands twisting or crushing
- Swivel fittings
- 150 PSI
- Polyurethane tubing
- Excellent abrasion resistance
- **EASY TO HANDLE:** 25% lighter than rubber

Ascot No.	Mfg. No.	Description
123-14012	1/4x1/4x1/4x12	1/4" Blue Recoil Air Hose - 1/4" x 1/4" Swivel Fittings (12' Length)
123-14025	1/4x1/4x1/4x25	1/4" Blue Recoil Air Hose - 1/4" x 1/4" Swivel Fittings (25' Length)
123-38050	3/8x1/4x1/4x50	3/8" Blue Recoil Air Hose - 1/4" x 1/4" Swivel Fittings (50' Length)
123-38125	3/8x3/8x3/8x25	3/8" Blue Recoil Air Hose - 3/8" x 3/8" Swivel Fittings (25' Length)

GAUGE VALVE SET FOR PORTABLE AIR TANKS

Ascot No.	Mfg. No.	Description
107-00125	NS125DM	Gauge & Valve Set for Portable Air Tank

5-GALLON PORTABLE AIR TANK

- Perfect for emergency tire inflation • 125 PSI maximum pressure with manifold provides plenty of usable air for inflation tasks • 4' hose and ball foot air chuck makes it easier to get to hard-to-reach areas • Drain port included for regular draining to help eliminate rust and to help stop compressor generated water from flowing down the air line • Heavy duty steel gauge construction • Easy to read steel pressure gauge • Powder coated finish • Made in China

Ascot No.	Mfg. No.	Description
107-69102	91002ASC	5-Gallon Portable Air Tank

RPG HIGH PERFORMANCE BLOW GUN KIT

- Power to clean workshops, equipment and more
- Comfortable pistol grip for maximum comfort and control
- Aluminum is lightweight and corrosion-resistant to guarantee long term use
- Produces more air flow than standard blow guns, fits any hose with 1/4" NPT thread, variable flow trigger provides precise control
- Maximum working pressure 120PSI
- Nozzles are OSHA standard with increased air delivery and the rubber tip protects delicate surfaces from damage
- Kit includes high performance blow gun, ultimate flow tip, rubber tip, quiet flow nozzle, 6" extension, 3" needle and reducer

Ascot No.	Mfg. No.	Description
128-00006	HPBGK-7	RPG 7-Piece High Performance Blow Gun Kit



AIR HOSES & ACCESSORIES



131-01750



1/4" 5-IN-1 UNIVERSAL SAFETY EXHAUST QUICK CONNECT FEMALE COUPLER

- Designed to safely bleed off air pressure before releasing the connector
- Allows for safe disconnection, eliminating potentially dangerous hose whip
- Coupler remains connected to the plug while pressurized air is safely bled off
- Constructed of heavy-duty steel which is ideal for applications requiring a durable and long lasting pneumatic coupler
- Connects to all major interchanges: Industrial (M-style), High flow (v-style), automotive (t-style), Aro (A-style), and Lincoln (L-Style).

Ascot No.	Mfg. No.	Description
131-01750	1750BK	1/4" 5-In-1 Universal Safety Exhaust Quick Connect Female Coupler



131-61523



131-61526



COUPLERS

- All 1/4" couplers are constructed out of solid brass bar and 1/2" coupler is out of steel bar
- Proven ball locking mechanism with stainless steel ball bearings evenly distribute the load to resist wear and provide positive connections
- High flow steel valves
- Integral sleeve guard protects the sleeve and resists accidental disconnects
- Knurling and/or grooves on the sleeve provide a gripping surface for ease of operation



131-61573



131-62523



133-61563

Ascot No.	Mfg. No.	Description
131-61523	785	Auto Type C Female Coupler: 1/4" Body 1/4" NPT
131-61526	775	Aro Style Female Coupler: 1/4" Body 1/4" NPT
131-61573	715	Ind. Type D Female Coupler: 1/4" Body 1/4" NPT
131-62523	D-13R	Ring-Type Auto Type C Female Coupler: 1/4" Body 1/4" NPT
133-61563	1815	Auto Type F Female Coupler: 1/2" Body 1/2" NPT
133-61471	D-17R	Ring-Type Auto Type F Female Coupler: 1/2" Body 1/2" NPT



131-61527



131-61529



131-61538

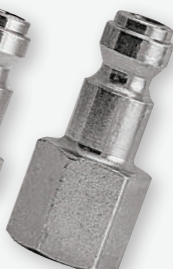

131-61539

PLUGS

- All plugs are machined out of steel bar
- Precision machined surfaces and hardened load bearing areas resist the efforts of mechanical shock in the most rugged applications
- Hardened wear points provide long service life



131-61578

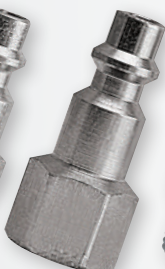

131-61579



133-01855



133-61568



133-61569

Ascot No.	Mfg. No.	Description
131-61527	777	Aro Style Male Plug: 1/4" Body 1/4" NPT
131-61529	778	Aro Style Female Plug: 1/4" Body 1/4" NPT
131-61538	783	Auto Type C Male Plug: 1/4" Body 1/4" NPT
131-61539	784	Auto Type C Female Plug: 1/4" Body 1/4" NPT
131-61578	727	Ind Type D Male Plug: 1/4" Body 1/4" NPT
131-61579	728	Ind Type D Female Plug: 1/4" Body 1/4" NPT
133-01855	1855	G-Style Male Plug: 1/2" Body 1/4" NPT
133-61568	1817	Auto Type F Male Plug: 1/2" Body 1/2" NPT
133-61569	1818	Auto Type F Female Plugs: 1/2" Body 1/2" NPT

AIR HOSES & ACCESSORIES

FEMALE RECAP PLUG

- Case hardened steel, plated to resist rust
- **MAXIMUM INLET PRESSURE:** 300 PSI
- **MAXIMUM TEMPERATURE:** 250° F
- **AIR FLOW:** 40 SCFM

Ascot No.	Mfg. No.	Description
131-61531	731	M-Style Female Recap Plug: .305-32



131-61531
Female Recap Plug

HYDRAULIC COUPLERS

- High-flow hydraulic coupler, 10,000 PSI working pressure
- **Made in Italy**

Ascot No.	Mfg. No.	Description
135-10605	PVV-38-M	3/8" Male Hose Half Coupler - For Hydraulic Rams
135-10606	PVV-38-F	3/8" Female Ram Half Coupler - For Hydraulic Rams
135-10607	N/A	Hydraulic Coupler Set - (1) Male & (1) Female



135-10605
3/8" Male Hose Half Coupler



135-10606
3/8" Female Ram Half Coupler

HYDRAULIC QUICK CONNECT COUPLER/PLUG

- **10,000 PSI maximum operating pressure**
- Safety sleeve lock prevents accidental disconnection
- Heavy duty back-up ring prevents o-ring extrusion
- Heat treated and plated steel for greater wear and corrosion resistance
- Self-sealing poppet valves provide excellent high and low pressure seating
- **Coupler equivalent to Parker TC-371, AME TC-371 & ESCO 10626**
- **Plug equivalent to Parker TC-372, AME TC-372 & ESCO 10625**
- **Made in Italy**

Ascot No.	Mfg. No.	Description
135-11606	FD35-1001-0606	Hydraulic Quick Connect Coupler
135-12606	FD35-1002-0606	Hydraulic Quick Connect Plug



135-11606
Hydraulic Quick Connect Coupler



135-12606
Hydraulic Quick Connect Plug

RUBBER DUST COVER FOR HYDRAULIC COUPLERS

- Hydraulic coupler dust cap
- Used to keep dirt and debris from your hydraulic coupler when not connected
- Made of a durable rubber material
- Equipped with a pre-slit ring to allow coupler to slide easily over the counter
- **Comes standard with 8' and 10' hydraulic hoses**

Ascot No.	Mfg. No.	Description
319-03732	03-RDC	Rubber Dust Cover for Hydraulic Couplers



319-03732
Rubber Dust Cover for Hydraulic Couplers

AIR HOSES & ACCESSORIES

136-71406
3/8" Hose Splicer



136-71408
1/2" Hose Splicer



136-71440
1/4" Hose Splicer



136-71606
Standard Male
Hose Barb Fitting



136-72404
Standard Female
Hose Barb Fitting



BRASS HOSE SPLICERS

- Brass multipurpose rigid barbed hose menders repair and connect damaged hoses
- They provide good strength, ductility, and corrosion resistance

Ascot No.	Mfg. No.	Description
136-71406	07014-06	3/8" Hose Splicer
136-71408	07014-08	1/2" Hose Splicer
136-71440	07014-04	1/4" Hose Splicer

STANDARD MALE HOSE BARB FITTINGS

- Select fitting to match hose ID
- Fittings must be secured to hose with either a hose clamp or crimped-on ferrule

Ascot No.	Mfg. No.	Description
136-71404	07001-0404	1/4" x 1/4" Hose Barb
136-71604	07001-0604	3/8" x 1/4" Hose Barb
136-71606	07001-0606	3/8" x 3/8" Hose Barb
136-71806	07001-0806	1/2" x 3/8" Hose Barb
136-71808	07001-0808	1/2" x 1/2" Hose Barb

STANDARD FEMALE HOSE BARB FITTING

Ascot No.	Mfg. No.	Description
136-72404	07002-0404	1/4" x 1/4" Female Hose Barb

AIR HOSES & ACCESSORIES

2-EAR CLAMPS

- Specially suited for industrial or heavy vibrating equipment
- Medium pressure clamp that is used for maintenance and OEM applications
- Rubber hose, plastic tubing, coaxial and electrical cable, rope are easily clamped
- **APPLICATIONS:** For air, fluid, gas, steam line



Ascot No.	Mfg. No.	Nominal Size	Inches Closed-Open	MM Closed-Open	Inner Inches	Width of Ear
316-00911	911	7/16"	.355-.433"	9-11 mm	.276"	7.0 mm
316-01113	1113	1/2"	.433-.512"	11-13 mm	.276"	7.0 mm
316-01315	1315	9/16"	.512-.591"	13-15 mm	.295"	7.5 mm
316-01518	1518	5/8"	.591-.708"	15-18 mm	.315"	8.0 mm
316-01720	1720	3/4"	.669-.787"	17-20 mm	.335"	8.5 mm
316-01922	1922	13/16"	.748-.866"	19-22 mm	.354"	9.0 mm
316-02023	2023	7/8"	.787-.905"	20-23 mm	.354"	9.0 mm



316-91098
2-Ear Clamp Service Kit

2-EAR CLAMP SERVICE KIT

- **SERVICE KIT CONTAINS THE FOLLOWING SIZES:** (15) 5/16"; (15) 7/16"; (15) 1/2"; (15) 9/16"; (12) 5/8"; (12) 3/4"; (12) 7/8"; (12) 15/16"; (12) 1"; and (1) pair straight jaw pliers

Ascot No.	Mfg. No.	Description
316-91098	SK1098	Service Kit
316-01098	1098	Straight Jaw Pincer



316-00102
Handheld Pinch Clamp Crimper

Pinch Clamp

PINCH CLAMPS

- Made from stainless steel
- Feature a specialized tongue-in-groove design to provide a tight, secure seal
- Tamper evident design
- Ideal for both flexible and inflexible thin-walled hoses
- Smooth-edged bandsteel design prevents damage to hoses

Ascot No.	Mfg. No.	Description
316-00058	PEC58	5/8" Pinch Clamp
316-00102	CSC-102	Handheld Pinch Clamp Crimper

AIR TOOLS & ACCESSORIES

158-11873
Composite
Low Speed
Tire Buffer w/
Quick Change
Slip Chuck



**COMPOSITE LOW SPEED TIRE BUFFER
W/ QUICK CHANGE SLIP CHUCK**

- Composite body
- Brass bushings provide performance and durability in tough working conditions
- Quick change slip chuck for fast and easy change of buffing wheel
- Lock-off throttle to prevent accidental start ups
- Rear exhaust directs air away from the work area
- Built-in regulator
- Ideal for patchwork, roughing areas for recapping and cleaning tire moldings
- Includes whip hose and exhaust hose
- Overhose Kit also Available Separately (175-00873)
- **FREE SPEED: 2800 RPM**
- Similar to CP873CK
- Made in Taiwan



Ascot No.	Mfg. No.	Description
158-11873	A873CK	Composite Low Speed Tire Buffer w/ Quick Change Slip Chuck

**LOW SPEED TIRE BUFFER WITH
QUICK CHANGE SLIP CHUCK**

- Brass bushings provide performance and durability
- Quick change slip chuck for fast and easy change of buffing wheel
- Lock-off throttle to prevent accidental start ups
- Rear exhaust directs air away from the work area
- Built-in regulator
- Ideal for patchwork, roughing areas for recapping and cleaning tire moldings
- *Includes whip hose and exhaust hose*
- *Overhose Kit also Available Separately (175-00873)*
- **FREE SPEED: 2800 RPM**
- **Made in Taiwan**
- **Similar to CP873K**



158-10873
Low Speed
Tire Buffer with
Quick Change
Slip Chuck

Ascot No.	Mfg. No.	Description
158-10873	A873K	Low Speed Tire Buffer with Quick Change Slip Chuck

AIR TOOLS & ACCESSORIES

HIGH SPEED TIRE BUFFER WITH OVERHOSE KIT

- Jacobs chuck for holding buffing accessories
- Lock-off throttle
- **FREE SPEED:** 22,000 RPM
- **APPLICATIONS:** Tire patchwork, roughing areas for recapping and cleaning tire moldings
- *Includes overhose kit*



158-10871
High Speed
Tire Buffer with
Overhose kit

Ascot No.	Mfg. No.	Description
158-10871	A871K	High Speed Tire Buffer with Overhose Kit

HIGH SPEED BUFFER KIT WITH QUICK-CHANGE CHUCK

- Quick-change chuck for holding buffing accessories
- Lock-off throttle
- **FREE SPEED:** 22,000 RPM
- **APPLICATIONS:** Tire patchwork, roughing areas for recapping and cleaning tire moldings
- *Includes overhose kit*
- **Made in Taiwan**



158-11871
High Speed
Tire Buffer Kit
with Quick-
Change Chuck

Ascot No.	Mfg. No.	Description
158-11871	A871K-QC	High Speed Buffer Kit with Quick Change Chuck

PARTS FOR AIR BUFFERS

Ascot No.	Mfg. No.	Description
175-00873	A-873K-OH	Overhose Kit for Tire Buffers
175-18713	A8713-TA	Trigger Assembly for Tire Buffers
175-28713	SQC01	Replacement 7/16" Quick Change Slip Chuck



175-18713
Trigger Assembly
for Tire Buffers



175-28713
Replacement 7/16"
Quick-Change Slip Chuck



175-00873
Overhose Kit
for Tire Buffers

AIR TOOLS & ACCESSORIES



155-77826
1" Heavy Duty Air Impact Wrench



155-17782
#5 Spline Drive Air Impact Wrench

1" HEAVY DUTY AIR IMPACT WRENCH

- 2140 ft./lb. / 2900 Nm of maximum torque in reverse
- Pinless closed reinforced rocking dog impact mechanism
- Socket retainer ring combined with hole retainer
- Ergonomic side handle
- Full teasing trigger
- Regulator with integrated forward/reverse with 3-position power settings in both directions

Ascot No.	Mfg. No.	Description
155-77826	CP7782-6	1" Heavy Duty Air Impact Wrench
155-17782	CP7782SP-6	#5 Spline Drive Air Impact Wrench with 6" Extended Anvil



155-02856
1" Drive Heavy Duty Air Impact Wrench



156-28566
#5 Spline Drive Super Duty Air Impact Wrench

1" DRIVE HEAVY DUTY AIR IMPACT WRENCH

- Perfect for the demanding world of truck tire and service work
- Combines exceptional power, durability and operator convenience
- 360 degree swivel inlet
- 6" extended anvil
- Delivers 1450 ft./lb. of maximum torque with a 5000 RPM free speed and four-position power regulator

Ascot No.	Mfg. No.	Description
155-02856	IR285B-6	1" Drive Heavy Duty Air Impact Wrench
156-28566	IR285B-S6	#5 Spline Drive Super Duty Air Impact Wrench - 6" Anvil



1" DRIVE SUPER DUTY IMPACT WRENCH

- 6" extended anvil
- 3-position forward and reverse
- High efficiency 6-vane motor
- Swoop-back side handle for maneuverability and balance
- Pinless clutch mechanism
- **WORKING TORQUE RANGE:** 1,800-2,000 ft./lb.
- **FREE SPEED:** 5,000 RPM
- **MAXIMUM TORQUE:** 2,000 ft./lb.
- **Made in Taiwan**
- **Similar to IR285B-6**

Ascot No.	Mfg. No.	Description
155-12856	A2856	1" Drive Super Duty Impact Wrench

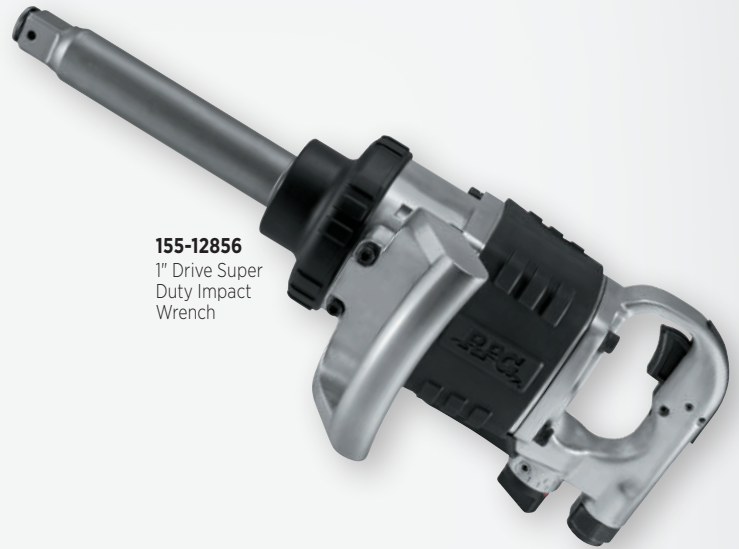

155-12856
1" Drive Super Duty Impact Wrench

1" DRIVE MINI PLUS IMPACT WRENCH

- 6" extended anvil
- 3-position power setting
- Rubber-coated side handle for added comfort
- Powered by the twin hammer clutch
- **FREE SPEED:** 5,000 RPM
- **MAXIMUM TORQUE:** 2,000 ft./lb.
- **Made in Taiwan**



Ascot No.	Mfg. No.	Description
155-26464	A26464	1" Drive Mini Plus Impact Wrench



155-26464
1" Drive Mini Plus Impact Wrench

1" DRIVE SUPER DUTY AIR IMPACT WRENCH

- 6" extended anvil
- Steel end plates
- **WORKING TORQUE RANGE:** 1,600-1,800 ft./lb.
- **FREE SPEED:** 4,500 RPM
- **MAXIMUM TORQUE:** 1,800 ft./lb.
- **Similar to CP7786-2**
- **Made in Taiwan**

Ascot No.	Mfg. No.	Description
155-17786	A778-6	1" Drive Super Duty Air Impact Wrench

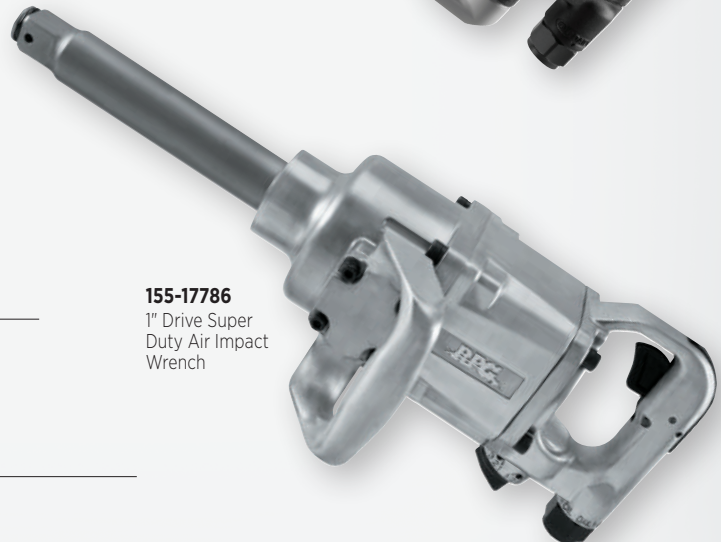

155-17786
1" Drive Super Duty Air Impact Wrench

PARTS FOR A778-6 IMPACT WRENCH

Ascot No.	Mfg. No.	Description
176-18406	A778-6TK	Tune-Up Kit for A778-6 1" Drive Impact Wrench

AIR TOOLS & ACCESSORIES



157-00874
High Speed
Cutter



HIGH SPEED CUTTER

- Adjustable speed regulator for precise control
- Lock-off throttle to prevent accidental start-up
- Rear exhaust directs air away from work area

Ascot No.	Mfg. No.	Free Speed (RPM)	Air Con. Avg (CFM)	Air Inlet (NPT)	Hose Size	Length	Wgt. (lb.)
157-00874	CP-874	22,000	1.4	1/4"	3/8"	7.25"	1.8

157-00875
Mini Angle
Die Grinder



MINI ANGLE DIE GRINDER

- Compact, lightweight design for easy maneuverability
- 90° angle head allows flexibility in confined areas
- Complete with 1/4" and 6mm collet
- Applications: High speed blending, smoothing, porting and deburring in confined areas

Ascot No.	Mfg. No.	Free Speed (RPM)	Air Con. Avg (CFM)	Air Inlet (NPT)	Hose Size	Length	Wgt. (lb.)
157-00875	CP-875	22,500	4	1/4"	3/8"	7.5"	1.1

158-01871
High Speed
Tire Buffer -
Tool Only



HIGH SPEED TIRE BUFFER

- Jacobs chuck for holding buffing accessories
- Lock-off throttle
- Applications: Tire patchwork, roughing areas for recapping and cleaning tire moldings

Ascot No.	Mfg. No.	Free Speed (RPM)	Air Con. Avg (CFM)	Air Inlet (NPT)	Hose Size	Length	Wgt. (lb.)
158-01871	CP-871	22,000	3.2	1/4"	3/8"	8"	1.8



158-03873
Low Speed
Tire Buffer
Tool Only

COMPOSITE LOW SPEED TIRE BUFFER

- Quick Change slip chuck for fast and easy change of buffing wheel
- Adjustable speed regulator for precise control
- Lock off throttle to prevent accidental start ups
- Rear exhaust directs air away from work area
- 3,000 RPM

Ascot No.	Mfg. No.	Description
158-03873	CP873C	Low Speed Tire Buffer



158-02873
Low Speed
Composite Tire
Buffer Kit



COMPOSITE LOW SPEED TIRE BUFFER KIT

- Perfect for every tire shop doing patchwork, roughing areas for recapping, and cleaning tire moldings
- Chuck Size: 7/16"
- Avg. Air Consumption: 4 CFM
- Air Inlet NPTF: 1/4"
- Min. Hose Size: 3/8"
- Free Speed: 2500 RPM
- Lock off throttle to prevent accidental start up
- Rear exhaust directs air away from work piece
- Built-in regulator matches speed to job

Ascot No.	Mfg. No.	Description
158-02873	CP873CK	CP Composite Low Speed Tire Buffer Kit



1/2" SUPER DUTY AIR IMPACT WRENCH WITH 2" EXTENDED ANVIL

- Most popular tool in its class
- Offers the sheer power and performance features to tackle the toughest of jobs
- Durable and economical
- **WORKING TORQUE RANGE:** 25-350 ft./lb.
- **Made in Taiwan**



153-02312
1/2" Super Duty Air-Impact Wrench with 2" Extended Anvil



Ascot No.	Mfg. No.	Square Drive	Free Speed (RPM)	Max Torque (ft./lb.)	Air Press. (PSI)	Air Con. Avg (CFM)	Air Inlet (NPT)	Hose Size	Length	Wgt. (lb.)
153-02312	IR231HA-2	1/2"	8000	590	90	4.2	1/4"	3/8"	7.3"	5.8



1/2" DRIVE SUPER DUTY AIR IMPACT WRENCH

- 2" extended anvil
- **FREE SPEED:** 8,000 RPM
- **MAXIMUM TORQUE:** 600 ft./lb.
- Powered by the durable and high performing twin hammer mechanism
- Proven design and the most popular configuration in the tire service industry
- Handle exhaust
- **Made in Taiwan**



153-23120
1/2" Drive Air Impact Wrench with 2" Extended Anvil



Ascot No.	Mfg. No.	Square Drive	Free Speed (RPM)	Max Torque (ft./lb.)	Air Press. (PSI)	Air Con. Avg (CFM)	Air Inlet (NPT)	Hose Size	Length	Wgt. (lb.)
153-23120	A2312	1/2"	8000	600	90	4	1/4"	3/8"	8-1/8"	5.6

AIR TOOLS & ACCESSORIES



153-12260
1/2" Drive Composite Impact Wrench with Extended Anvil

PUSH BUTTON FOR ONE-HAND OPERATION



1/2" DRIVE COMPOSITE IMPACT WRENCH W/ EXTENDED ANVIL

- Convenient one-hand operated forward/reverse push button
- Feather trigger for precise speed control
- Four-setting torque adjustment switch
- Energy efficient motor for maximum performance & long life
- Compact with a total length of only 7.2"
- Swivel air inlet prevents hose from twisting
- Twin hammer mechanism provides smooth balance

Ascot No.	Mfg. No.	Description
153-12260	A2131-2COM	1/2" Drive Composite Impact Wrench w/ Ext. Anvil



153-42235
1/2" Ultra Duty Titanium Impact Wrench with 2" Extended Anvil



1/2" ULTRA DUTY TITANIUM IMPACT WRENCH

- Titanium hammer case is designed to be strong and durable to protect the interior components
- Optimized for the vehicle repair industry, heavy trucks, tire lanes, fleet maintenance, body shops, general use, MRO, rail, heavy machinery, oil and gas, ship building and construction
- Impact and chemical-resistant housing protects against drops and exposure to shop fluids

Ascot No.	Mfg. No.	Description
153-02235	IR-2235TIMAX	1/2" Drive Ultra Duty Impact Wrench - Standard Anvil
153-22235	IR-2235QTIMAX-2	1/2" Drive QUIET Ultra Duty Impact Wrench - 2" Extended Anvil
153-42235	IR-2235TiMAX-2	1/2" Drive Ultra Duty Impact Wrench - 2" Extended Anvil



175-23104
Pink Protective Boot



PROTECTIVE BOOTS FOR IMPACT WRENCH

Ascot No.	Mfg. No.	Description
175-23104	JB-04Pink	Pink Protective Boot for Impact Wrenches



1/2" ULTRA DUTY TITANIUM AIR IMPACT WRENCH

- Patented Drive Xchange System™: Helps you get more versatility, torque, and control out of your impact wrench. With 3/8," 1/2", and 3/4" drive options and 5 different anvil lengths, you can do more work with less equipment
- Powerful Versatility: 1,500 ft.-lbs. of breakaway torque from a unique patented motor design
- Quiet: 4 decibels quieter running from a patented motor design
- Patented Direct Greasing System: Greasing your tool has never been easier. Directly grease the tool's hammer for more efficient operation and increased run time
- Reliable Performance: Stay working, and at peak power by quickly replacing worn or broken anvils
- Ergonomic: Smaller, lighter and better balanced design under 4.5 lbs. and 7.4" overall length



153-22360

153-22362



175-00041

175-00066

175-00042

175-00142

175-00061

175-00162

175-00062

ASCOT NO.	MFG. NO.	DESCRIPTION
153-22360	IR2236TiMAX	1/2" DXS Quiet Ultra Duty Air Impact Wrench - Standard Anvil
153-22362	IR2236TiMAX-2	1/2" DXS Quiet Ultra Duty Air Impact Wrench - 2" Extended Anvil
175-00041	A41H	1/2" Standard Anvil for IR2236QTiMAX Impact Wrench
175-00042	AK42H	2 pc. Anvil Set for IR2236QTiMAX Impact Wrench - 1/2" x 2" Extended & 3/4" Standard
175-00061	A61H	3/4" Standard Anvil for IR2236QTiMAX Impact Wrench
175-00062	AK62H	2 pc. Anvil Set for IR2236QTiMAX Impact Wrench - 1/2" Standard & 3/4" Standard
175-00066	EA66H	3/4" x 6" Anvil for IR2236QTiMAX Impact Wrench
175-00142	EA42H	1/2" x 2" Extended Anvil for IR2236QTiMAX Impact Wrench
175-00162	EAK62H	2 pc. Anvil Set for IR2236QTiMAX Impact Wrench - 3/4" Standard & 3/4" x 6" Extended

AIR TOOLS & ACCESSORIES

1/2" SUPER DUTY AIR IMPACT WRENCH

- **LIGHTWEIGHT:** Composite motor housing
- **DURABLE:** Twin hammer mechanism
- **ERGONOMIC:** NEW one-hand forward/reverse ring system
- Curved handle with rubber material
- Resistant to most chemicals used in workshops
- Does not slip in operator's hand



153-77482
1/2" Super Duty Air Impact Wrench with Extended Anvil

Ascot No.	Mfg. No.	Square Drive	Free Speed (RPM)	Max Torque (ft./lb.)	Air Press. (PSI)	Air Con. Avg (CFM)	Air Inlet (NPT)	Hose Size	Length	Wgt. (lb.)
153-77482	CP-7748-2	1/2"	8200	960	90	6.2	1/4"	3/8"	9.8"	5.1

1/2" DRIVE HEAVY DUTY AIR IMPACT WRENCH

- 3 power settings in forward providing more control over different applications
- Less heat transfer between the motor and the handle is provided thanks to its composite handle
- Lightweight & compact at 5.18 lbs. and 9.65 inches thanks to its aluminum clutch housing and composite handle
- 715 Ft./Lbs. of max torque in reverse
- 509 Ft./Lbs. of max torque in forward
- 10,000 RPM free speed



153-77412
1/2" Heavy Duty Air Impact Wrench

Ascot No.	Mfg. No.	Square Drive	Free Speed (RPM)	Max Torque (ft./lb.)	Air Press. (PSI)	Air Con. Avg (CFM)	Air Inlet (NPT)	Hose Size	Length	Wgt. (lb.)
153-77412	CP-7741-2	1/2"	10,000	509	90	5	1/4"	3/8"	9.65"	5.18

AIR TOOLS & ACCESSORIES

WHEEL WEIGHT ADHESIVE REMOVAL TOOL

- High torque motor to cut through stubborn wheel weight adhesive, body pinstripes, etc
- High RPM to prevent pad from bogging down
- Pad made of a tough and long-lasting material
- Rubber-insulated motor housing for hand comfort
- Lock-off trigger for added safety
- *Includes eraser pad*
- **SPINDLE THREAD:** 5/16"-24
- **Made in Taiwan**



Ascot No.	Mfg. No.	Description
157-03252	A143252	Wheel Weight Adhesive Removal Tool
157-03253	A143252-6	Replacement Eraser Pads for Wheel Weight Adhesive Removal Tool - 6 per package



157-03252
Wheel Weight Adhesive Removal Tool



157-03253
Replacement Eraser Pads for Wheel Weight Adhesive Removal Tool

CONICAL ERASER PADS

- 6 pads per box
- Adapter included
- Pad is made from a tough and long-lasting material
- Conical shape to remove wheel weight adhesive when used with our A143252 wheel weight adhesive removal tool as well as standard drills
- For best performance, use at 500 RPM's
- Similar to Matco MUCEKIT
- Made in Taiwan



Ascot No.	Mfg. No.	Description
157-03254	A874	Conical Eraser Pads



157-03254
Conical Eraser Pads



AIR TOOLS & ACCESSORIES

157-10874
3" Cut-Off Tool



157-10875
1/4" Mini Angle Die Grinder



157-01327
Low Speed Tire Buffer W/ Overhose Kit



157-01035
1/2" Air Drill with Quick Change Chuck & Exhaust Hose



TOP SELLER

175-11035
Air Hose Exhaust Kit



3" CUT-OFF TOOL

- Adjustable speed regulator for precise control
- Lock-off throttle to prevent accidental start-up
- **FREE SPEED:** 22,000 RPM
- Rear exhaust directs air away from work area
- Durable gears for top performance and long life
- **Made in Taiwan**

Ascot No.	Mfg. No.	Description
157-10874	A874	3" Cut-Off Tool (2-7/8" Wheel Size)

1/4" MINI ANGLE DIE GRINDER

- Compact, lightweight design for easy use
- **FREE SPEED:** 22,000 RPM
- Right angle for easy maneuvering
- **APPLICATIONS:** High speed blending, smoothing, porting and deburring in confined areas
- **Made in Taiwan**

Ascot No.	Mfg. No.	Description
157-10875	A875	1/4" Mini Angle Die Grinder

LOW SPEED TIRE BUFFER W/ OVERHOSE KIT

- Lever-style tease trigger with lock-off for easy operation and protection against accidental start-up
- Jacobs chuck
- Convenient hanger keeps tool within easy reach
- **FREE SPEED:** 3,000 RPM
- Piped-away exhaust (included) blows air away from work area and operator
- **APPLICATIONS:** Ideal for patchwork, roughing for recapping and cleaning tire moldings
- **Made in Taiwan**

Ascot No.	Mfg. No.	Free Speed (RPM)	Air Con. Avg (CFM)	Air Inlet (NPT)	Hose Size	Length	Wgt. (lb.)
157-01327	IR327-LSA	3,000	14	1/4"	3/8"	8.5"	1.13

1/2" AIR DRILL

- Quick change chuck retainer
- **FREE SPEED:** 500 RPM
- **CHUCK SIZE:** 1/2"
- Exhaust hose
- Side handle
- Swivel air inlet for ease of use
- **NET WEIGHT:** 2.86 lb.
- **Made in Taiwan**

Ascot No.	Mfg. No.	Description
157-01035	A1035	1/2" Air Drill w/ Quick Change Chuck and Exhaust Hose
175-11035	H025	Air Hose Exhaust Kit for A1035 Air Drill

AIR TOOLS & ACCESSORIES

CORDLESS LOW SPEED BUFFER KIT

- Dedicated buffing and drilling
- 2-Mode Drive Control™
- **DRILLING MODE:** 1,200 RPM
- **BUFFING MODE:** 2,500 RPM
- Runtime to complete up to 30 flat repairs on a single XC4.0Ah battery
- Premium rubber overmold withstands corrosive materials and provides increased comfort when in use
- Compatible with all M12™ batteries & chargers
- **POWERSTATE™** Brushless Motor
- **REDLINK PLUS™** Electronic Intelligence:
- **REDLITHIUM™** batteries:
- **KIT INCLUDES:** Low Speed Tire Buffer, M12™ REDLITHIUM™ CP2.0 Battery, M12™ REDLITHIUM™ XC 4.0 Extended Capacity Battery Pack, M12™ Lithium-ion Battery Charger, Quick Change Adapter, Carrying Case

158-40922
Cordless Low Speed Buffer Kit



TOP SELLER

Ascot No.	Mfg. No.	Description
158-40922	2409-22	Cordless Low Speed Buffer Kit

CORDLESS 1/4" RIGHT ANGLE DIE GRINDER

- First cordless right angle die grinder that delivers the performance and size demanded by professional service mechanics
- **POWERFUL:** Delivers 20% more power than pneumatic competition
- Features **POWERSTATE™** Brushless Motor Technology
- Provides up to .3 HP performance
- **BEST-IN-CLASS SIZE:** Fits in tight places with greater mobility and access
- **UNMATCHED CONTROL:** 4-Mode speed control and responsive variable-speed trigger
- Part of the M12™ System
- **KIT (ASCOT# 157-48522) INCLUDES:** Tool, (2) REDLITHIUM™ CP2.0 batteries, Lithium-ion Battery Charger, (2) Wrenches & Carrying Case



157-48520
Cordless 1/4" Right Angle Die Grinder (Bare Tool)

PART OF THE M12™ SYSTEM

FITS IN TIGHT PLACES

157-48522
Cordless 1/4" Right Angle Die Grinder (Kit)

Ascot No.	Mfg. No.	Description
157-48520	2485-20	Cordless 1/4" Right Angle Die Grinder (Bare Tool)
157-48522	2485-22	Cordless 1/4" Right Angle Die Grinder (Kit)



AIR TOOLS & ACCESSORIES



CORDLESS 1/2" DRIVE IMPACT WRENCH

- **4 CUSTOMIZABLE MODES:** Provides multiple fastening torque outputs designed for sedans, light trucks and box trucks
- **POWERSTATE™ BRUSHLESS MOTOR:** Delivers up to 750 ft./lb. of fastening torque and 1,100 ft./lb. of nut-busting torque
- **PART OF THE M18™ SYSTEM:** Featuring over 175+ Tools
- **LONG MOTOR LIFE:** POWERSTATE™ Brushless Motor delivers maximum power and long motor life
- **FASTER TIRE SERVICE:** Enables users to perform faster tire service by removing the hassle of pneumatic hoses, compressors, and torque sticks



153-76920
Cordless 1/2" Drive Impact Wrench - 2" Extended Anvil (Bare Tool)

153-76922
Cordless 1/2" Drive Impact Wrench - 2" Extended Anvil (Kit)

Ascot No.	Mfg. No.	Description
153-76920	2769-20	Cordless 1/2" Drive Impact Wrench - 2" Extended Anvil (Bare Tool)
153-76922	2769-22	Cordless 1/2" Drive Impact Wrench - 2" Extended Anvil (Kit)

CORDLESS 1" DRIVE IMPACT WRENCH

- **POWERSTATE™ BRUSHLESS MOTOR:** Delivers up to 1,800 ft./lb. nut-busting torque, making it the world's most powerful cordless impact wrench
- Up to 7 lb. lighter weight allowing for less user fatigue
- **ONE-KEY™ COMPATIBLE:** Ability to customize, track and manage tools for increased productivity and investment protection
- **4-MODE DRIVE CONTROL™:** Provides greater control over output speed and power
- Includes the ability to set a repeatable torque output for maximum control
- **LOWER OWNERSHIP COST:** Eliminates compressors and generators, providing greater portability and lower cost of ownership

155-86722
Cordless 1" Drive Impact - Standard Anvil (Kit)



Ascot No.	Mfg. No.	Description
155-86722	2867-22	Cordless 1" Drive Impact - Standard Anvil (Kit)





AIR TOOLS & ACCESSORIES

M12 FUEL COMMERCIAL TIRE FLAT REPAIR KIT

- Designed to deliver increased productivity for high-volume commercial flat repairs that commercial tire technicians demand
- Includes the M12 FUEL™ low-speed tire buffer, the world's first cordless tire buffer
- With the runtime to perform up to 30 flat repairs on a single XC4.0Ah battery, increasing your productivity with less downtime
- Also included is the M12 FUEL™ 1/2" Drill/Driver, the most powerful, most compact, and fastest tool in its class



158-45922



MILWAUKEE 1" DRIVE EXTENDED ANVIL D-HANDLE IMPACT WRENCH

- POWERSTATE™ Brushless Motor delivers up to 2,000 ft-lbs of nut-busting torque and 1,900 ft-lbs of fastening torque
- Install up to 200 1-1/4" bolts on a single HIGH OUTPUT™ HD12.0Ah battery
- M18™ REDLITHIUM™ Battery Packs are compatible with all M18™ tools
- The 4-Mode DRIVE CONTROL™ provides you with greater control over the output speed and power of the MILWAUKEE® High Torque Impact Wrench
- The ONE-KEY™ Technology allows you to customize, track, and manage the impact wrench with the ability to set a repeatable torque output for maximum control



155-86920



155-86922

Ascot No.	Mfg. No.	Description
158-45922	3459-22	M12 Fuel Commercial Flat Repair Kit Kit Includes: - (1) M12 FUEL™ Low Speed Tire Buffer(2409-20) - (1) M12 FUEL™ 1/2" Drill/Driver(3403-20) - (1) Quick Change Adapter - (1) M12™ REDLITHIUM™ CP2.0 Battery(48-11-2420) - (1) M12™ REDLITHIUM™ XC 4.0 Extended Capacity Battery Pack(48-11-2440) - (1) M12™ Lithium-ion Battery Charger (48-59-2401) - (1) Carrying Case I

Ascot No.	Mfg. No.	Description
155-86922	2869-22	1" Drive Extended Anvil D-Handle Impact Wrench - Kit Kit Includes: (1) M18 FUEL™ 1" D-Handle High Torque Impact Wrench w/ ONE-KEY™ (2868-20) (2) M18 REDLITHIUM™ HIGH OUTPUT™ HD12.0 Battery Pack (48-11-1812) (1) M18™ & M12™ Rapid Charger (48-59-1808) (1) Adjustable Handle (1) Lanyard Loop (1) Contractor Bag
155-86920	2869-20	1" Drive Extended Anvil D-Handle Impact Wrench - Bare Tool Only



AIR TOOLS & ACCESSORIES



172-55721
Cordless 3/8"
Ratchet Tool Set

CORDLESS 3/8" RATCHET TOOL KIT

- **MOST POWERFUL:** Delivers industry leading torque output of up to 40 ft./lb.
- **MOST DURABLE:** Worlds 1st brushless ratchet provides 2x longer motor life
- **MOST COMPACT:** Up to 20% smaller head size
- Best-in class torque to head size ratio
- Premium metal components for longer durability

Ascot No.	Mfg. No.	Description
172-55721	2557-21	Cordless 3/8" Ratchet Tool Kit



345-11835
M18 Lithium High
Output Battery

M18 LITHIUM HIGH OUTPUT BATTERY

- **REDLINK™ INTELLIGENCE:** Our battery circuitry provides optimized performance and overload protection using total system communication between tool, battery and charger
- **VERSATILITY:** Powers all 175+ M18™ cordless solutions
- **FUEL GAUGE ONBOARD:** Displays remaining run-time
- **BEST-IN-CLASS CONSTRUCTION:** Offers long-lasting performance and the best protection against jobsite, weather and environmental conditions
- *Compatible with all M18™ tools*
- 2 year battery warranty

Ascot No.	Mfg. No.	Description
345-11835	48-11-1835	M18 Lithium High Output Battery



345-11850
M18 Lithium
5.0AH Battery
Pack

M18 LITHIUM 5.0AH BATTERY PACK

- **REDLINK™ INTELLIGENCE:** Provides optimized performance and overload protection using total system communication between tool, battery and charger
- **BEST-IN-CLASS CONSTRUCTION:** Offers long-lasting performance and durability
- **VERSATILITY:** Powers more than 175+ Milwaukee® M18™ cordless power tools
- **FUEL GAUGE ONBOARD:** Displays remaining runtime for less downtime on the job
- **ALL-WEATHER PERFORMANCE:** Delivers fade free power in extreme jobsite conditions
- *Ground transport only*

Ascot No.	Mfg. No.	Description
345-11850	48-11-1850	M18 Lithium 5.0AH Battery Pack



345-11812
M18 RedLithium
High Output HD
12.0 Battery Pack

M18 REDLITHIUM HIGH OUTPUT HD 12.0 BATTERY PACK

- **Provides 50% more power and runs 50% cooler vs M18™ REDLITHIUM™ HD battery packs**
- Delivers fade free power and runs substantially cooler through heavy applications
- **Fully compatible with 150+ M18™ solutions**
- Provides increased power in extreme cold weather conditions (below 0F / -18C)

Ascot No.	Mfg. No.	Description
345-11812	48-11-1812	M18 RedLithium High Output HD 12.0 Battery Pack



AIR TOOLS & ACCESSORIES

QUICK CHUCK ADAPTER, EXTRA LONG

- Quick change extra-long adapter 3/8"-24 thread
- Two flat washers, two nuts included
- 1-3/4" (45mm) thread length
- For rasps, buffing wheels and brushes where extra length is required

Ascot No.	Mfg. No.	Description
173-00024	AS-1047XL	Quick Chuck Adapter, Extra Long



173-00024
Quick Chuck Adapter, Extra Long

QUICK CHUCK ADAPTER, LONG

- Quick change long adapter 3/8"
- One flat washer, one nut included
- 1" (25mm) thread length

Ascot No.	Mfg. No.	Description
173-00025	AS-1047	Quick Chuck Adapter, Long



173-00025
Quick Chuck Adapter, Long

DUAL HEAD QUICK CHUCK ADAPTER

- Quick change extra-long adapter 3/8"-24 thread
- Two flat washers, two adapters included
- 1-3/4" (45mm) thread length
- For rasps, buffing wheels and brushes where extra length is required

Ascot No.	Mfg. No.	Description
173-00026	AS-1046D	Dual Head Quick Chuck Adapter



173-00026
Dual Head Quick Chuck Adapter

QUICK CHANGE ADAPTER FOR 3/8" BURRS

- Quick release adapter for 3/8" shank
- For use with 10mm carbide cutters and quick release couplers
- Two allen screws to ensure tight fit
- Allen wrench included

Ascot No.	Mfg. No.	Description
173-00027	AS-1041-3/8	Quick Change Adapter For 3/8" Burrs



173-00027
Quick Change Adapter for 3/8" Burrs

MISC. IMPACT WRENCH ACCESSORIES

Ascot No.	Mfg. No.	Description
173-00018	QC18	Quick Chuck Adapter W/ Collar
173-00019	QC19	Quick Chuck Adapter W/ Spacer 1" x 3/8" Thread
173-00020	QC20	Quick Chuck Adapter for 1/8" Shank
173-00022	QC22	Quick Chuck Adapter for 1/4" Shank
173-00023	QC23	Quick Chuck Adapter for 5/16" Shank
175-82651	H-082651	1" Impact Wrench Retainer Clip O-Ring
175-83071	P-08371	O-Ring for 1/2" Impact Wrench Retainer Clips
175-94791	CA-094791	1" Impact Wrench Retainer Clip
175-52122	-	1/2" Retainer Clip



173-00018
Quick Chuck Adapter w/ Collar

173-00019
Quick Chuck Adapter w/ Spacer 1" x 3/8" Thread

173-00020
Quick Chuck Adapter for 1/8" Shank

173-00022
Quick Chuck Adapter for 1/4" Shank

173-00023
Quick Chuck Adapter for 5/16" Shank

AIR TOOL LUBRICANTS



181-00016
B'laster Air Tool Oil/Lube, 16 oz.

B'LASTER AIR TOOL OIL/LUBE

- Provides lubrication & prolongs tool life
- Improves tool performance
- Formulated for use with in-line oilers
- **QUANTITY:** 12 per case

Ascot No.	Mfg. No.	Description
181-00016	16-ATL	B'laster Air Tool Oil/Lube, 16 oz. (12 per case)



181-00404
B'laster Air Tool Conditioner, 11 oz. Aerosol

B'LASTER AIR TOOL CONDITIONER

- Cleans & restores pneumatic tools
- Protects tools from freezing down to -25°F
- Reduces friction
- **QUANTITY:** 12 per case

Ascot No.	Mfg. No.	Description
181-00404	16-ATC	B'laster Air Tool Conditioner, 11 oz. (12 per case)



181-00085
Marvel Air Tool Oil

MARVEL AIR TOOL OIL - QUART

- Specially formulated for use in all piston type and rotary air tools as well as in-line air lubricators
- Prevents rust formation while providing positive lubrication for smooth starting and longer tool life
- Assures maximum performance by dissolving gum and sludge that cut down tool speed and reduce power output
- **QUANTITY:** 6 bottles per case
- **Equivalent to Marvel MM85R**

Ascot No.	Mfg. No.	Description
181-00085	MM85R	Marvel Air Tool Oil, Quart Size (6 per case)



MARVEL AIR TOOL OIL - 4 OZ.

- 12 Bottles per case
- 4 oz. bottles
- Specifically formulated for use in all air tools or in-line lubricators
- Prevents rust
- Assures maximum tool performance
- Made in the U.S.A

Ascot No.	Mfg. No.	Description
181-00080	MM80R	Marvel Air Tool Oil



181-00080
Marvel Air Tool Oil

181-00406
Super Red Pneumatic Air Tool Oil

SUPER RED PNEUMATIC AIR TOOL LUBRICANT

- Dissolves gum & varnish formation
- Prevents gum & varnish formation
- Ensures smoother starts
- Special rust & oxidation inhibitor
- Clean and free running
- **QUANTITY:** 12 quarts per case

Ascot No.	Mfg. No.	Description
181-00406	0406	Super Red Pneumatic Air Tool Oil, Quart (12 per case)

TORQUE WRENCHES & ACCESSORIES

PRESET TORQUE WRENCHES

- One-way, not bi-directional
- ± 4% accuracy
- Cushioned ratchet heads
- Color-coded presets

4-PIECE WHEEL TORQUE WRENCH SET

- **WRENCHES INCLUDED:** Blue, Grey, White and Aqua
- **1/2" DRIVE SOCKETS INCLUDED:** 17mm, 19mm, 21mm, 3/4", 13/16", 7/8", and a 6" extension
- *Includes color-coded wall board for easy access*
- Color coded presets
- **Made in USA (Snap On)**

Ascot No.	Mfg. No.	Description
168-13000	PTWS-1	4-Wrench Preset Torque Wrench Set



168-13000
4-Wrench
Wheel Torque
Wrench Set

6-PIECE WHEEL TORQUE WRENCH SET

- **WRENCHES INCLUDED:** Yellow, Blue, Grey, White, Aqua and the adjustable torque wrench
- **1/2" DRIVE SOCKETS INCLUDED:** 17mm, 19mm, 21mm, 3/4", 13/16", 7/8", and a 6" extension
- *Includes color-coded wall board for easy access*
- **Made in USA (Snap On)**



Ascot No.	Mfg. No.	Description
168-16000	PTWS-2	6-Wrench Preset Torque Wrench Set



168-16000
6-Wrench
Wheel Torque
Wrench Set

INDIVIDUAL PRESET TORQUE WRENCHES

- One-way, not bi-directional
- ± 4% accuracy
- Cushioned ratchet heads
- Color-coded presets
- **Made in USA**

Ascot No.	Mfg. No.	Description
168-12065	65TP-3R	65 ft./lb. Preset Torque Wrench (Yellow)
168-12080	80TP-3R	80 ft./lb. Preset Torque Wrench (Blue)
168-12100	100TP-3R	100 ft./lb. Preset Torque Wrench (Grey)
168-12120	120TP-3R	120 ft./lb. Preset Torque Wrench (White)
168-12140	140TP-3R	140 ft./lb. Preset Torque Wrench (Aqua)
168-12250	2503MFRRH	250 ft./lb. Micro-Adjustable Torque Wrench
168-96509	96-500-9RK	Preset Torque Wrench Ratchet Head Repair Kit

TORQUE WRENCHES & ACCESSORIES

SPLIT BEAM TORQUE WRENCHES

- +/- 4% accuracy
- Non coil-spring mechanism, no need to return to zero after use, which results in longer tool life
- Knob-type torque adjustment for faster and energy saving efficiency
- Torque setting easily read through the window scale
- TPR cushion handle is oil resistant, the handle provides comfort and ease of control
- Loud click sound and strong impulse when required torque is reached

- **Certified & Calibrated**
- **Made in Taiwan**

Ascot No.	Mfg. No.	Description
168-00250	250-SB	1/2" Drive 250 ft./lbs. Split Beam Torque Wrench
168-00600	600-SB	3/4" Drive 600 ft./lbs. Split Beam Torque Wrench
168-00601	601-SB	1" Drive 600 ft./lbs. Split Beam Torque Wrench
168-00251	250-SB-TK	Repair Kit for 250 ft./lbs. Split Beam Torque Wrench

**COMING SOON!
FALL 2024**

168-00601
1" Drive 600 ft./lb. Split Beam Torque Wrench

168-00600
3/4" Drive 600 ft./lb. Split Beam Torque Wrench

168-00250
1/2" Drive 250 ft./lb. Split Beam Torque Wrench



168-00250
1/2" Drive 250 ft./lb. Split Beam Torque Wrench



TORQUE WRENCHES & ACCESSORIES

1/2" DRIVE TORQUE WRENCH

- Dual direction
- Locking collar prevents accidental setting adjustment
- Easy to read laser marked scale
- Blow molded case with calibration certificate
- Range: 25-250 ft./lb.
- Overall length: 25"
- **Certified & Calibrated**
- **Made in Taiwan**

168-00425
1/2" Drive Torque Wrench

Ascot No.	Mfg. No.	Description
168-00425	AS-425	1/2" Drive Torque Wrench

1/4" DRIVE TORQUE WRENCH

- Easy-to-read and set for error-free adjustments
- Automatic locking torque adjustment
- Ideal for TPMS applications
- Blow molded case
- **Range: 10-150 in./lb.**
- **Certified & Calibrated**
- **Made in Taiwan**

168-00652
1/4" Drive Torque Wrench

Ascot No.	Mfg. No.	Description
168-00652	AS-652H	1/4" Drive Torque Wrench

1/2" DRIVE MICRO-ADJUSTABLE TORQUE WRENCH

- Dual scale, Calibrated dual direction
- Positive Lock with spring loaded pull down lock ring
- Fast, accurate and easy to set
- Easy-to-read Laser marked scale
- Ergonomic comfort-grip
- Range: 50-250 ft./lb.
- Most feature Quick Release buttons which provide good socket retention as well as easy socket removal
- Accuracy: $\pm 4\%$ clockwise $\pm 6\%$ CCW of indicated value, CW, from 20% to 100% of full scale
- **Certified & Calibrated**
- **Made in Taiwan**

168-12250
1/2" Drive Micro-Adjustable Torque Wrench



Ascot No.	Mfg. No.	Description
168-12250	2503MFRRH	1/2" Drive Micro-Adjustable Torque Wrench

5-IN-1 INTERCHANGEABLE PRESET TORQUE WRENCH 1/2" DRIVE

- Single direction
- Torque preset: 80, 100, 120, 140 to 160 Ft-Lb
- Product in matte Finish
- Protective cover for the ratcheting head
- Angled head attachment
- Tolerance of torque $\pm 4\%$
- **Certified & Calibrated**
- **Made in Taiwan**
- **Similar to AME 67170**



Ascot No.	Mfg. No.	Description
168-80246	NS-51PTW	5-In 1 Interchangeable Preset Torque Wrench 1/2" Drive

168-80246 In Case



168-80246
5-In-1/2" Drive Preset Torque Wrench

TORQUE WRENCHES & ACCESSORIES



168-47502
1" Drive Preset
Torque Wrench

168-47501
1" Drive Preset
Torque Wrench

PRESET
FOR EASE
OF USE

1" DR. 475 FT/LB PRESET TORQUE WRENCH

- 24 Teeth
- Torque Accuracy is +/- 4%
- Industrial application with durability Ideal for heavy duty area.
- Can be split and packed in two parts for a smaller, easier to transport package
- Lockable Blow Molded Case
- **Certified & Calibrated**
- **Made in Taiwan**
- **Similar to Snap-On 1-475**



Ascot No.	Mfg. No.	Description
168-47502	1-4752P	1" Dr. 475 Ft/Lb Preset Torque Wrench



168-47502
In Case

1" DRIVE PRESET TORQUE WRENCH

- Preset at 475 ft./lb.
- Designed for fleet applications
- Massive 4-1/2' length for high torque applications
- Supplied with handy storage bag for sockets and extensions
- Both the wrench and the bag have reflective strips for safe highway night use
- **Certified & Calibrated**
- **Made in Taiwan**



Ascot No.	Mfg. No.	Description
168-47501	1-475	1" Drive x 475 ft./lb. Preset Torque Wrench

TORQUE WRENCHES & ACCESSORIES

FLEX HINGE STYLE TORQUE WRENCH

- Robust construction
- **ACCURATE RESULTS:** ±4%
- Adjustable torque settings
- **DUAL SCALED:** Ft./lb. and N.m.
- The large break angle improves accuracy by reducing the possibility of over torquing
- Cam control of the mechanism gives a controlled break
- Every wrench supplied with a calibration certificate
- Durable storage case
- **2 ADAPTERS INCLUDED:** 3/4" to 1", 3/4" to 3/4"
- **Certified & Calibrated**
- **Made in Taiwan**
- **Similar to Norbar 4AR**

Ascot No.	Mfg. No.	Description
168-60011	60011	600 ft./lb. Flex Hinge Style Torque Wrench
168-60012	60012	2-Piece 600 ft./lb. Flex Hinge Style Torque Wrench



168-60012
in case

TORQUE WRENCH SQUARE DRIVES

- **Made in Taiwan**

Ascot No.	Mfg. No.	Description
168-61019	12299	1" Square Drive for Flex Hinge Torque Wrench
168-60025	12297	3/4" Square Drive for Flex Hinge Torque Wrench

3/4" X 1" X 13" TORQUE WRENCH EXTENSION

- **Made in Taiwan**

Ascot No.	Mfg. No.	Description
169-13413	13413E	3/4" Dr. x 1" Dr. x 13" Impact Extension

PRESET VALVE NUT TORQUE WRENCHES

- Wrench flexes when proper torque setting is reached
- Prevents overtightening of the valve grommet
- Cushioned handle
- Sizes and preset torque settings laser etched on shaft
- +/- 4% accuracy
- **Made in Taiwan**

Ascot No.	Mfg. No.	Description
168-00058	NSPTW58	5/8" Preset Torque Wrench for TR540-550 Series Valve Hex Nuts
168-00916	NSPTW916	9/16" Preset Torque Wrench for TR570 Series Valve Hex Nuts

168-60011
600 ft./lb. Flex Hinge Style Torque Wrench



168-60012
2-Pc. 600 ft./lb. Flex Hinge Style Torque Wrench



168-61019
1" Square Drive



169-13413
Torque Wrench Extension

168-60025
3/4" Square Drive



168-00916
9/16" Preset Torque Wrench



168-00058
5/8" Preset Torque Wrench

TORQUE WRENCHES & ACCESSORIES



INCLUDES 5 TORQUE SOCKETS

168-12450
1/2" Drive 5-Piece Torque Limiting Extension Set

5-PIECE 1/2" DRIVE TORQUE LIMITING EXTENSION SET

- Set includes all 5 extension sockets listed below
- Provides the ability to torque wheel nuts on passenger cars to the correct specification
- Set comes in a durable plastic blow molded case
- *Individual extensions sold separately*
- **Made in Taiwan**

Ascot No.	Mfg. No.	Description
168-12450	2450	5-Piece 1/2" Drive Torque Limiting Extension Set

5-PIECE TORQUE LIMITING SET CONTENTS:

Ascot No.	Mfg. No.	Description
168-12410	24100	1/2" Drive 100 ft./lb. Torque Limiting Extension (Gray)
168-12412	24120	1/2" Drive 120 ft./lb. Torque Limiting Extension (White)
168-12414	24140	1/2" Drive 140 ft./lb. Torque Limiting Extension (Aqua)
168-12465	2465	1/2" Drive 65 ft./lb. Torque Limiting Extension (Yellow)
168-12480	2480	1/2" Drive 80 ft./lb. Torque Limiting Extension (Blue)

10-PIECE 1/2" DRIVE TORQUE LIMITING SOCKET SET

- Contains the most popular torque sockets to service the majority of passenger cars and light trucks
- Heavy duty blow molded case
- *Set includes all 10 torque sockets listed below*
- **LIFETIME WARRANTY**
- **Made in Taiwan**

Ascot No.	Mfg. No.	Description
168-02880	12880	10-Piece 1/2" Drive Torque Limiting Socket Set

10-PIECE TORQUE LIMITING SET CONTENTS:

Ascot No.	Mfg. No.	Description
168-21780	121780M	1/2" Drive 17mm (11/16"): 80 ft./lb. Torque Socket (Red)
168-21910	121910M	1/2" Drive 19mm (3/4"): 100 ft./lb. Torque Socket (Gray)
168-21980	121980M	1/2" Drive 19mm (3/4"): 80 ft./lb. Torque Socket (Blue)
168-22212	122212M	1/2" Drive 22mm (7/8"): 120 ft./lb. Torque Socket (White)
168-22214	122214M	1/2" Drive 22mm (7/8"): 140 ft./lb. Torque Socket (Turquoise)
168-22610	122610	1/2" Drive 21mm (13/16"): 100 ft./lb. Torque Socket (Brown)

1" DRIVE 4 PC. HEAVY DUTY TORQUE SOCKET SET

- Contents: Red - 1-1/4" x 250 ft./lb., Brown - 33mm x 475 ft./lb., Black - 1-1/2" x 475 ft./lb., Yellow - 13/16" x 475 ft./lb.
- Sockets properly torque wheel nuts to exact factory specs
- Prevents warping of rotors, which causes brake pulsation
- Eliminates broken studs and nuts
- Avoids damage to aluminum alloy wheels
- Stops customer complaints about overtightened lug nuts
- Sockets stop turning at the CORRECT torque
- Includes blow mold case
- **Made in Taiwan**



INCLUDES 10 TORQUE SOCKETS

TOP SELLER

168-02880
1/2" Drive 10-Piece Torque Limiting Socket Set

168-04994
1" Drive 4 Pc. Heavy Duty Torque Socket Set



**COMING SOON!
FALL 2024**

Ascot No.	Mfg. No.	Description
168-04994	SO4994	1" Drive 4 Pc. Heavy Duty Torque Socket Set

TORQUE WRENCHES & ACCESSORIES

1/2" DRIVE 65 FT./LBS. TORQUE EXTENSION

- Provides the ability to torque wheel nuts on passenger cars to the correct specification
- 1/2" drive
- Bright yellow in color for quick and easy identification
- 65. ft./lbs. torque
- **Made in Taiwan**

Ascot No.	Mfg. No.	Description
168-12465	TMRT11406	1/2" Drive 65 Ft./Lbs. Torque Extension

1" DRIVE 33MM TORQUE SOCKET

- Brown Torq stick
- 1" in. drive torque socket hex 33mm
- **475 ft./lbs.**
- Solid one-piece construction
- Covered by a **lifetime warranty**
- **Made in Taiwan**

Ascot No.	Mfg. No.	Description
168-01475	334031L7	1" Drive 33mm Torque Socket Hex 475ft/lb Brown

3/4 DRIVE 33MM TORQUE SOCKET

- Brown Torq stick
- 3/4 in. drive torque socket hex 33mm
- **475 ft./lbs.**
- Solid one-piece construction
- Covered by a **lifetime warranty**
- **Made in Taiwan**

Ascot No.	Mfg. No.	Description
168-00475	334030L7	3/4" Drive 33mm Torque Socket Hex 475ft/lb Brown

1" DRIVE TRUCK TORQUE EXTENSIONS

- 1" drive square ends
- Once the proper torque is reached the extension will absorb any excess torque
- **Made in Taiwan**

Ascot No.	Item	Mfg. No.	Description
495-16004	A	1600-P	1" Drive 475 ft./lb. Torque Limiting Extension
495-16005	B	1600-R	1" Drive 250 ft./lb. Torque Limiting Extension
495-16006	C	1600-S	1" Drive 350 ft./lb. Torque Limiting Extension
495-16007	D	1600-T	1" Drive 175 ft./lb. Torque Limiting Extension
495-16008	E	1600-W	1" Drive 650 ft./lb. Torque Limiting Extension
495-16009	F	1600-Y	1" Drive 550 ft./lb. Torque Limiting Extension

2024 LUG NUT TORQUE CHART

- Wall chart measuring 26-7/8" x 39"
- Provides lug nut specifications for cars and light trucks to Model Year 2023
- Laminated for durability
- For use with Original Equipment wheels
- Shipped in a protective mailing tube

Ascot No.	Mfg. No.	Description
168-02024	TC2024	2024 Lug Nut Torque Chart



168-12465
1/2" Drive 65 ft./lbs. Torque Extension



168-01475
1" Drive 33mm Torque Socket



168-00475
3/4" Drive 33mm Torque Socket

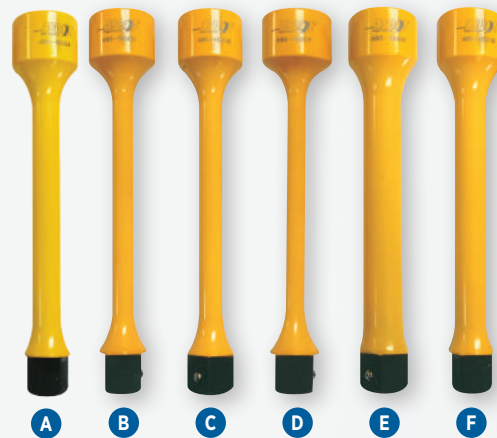

168-02024
2024 Lug Nut Torque Chart

TORQUE WRENCHES & ACCESSORIES

LUG NUTS



Ascot No.	Ascot Mfg. No.	Mfg. No.	Description	Box QTY.	Case QTY.
491-11001	LN-01	27587	LN-01 14MM x 2" Big Bulge, Ford 13/16"Hex	20	100
491-11002	LN-02	13760	LN-02 12MM x 1.50" Bulge Acorn, Accura/Honda 3/4" Hex	20	100
491-11003	LN-03	13438-09	LN-03 14MM x 1.50" Duplex Bulge Acorn, Dodge/Jeep/Ram 7/8" Hex	20	100
491-11004	LN-04	13439	LN-04 14MM x 1.50" Duplex Bulge, GM 7/8" Hex	20	100
491-11005	LN-05	13438-10	LN-05 9/16"-18 Duplex Bulge Acorn, Dodge/Jeep/Ram 7/8" Hex	20	100
491-11006	LN-06	15900-04	LN-06 1/2"-20 Bulge Acorn, 13/16" Hex	20	100
491-11007	LN-07	15900-06	LN-07 12MM x 1.25" Bulge Acorn, 13/16" Hex	20	100
491-11008	LN-08	15900-07	LN-08 12MM x 1.50" Bulge Acorn, 13/16" Hex	20	100
491-11009	LN-09	17201-06	LN-09 12MM x 1.25" Bulge Med Mag w/Washer, Nissan 13/16" Hex	20	100
491-11010	LN-10	17201-07	LN-10 12MM x 1.50" Bulge Med Mag w/Washer, Toyota 13/16" Hex	20	100
491-11011	LN-11	17244	LN-11 14MM x 1.50" Duplex Mag w/Washer, Toyota 7/8" Hex	20	100
491-11012	LN-12	17430	LN-12 12MM x 1.50" Chrysler Mag 3/4" Hex	20	100
491-11013	LN-13	15735-04	LN-13 1/2"-20 Bulge Acorn, 3/4" Hex	20	100
491-11014	LN-14	13968	LN-14 12MM x 1.50" Ford 13/16" Hex	20	100
491-11015	LN-15	15735-07	LN-15 12MM x 1.50" Bulge Acorn, 3/4" Hex	20	100
491-11016	LN-16	13735	LN-16 12MM x 1.25" Bulge Acorn, 3/4" Hex	20	100
491-11017	LN-17	93928	LN-17 12MM x 1.25" Cone Lug Bolt, 19mm Hex	20	100
491-11018	LN-18	13503	LN-18 14MM x 1.50", Ford 13/16" Hex	20	100
491-11020	LN-20	49334-09	14mm x 1.50" Short Truck 7-Spline Lug Nut	20	100
491-11021	LN-21	49034-07	12mm x 1.50" Spline 6-Sided Lug Nut	20	100
491-11022	LN-22	49034-06	12mm x 1.25" Spline 6-Sided Lug Nut	20	100
491-11023	LN-23	49034BKC-04	1/2"-20 Spline 6-Sided Lug Nut - Black	20	100
491-11024	LN-24	15735BKC-09	14mm x 1.50" Bulge Acorn 2 Pc. Lug Nut - 3/4" Hex - Black	20	100
491-11025	LN-25	15735BKC-07	12mm x 1.50" Bulge Acorn 2 Pc. Lug Nut - 3/4" Hex - Black	20	100
491-11026	LN-26	49033BKC-2PC-07	12mm x 1.50" Spline 6-Sided Lug Nut - Black	20	100
491-11027	LN-27	49033-2PC-07	12mm x 1.50" Spline 6-Sided 2-Pc. Lug Nut	20	100
491-11028	LN-28	11300-07	12mm x 1.50" Open End Bulge Acorn Lug Nut - 3/4" Hex - Zinc	20	100
491-11029	LN-29	11300-09	14mm x 1.50" Open End Bulge Acorn Lug Nut - 3/4" Hex - Zinc	20	100
491-11030	LN-30	11300-04	1/2"-20 Open End Bulge Acorn Lug Nut - 3/4" Hex - Zinc	20	100
491-11031	LN-31	11353BK-09	14mm x 1.50" Black Ford Heavy Duty Lug Nut	20	100
491-11032	SA-01	K569BKE	6-Spline Car Adapter - 3/4" & 13/16" Drive	1	144
491-11033	SA-02	K569LBKE	7-Spline Truck Adapter - 7/8" & 13/16" Drive	1	144
491-11035	LN-35	12409	12mm x 1.25" Subaru Nut 3/4" Hex	20	100
491-11036	LN-36	USDK93724	12mm x 1.25" Acorn Seat Jeep Lug Bolt - 17mm Hex	20	100
491-11038	LN-38	17207	12mm x 1.50" Toyota (Long) - 13/16" Hex	20	100
491-11039	LN-39	13735	12mm x 1.50" Bulge Acorn 3/4" Hex	20	100



BLACK FORD HEAVY DUTY LUG NUT

- Direct replacement for Ford BK3Z-1012A
- For newer Ford Transit, F-250, F-350 vehicles with 19.5" wheels
- 3/4" hex
- Washer is attached to the base of the nut
- 100 per case



Ascot No.	Mfg. No.	Description
491-11031	LN-31	14mm x 1.50" Black Ford Heavy Duty Lug Nut

TORQUE WRENCHES & ACCESSORIES

18-DRAWER METAL STORAGE CABINET

- Cabinet size: 33-3/4" (W) x 11-3/4" (D) x 10-3/4" (H)
- DRAWER SIZE: 4-7/8" (W) x 11-1/4" (D) x 2-3/4" (H)
- Modular drawer design for efficiency and organization
- Heavy-duty, welded steel construction provides strength and stability
- Drawers feature stoppers to prevent accidental pulling or spilling
- Full-width handles and easy glide runners
- Shipped fully assembled and ready to use
- Weight: 45 lbs.



719-00018

Ascot No.	Mfg. No.	Description
719-00018	18D	18-Drawer Metal Storage Cabinet

32-BIN METAL STORAGE CABINET

- Cabinet size: 33-3/4" (W) x 8-1/2" (D) x 19-1/4" (H)
- DRAWER SIZE: 4" (W) x 8-3/8" (D) x 4-1/2" (H)
- Keeps your tools and accessories organized and accessible
- Heavy-duty, welded steel construction provides strength and stability
- Hemmed bin fronts for retaining parts
- Mounting holes located in the top and bottom
- Shipped fully assembled and ready to use
- Weight: 37 lbs.



719-00032

Ascot No.	Mfg. No.	Description
719-00032	32B	32-Bin Metal Storage Cabinet

6-SPLINE CAR LUG NUT ADAPTER -19MM X 21MM HEX KEY

- Manufactured from cold forged carbon steel for durability
- Used with spline drive wheel nuts
- Easy to use
- Special black oxide coating provides exceptional appearance and corrosion resistance
- This spline tool only works for lug nuts with 6 splines/points
- Made in China



491-11034

Ascot No.	Mfg. No.	Description
491-11034	K569BKE	6-Spline Car Lug Nut Adapter 19mm x 21mm Hex Key

1/2" DRIVE 4 PC. METRIC ULTIMATE TORQUE SOCKET SET

- 17mm, 19mm, 21mm sockets & interchangeable disc included in a blow molded case
- 40% increase in removal of nuts and bolts
- Non-slip socket design
- Will remove up to 70% rounded nuts and bolts
- Use as an impact socket or with the Ultimate Torque disc for added power

**COMING SOON!
WINTER 2024**



163-00440

Ascot No.	Mfg. No.	Description
163-00440	STS4-4PC-MM	1/2" Drive 4 Pc. Metric Ultimate Torque Socket Set

IMPACT SOCKETS



163-01150

163-01151



163-01152



163-02668



163-02669



164-02110

1/2" DRIVE 13-PIECE SAE SET

- Contains the following sizes: 7/16", 1/2", 9/16", 5/8", 11/16", 3/4", 13/16", 7/8", 15/16", 1", 1-1/16", 1-1/8", 1-1/4"
- **Made in Taiwan**

Ascot No.	Mfg. No.	Description
163-01150	1150	1/2" Drive 13-Piece SAE Set

1/2" DRIVE 13-PIECE SAE DEEP SET

- Contains the following sizes: 7/16", 1/2", 9/16", 5/8", 11/16", 3/4", 13/16", 7/8", 15/16", 1", 1-1/16", 1-1/8", 1-1/4"
- **Made in Taiwan**



Ascot No.	Mfg. No.	Description
163-01151	1151D	1/2" Drive 13-Piece Deep Set

1/2" DRIVE 14-PIECE METRIC STANDARD SET

- Contains the following sizes: 10mm, 11mm, 12mm, 13mm, 14mm, 15mm, 16mm, 17mm, 18mm, 19mm, 21mm, 22mm, 26mm, 27mm
- **Made in Taiwan**

Ascot No.	Mfg. No.	Description
163-01152	1151M	1/2" Drive 14-Piece Metric Standard Set

1/2" DRIVE MASTER 39-PIECE SAE IMPACT SOCKET SET

- CR-MO alloy steel for long life
- Heavy duty blow mold case
- 19 Standard Sockets: 3/8", 7/16", 1/2", 9/16", 5/8", 11/16", 3/4", 13/16", 7/8", 15/16", 1", 1-1/16", 1-1/8", 1-3/16", 1-3/8", 1-1/4", 1-5/16", 1-3/8", 1-7/16" and 1-1/2" Universal
- 19 Deep Sockets: 3/8", 7/16", 1/2", 9/16", 5/8", 11/16", 3/4", 13/16", 7/8", 15/16", 1", 1-1/16", 1-1/8", 1-3/16", 1-1/4", 1-5/16", 1-3/8", 1-7/16" and 1-1/2" Universal
- **Made in Taiwan**

Ascot No.	Mfg. No.	Description
163-02668	2668	1/2" Drive Master 39-Piece SAE Impact Socket Set

1/2" DRIVE MASTER 39-PIECE METRIC IMPACT SOCKET SET

- CR-MO alloy steel for long life
- Heavy duty blow mold case
- 19 Standard Sockets: 9mm, 10mm, 11mm, 12mm, 13mm, 14mm, 15mm, 16mm, 17mm, 18mm, 19mm, 20mm, 21mm, 22mm, 23mm, 24mm, 26mm, 27mm and 30mm
- 19 Deep Sockets: 9mm, 10mm, 11mm, 12mm, 13mm, 14mm, 15mm, 16mm, 17mm, 18mm, 19mm, 20mm, 21mm, 22mm, 23mm, 24mm, 26mm, 27mm and 30mm Universal Joint
- **Made in Taiwan**

Ascot No.	Mfg. No.	Description
163-02669	2669	1/2" Drive Master 39-Piece Metric Impact Socket Set

3/4" DRIVE 10-PIECE TRUCK SET

- Contains the following sizes: 13/16" Square Socket, 1-1/16", 1-1/8", 1-1/4" Thin Wall Deep Sockets, 1-1/2" Budd Wheel Socket, 17mm & 21mm Square Socket, 33mm, 35mm & 41mm Deep Sockets
- **Made in Taiwan**

Ascot No.	Mfg. No.	Description
164-02110	2110	3/4" Drive 10-Piece Truck Set

IMPACT SOCKETS

1/2" DRIVE 14-PIECE METRIC DEEP SET

- Contains the following sizes: 10mm, 11mm, 12mm, 13mm, 14mm, 15mm, 16mm, 17mm, 18mm, 19mm, 21mm, 22mm, 26mm, 27mm
- **Made in Taiwan**

Ascot No.	Mfg. No.	Description
163-01153	1153MD	1/2" Drive 14-Piece Metric Deep Set



163-01153



1/2" DRIVE 29-PIECE METRIC & SAE 6 POINT DEEP IMPACT SOCKET SET

- Contains the following sizes: 7/16", 1/2", 9/16", 5/8", 11/16", 3/4", 13/16", 7/8", 15/16", 1", 1-1/16", 1-1/8" and 1-1/4" deep sockets
- 17, 18, 19, 21, 22, 26 and 27mm deep sockets
- 3/4" x 13/16" deep and 19mm x 21mm deep flip sockets
- **Made in Taiwan**

Ascot No.	Mfg. No.	Description
163-05153	1153DD	1/2" Drive 29-Piece Metric & SAE 6 Point Deep Impact Socket Set



163-22219



163-05153

1/2" DRIVE 4-PIECE FLANK BITE DAMAGED NUT REMOVER SOCKET SET

- New Flank Bite design works on up to an industry leading 90% rounded lug nut
- Also safe for forward tightening of lug nuts without damage
- Contains the following sizes: 17mm, 19mm, 21mm, 22mm
- Individual sockets also available separately: 17mm (163-22017), 19mm (163-22019), 21mm (163-22021), 22mm (163-22022)
- **Made in Taiwan**

Ascot No.	Mfg. No.	Description
163-22219	122019K2	1/2" Drive 4-Piece Flank Bite Damaged Nut Remover Socket Set



164-02181

3/4" DRIVE 8-PIECE SAE DEEP SET

- Contains the following sizes: 1", 1-1/16", 1-1/8", 1-1/4", 1-5/16", 1-3/8", 1-7/16", 1-1/2"
- **Made in Taiwan**

Ascot No.	Mfg. No.	Description
164-02181	2181D	3/4" Drive 8-Piece SAE Deep Set



165-03110

1" DRIVE 10-PIECE TRUCK SET

- Contains the following sizes: 13/16" square, 1-1/16", 1-1/8", 1-1/4" thin wall deep, 1-1/2" deep with inside lip, 17mm & 21mm square with inside lip, 33mm, 35mm & 41mm deep
- **Made in Taiwan**

Ascot No.	Mfg. No.	Description
165-03110	3110	1" Drive 10-Piece Truck Set



IMPACT SOCKETS

165-03119



1" DRIVE 9-PIECE LARGE TRUCK SOCKET SET

- Contains the following sizes: 13/16" & 15/16" square, 33mm, 1-1/2", 1-5/8", 1-3/4", 1-7/8", 2" & 2-1/2" deep sockets
- **Made in Taiwan**

Ascot No.	Mfg. No.	Description
165-03119	3119	1" Drive 9-Piece Large Truck Socket Set

165-03190



1" DRIVE 9-PIECE SAE TRUCK SET

- Contains the following sizes: 13/16", 4 points budd wheel standard length, 7/8", 15/16", 1", 1-3/16", 1-1/2" deep with inside lip, 1-1/16", 1-1/8", 1-1/4" thin wall deep
- **Made in Taiwan**

Ascot No.	Mfg. No.	Description
165-03190	3190	1" Drive 9-Piece SAE Truck Set

166-04191



#5 SPLINE DRIVE 9-PIECE SAE TRUCK SET

- Contains the following sizes: 13/16", 4 points budd wheel standard length, 7/8", 15/16", 1", 1-3/16", 1-1/2" deep with inside lip, 1-1/16", 1-1/8", 1-1/4" thin wall deep
- **Made in Taiwan**

Ascot No.	Mfg. No.	Description
166-04191	4191	#5 Spline Drive 9-Piece SAE Truck Set

167-12050



1/2" DRIVE 5-PIECE DEEP THIN WALL FLIP SET

- Contains the following sizes: 3/4" x 13/16", 19mm x 21mm, 7/8" x 15/16", 17mm x 19mm, 3" extension
- **Made in Taiwan**

Ascot No.	Mfg. No.	Description
167-12050	1205D	1/2" Drive 5-Piece Deep Thin Wall Flip Set

169-01234



4-PIECE IMPACT ADAPTER SET

- CR-MO steel for long life
- Heavy duty blow molded case
- Contains the following: 1/2" (F) x 3/4" (M) adapter,
- **Made in Taiwan**

Ascot No.	Mfg. No.	Description
169-01234	1234A	4-Piece Impact Adapter Socket Set

IMPACT SOCKETS

16-PIECE LOCKING LUG KEY SET

- Heat treated chrome vanadium steel construction
- Easily removes locking lug nuts
- Thin wall sockets prevent damage to wheels
- Extra long lug keys keep your wrench away from the wheel preventing nicks and scratches
- Double hex head design fits most lug wrenches
- Packed in blow molded case with color sleeve
- **Made in Taiwan**



Ascot No.	Mfg. No.	Description
402-01283	CHT1283	16-Piece Locking Lug Key Set

1" DRIVE 7-PIECE METRIC TRUCK SET

- Contains the following Sizes: 17mm, 21mm, 4 pts. budd wheel standard length, 27mm, 33mm, 36mm, 41 mm deep
- **Made in Taiwan**

Ascot No.	Mfg. No.	Description
165-03197	3197M	1" Drive 7-Piece Metric Truck Set

1/2" DRIVE 5-PIECE 1/2 SIZE FLIP SOCKET SET

- Made from durable chromoly steel
- Coated with a rust and corrosion resistant black oxide finish
- Contains the following sizes: 18.5mm x 19.5mm, 21mm x 21.5mm, 21.5mm x 22.5mm, 22mm x 22.5mm, Extractor punch
- Individual sockets also available seperately
- **Made in Taiwan**

Ascot No.	Mfg. No.	Description
167-12051	000524	1/2" Drive 5-Piece 1/2 Size Flip Socket Set

5-PIECE 1/2" DRIVE TWIST SOCKET SET

- Designed to easily remove damaged, rounded nuts
- Use with 1/2" drive impact wrench or breaker bar
- CR-MO steel for long life
- Heavy duty blow molded case
- Includes: 17mm, 19mm, 21mm & 22mm twist sockets plus a 50mm extractor punch
- **Made in Taiwan**



Ascot No.	Mfg. No.	Description
492-00502	TSS5	5-Piece 1/2" Drive Twist Socket Set

TESLA WHEEL BOLT LOCK SOCKET SET

- Applicable for installing and removing locks of Tesla series.
- Contents: #76, #77, #78, #79, #80, #81, #82, #83, #84, #85
- This tool enables you to permit servicing of customer vehicles, even customer has lost the key.
- Hand Tool use only, don't use impact wrench and air tool
- **Made in Taiwan**

Ascot No.	Mfg. No.	Description
402-02312	10202312	Tesla Wheel Bolt Lock Socket Set



402-01283



165-03197



167-12051



492-00502



402-02312

IMPACT SOCKETS

INDIVIDUAL IMPACT SOCKETS

- CR-MO alloy steel for long life
- Radius corner design assists socket in grabbing the flat side of the fastener
- Standard and deep lengths available
- **Made in Taiwan**

1/2" DR STANDARD IMPACT SOCKETS	Ascot No.	Mfg. No.	Description
	METRIC		
	163-10170	1017M	1/2" Drive x 17mm Std.
	163-10190	1019M	1/2" Drive x 19mm Std.
	163-10210	1021M	1/2" Drive x 21mm Std.
SAE			
163-10280	1028	1/2" Drive x 7/8" Std.	

1/2" DR DEEP IMPACT SOCKETS	Ascot No.	Mfg. No.	Description
	METRIC		
	163-10143	1014MD	1/2" Drive x 14mm Deep
	163-10171	1017MD	1/2" Drive x 17mm Deep
	163-01018	1018MD	1/2" Drive x 18mm Deep
	163-01019	1019MD	1/2" Drive x 19mm Deep
	163-01021	1021MD	1/2" Drive x 21mm Deep
	163-10222	1022MD	1/2" Drive x 22mm Deep
	163-10271	1027MD	1/2" Drive x 27mm Deep
	163-01032	1032MD	1/2" Drive x 32mm Deep
	163-01033	1033MD	1/2" Drive x 33mm Deep
	SAE		
	163-01022	1022D	1/2" Drive x 11/16" Deep
	163-01024	1024D	1/2" Drive x 3/4" Deep
	163-01026	1026D	1/2" Drive x 13/16" Deep
163-10281	1028D	1/2" Drive x 7/8" Deep	
163-10300	1030D	1/2" Drive x 15/16" Deep	
163-11032	1032D	1/2" Drive x 1" Deep	
163-01034	1034D	1/2" Drive x 1-1/16" Deep	
163-01036	1036D	1/2" Drive x 1-1/8" Deep	
163-10401	1040D	1/2" Drive x 1-1/4" Deep	
163-01048	1048D	1/2" Drive x 1-1/2" Deep	
163-15260	1526SD	1/2" Drive x 13/16" Square 8-Point	

1/2" DR EXTRA THIN WALL IMPACT SOCKETS	Ascot No.	Mfg. No.	Description
	METRIC		
	163-10172	1017MEDT	1/2" Drive x 17mm Extra Thin Wall
	163-10174	1017MEDTM	1/2" Drive x 17mm Extra Thin Wall Mercedes
	163-10183	1018MEDT	1/2" Drive x 18mm Extra Thin Wall
	163-10191	1019MEDT	1/2" Drive x 19mm Extra Thin Wall
	163-10211	1021MEDT	1/2" Drive x 21mm Extra Thin Wall
	163-10223	1022MEDT	1/2" Drive x 22mm Extra Thin Wall
	SAE		
	163-10241	1024EDT	1/2" Drive x 3/4" Extra Thin Wall
163-10282	1028EDT	1/2" Drive x 7/8" Extra Thin Wall	

1/2" DR FLIP IMPACT SOCKETS	Ascot No.	Mfg. No.	Description
	METRIC		
	167-12110	1211D	1/2" Dr. x 11mm x 12mm Chrome Deep Flip
	167-12179	1271DT	1/2" Dr. x 17mm x 19mm Deep Thin Flip
	167-12910	1291	1/2" Dr. x 19mm x 21mm Std. Flip
	167-12911	1291D	1/2" Dr. x 19mm x 21mm Deep Flip
	167-12912	1291DT	1/2" Dr. x 19mm x 21mm Deep Extra Thin Flip
	167-18195	1A7535	1/2" Dr. x 18.5mm x 19.5mm Deep Flip
	167-21215	1A7538	1/2" Dr/ x 21mm x 21.5mm Deep Flip
	167-21225	1A7542	1/2" Dr. x 21.5mm x 22.5mm Deep Flip
	167-22225	1A7540	1/2" Dr. x 22mm x 22.5mm Deep Flip
	SAE		
	167-12460	1246D	1/2" Dr. x 3/4" x 13/16" Deep Flip
	167-12461	1246DT	1/2" Dr. x 3/4" x 13/16" Deep Extra Thin Flip
	167-12490	1249D	1/2" Dr. x 7/8" x 15/16" Deep Flip

3/4" DR IMPACT SOCKETS	Ascot No.	Mfg. No.	Description
	METRIC		
	164-20301	2030M	3/4" Drive x 30mm Std.
	164-02033	2033MD	3/4" Drive x 33mm Deep
	SAE		
	164-02038	2038D	3/4" Drive x 1-3/16" Deep
	164-02024	2024D	3/4" Drive x 3/4" Deep
164-02026	2026S	3/4" Drive x 13/16" Square	

IMPACT SOCKETS

Ascot No.	Mfg. No.	Description
SAE		
165-03026	3026S	1" Drive x 13/16" Square
165-03030	3030S	1" Drive x 15/16" Square
165-03042	3042D	1" Drive x 1-5/16" Deep
165-03046	3046D	1" Drive x 1-7/16" Deep
165-03052	3052D	1" Drive x 1-5/8" Deep
165-03056	3056D	1" Drive x 1-3/4" Deep
165-03060	3060D	1" Drive x 1-7/8" Deep
165-03323	3323C	1" Drive 1-1/2" Hex x 13/16" Square
165-30361	3036D	1" Drive x 1-1/8" Deep
165-30380	3038D	1" Drive x 1-3/16" Deep
165-30401	3040D	1" Drive x 1-1/4" Deep
165-30402	3040DT	1" Drive x 1-1/4" Deep Thin Wall
165-30420	3042DT	1" Drive x 1-5/16" Deep Thin Wall
165-30481	3048D	1" Drive x 1-1/2" Deep w/ Inside Lip
165-30482	3048DR	1" Drive x 1-1/2" Deep - Standard

1" DR SAE IMPACT SOCKETS

Ascot No.	Mfg. No.	Description
169-01003	1003E	1/2" Drive x 3" Extension
169-01005	1005E	1/2" Drive x 5" Extension
169-01020	1020A	1/2" Drive Female x 3/4" Male Adapt.
169-02006	2006E	3/4" Drive x 6" Extension
169-02010	2010A	3/4" Drive Female x 1/2" Male Adapt.
169-02030	2030A	3/4" Drive Female x 1" Male Adapt.
169-20100	2010E	3/4" Drive x 10" Extension
169-02013	2013E	3/4" Drive x 13" Extension
169-03006	3006E	1" Drive x 6" Extension
169-03010	3010E	1" Drive x 10" Extension
169-03013	3013E	1" Drive x 13" Extension
169-03020	3020A	1" Drive Female x 3/4" Male Adapt.
169-01002	1002E	1/4" Drive x 2" Chrome Extension

IMPACT EXTENSIONS & ADAPTERS

Ascot No.	Mfg. No.	Description
METRIC		
165-03021	3021MS	1" Drive x 21mm Square
165-30302	3030MD	1" Drive x 30mm Deep
165-03033	3033MD	1" Drive x 33mm Deep
165-03035	3035MD	1" Drive x 35mm Deep
165-30381	3038MD	1" Drive x 38mm Deep
165-30410	3041MDT	1" Drive x 41mm Deep Thin Wall
165-03041	3041MD	1" Drive x 41mm Deep
165-03321	3321MC	1" Drive 41mm x 21mm Square

1" DR METRIC IMPACT SOCKETS

Ascot No.	Mfg. No.	Description
METRIC		
166-04033	4033MD	#5 Spline x 33mm Deep
SAE		
166-04026	4026S	#5 Spline x 13/16" Square
166-04323	4323C	#5 Spline x 13/16" Square x 1-1/2" Hex

#5 SPLINE DR IMPACT SOCKETS

3/4" DRIVE X 35MM X 17MM METRIC COMBINATION SOCKET

- Removes and installs Budd-type wheel fasteners
- Two openings eliminate the need for two separate sockets
- CR-MO alloy steel for long life
- Fully guaranteed
- **Made in Taiwan**



Ascot No.	Mfg. No.	Description
164-02235	2235MC	3/4" Drive x 35mm x 17mm Metric Combination Socket

3/4" DRIVE X 41MM X 21MM METRIC COMBINATION SOCKET

- Removes and installs Budd-type wheel fasteners
- Two openings eliminate the need for two separate sockets
- CR-MO alloy steel for long life
- Fully guaranteed
- **Made in Taiwan**



Ascot No.	Mfg. No.	Description
164-02241	2241MC	3/4" Drive x 41mm x 21mm Metric Combination Socket

WHEEL & RIM PARTS



491-00133
Metric 2-Piece Hub Centering Nut

METRIC 2-PIECE HUB CENTERING NUT

- Metric 2-piece hub centering nut: 33mm hex x 1.5mm thread
- Designed to eliminate imbalance in truck wheels
- Stamped 450-500 ft./lb.
- Elongated neck for centering the wheel to the hub
- **QUANTITY:** Packaged 50 per master carton
- **MADE IN THE USA**

Ascot No.	Mfg. No.	Description
491-00133	N/A	Metric 2-Piece Hub Centering Nut



491-01133
33mm Skirt Nut

33MM SKIRT NUT

- Original Skirt Nut
- *Replaces standard M22 flange nuts on 11.25" hub-piloted wheels*
- Partially penetrates the stud hole and prevents clocking and vibration
- **QUANTITY:** 100 per case

Extended threading allowing Skirt Nut to go down into Hub-Piloted Disc Wheel an extra 3/16" (5mm) into stud hole

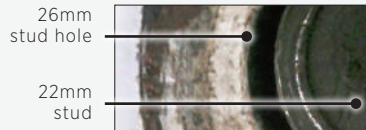
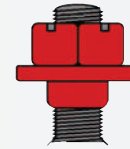

There is a fairly large tolerance between the diameter of each stud hole and the diameter of the stud itself.

Ascot No.	Mfg. No.	Description
491-01133	SN-M22	33mm Skirt Nut



491-11133
33mm Skirted Nut



33MM SKIRTED NUT

- Replaces standard M22 flange nuts on 11.25" hub-piloted wheels
- 22mm x 1.5 thread
- Partially penetrates the stud hole and prevents clocking and vibration
- **QUANTITY:** 100 per case
- **Made in China**

Ascot No.	Mfg. No.	Description
491-11133	SN33B35.1	33mm Skirted Nut

HALTEC WHEEL ATTACHING HARDWARE

- Stops wheel/hub vibrations and many tire wearing problems
- Stops wheel movement (clocking) on the face of the hub
- Eliminates wasted fuel caused by rolling resistance or "drag"
- Special graphite coating prevents nut from rusting onto the hub
- **QUANTITY:** 25 per box

Ascot No.	Mfg. No.	Description
491-02301	GL-2301	Haltec 33mm 2-Piece Flange Nut • Inner Thread M22-1.5 • For Uni-Mount 10-Hole Systems
491-02906	GL-2906	Haltec 6mm Sleeve Nut • Steel Steers
491-02919	GL-2919	Haltec 19mm Sleeve Nut • Aluminum Steers • Steel/Steel Drives • Steel Outer/Aluminum Inner Drives
491-02928	GL-2928	Haltec 28mm Sleeve Nut • HD Aluminum • Super Single • Wide Base • Aluminum Outer/Steel Inner Drives
491-02939	GL-2939	Haltec 39mm Sleeve Nut • Dual Aluminum Drive Axle



491-02301
33mm 2-Piece Flange Nut



491-02928
28mm Sleeve



491-02906
6mm Sleeve



491-02939
39mm Sleeve



491-02919
19mm Sleeve

WHEEL & RIM PARTS

10 PC. WHEEL STUD ALIGNMENT SET

- **CONTAINS (2) OF EACH OF THE FOLLOWING SIZES:** M12 x 1.25, M12 x 1.5, M12 x 1.75, M14 x 1.25, M14 x 1.5
- Each stud is marked with the thread size
- Color coded
- Knurled edges provide secure grip
- Sturdy blow molded case
- **Made in Taiwan**

Ascot No.	Mfg. No.	Description
491-19010	OT-190F	10-Piece Wheel Stud Alignment Set



491-19010
10 Pc. Wheel Stud Alignment Set



COUNTERACT WHEEL CENTERING SLEEVES

- Patent pending wheel centering system works with your OEM style two-piece flange nuts
- Self-sizing & non-corrosive design made to take-up the gap between the 22mm stud and the 26mm wheel opening, re-aligning the wheel to the TRUE CENTER of the hub bearing
- **BENEFITS INCLUDE:** increased fuel mileage, increased tire life, decreased tire vibration, stops irregular tire wear, decreased tire maintenance, reduced tire cupping, reduced "wheel off" conditions
- Designed to ensure your wheel is centered on wheel assembly
- Made from a high temperature resistant polyamide

Ascot No.	Mfg. No.	Description
491-02006	WCS-B	Counteract Wheel Centering Sleeves (Pack of 6)
491-02100	WCS-C	Counteract Wheel Centering Sleeves (Bucket of 100)
491-02101	WCS-D	Counteract Wheel Centering Sleeves (Bucket of 1000 w/ Installation Tool)

491-02006
Counteract Wheel Centering Sleeves (Pack of 6)



491-02100
Counteract Wheel Centering Sleeves (Bucket of 100)

491-02101
Counteract Installation/Removal Tool

COUNTERACT INSTALLATION/REMOVAL TOOL

- Specifically designed to install and remove Counteract Centering Sleeves

Ascot No.	Mfg. No.	Description
491-02111	WCS-IT	Counteract Installation/Removal Tool

NUT BUDDY LUG NUT REMOVER

- Loosens stubborn wheel nuts
- Use on commercial or agricultural wheels
- **GEAR RATIO:** 58:1
- **RATED OUTPUT TORQUE:** 2950 ft/lb.
- **TWO SOCKETS INCLUDED:** 1-1/2" (38mm) and 1-5/16" (33mm)

Ascot No.	Mfg. No.	Description
404-67300	67300	Nut Buddy Lug Nut Remover

404-67300
Nut Buddy Lug Nut Remover



319-00012
12-Pc. Tap & Die Set



12 PC. TAP AND DIE SET FOR WHEEL STUDS AND WHEEL NUTS

- Re-cutting and cleaning the threads is very simple
- Set includes all essential tools and adapters and comes in a blow mold case
- 4PC. DIE: m12x1.25, m12x1.5, m14x1.25, m14x1.5
- 4PC. TAP: m12x1.25, m12x1.5, m14x1.25, m14x1.5
- 1PC. tap holder (M12-M18)
- 1PC. die socket (Ø38 HEX, Ø36.5 ROUND)
- 1PC. screw pitch gauge
- 1PC. 1/2" sr. 25mm with C-ring socket
- **Made in Taiwan**

Ascot No.	Mfg. No.	Description
319-00012	TD12	12-Pc Tap & Die Set for Wheel Studs & Nuts

WHEEL & RIM PARTS



493-91420
Wheel Stud Service Kit



Video



492-10158

492-10134

492-15000

WHEEL STUD SERVICE KIT

- Works on most hubs for installation and removal.
- All sizes of studs.
- Installation done by pushing on the head, eliminating the need for threaded adapters.
- Reduces number of adapters required
- Reduces damage to studs
- Increases ease of use
- Remove and install 10 studs in only 10-15 minutes (compare to 20-30 minutes for more expensive competitive products).
- Can be powered with an impact wrench, no hydraulic power source required.
- No need to remove hub from vehicle.
- Reduces risk of damage to hubs, studs, and bearings when using tool.
- Weighs only 12 lbs., assembled to remove studs and 14 lbs., assembled to install studs.
- **Made in Taiwan**
- **Similar to OTC 4295**

Ascot No.	Mfg. No.	Description
493-91420	NS-9142	Wheel Stud Service Kit

STUD INSTALLERS AND REMOVERS

Ascot No.	Mfg. No.	Description
492-10134	X10-SI34Z	3/4" - 10 Stud Installer
492-10158	X10-SI58Z	5/8" - 11 Stud Installer
492-10180	X10-SR18B	1-1/8" (13/16") Stud Remover
492-10340	X10-SR34B	3/4" Stud Remover
492-15000	X10-NR15B	1-1/2" Hex Nut Remover Kit - 3-Piece Kit

WHEEL STUD INSTALLERS

- **Prevents damage to your lug nuts or new stud by reducing friction during stud installation**
- **Two sizes available:** Vehicle Wheel Stud Installer & Truck Wheel Stud Installer
- Works with hubs, rotors, axles
- **Made in Taiwan**
- **Similar to Lisle 28950 & 22800**



492-02278

Truck Wheel Stud Installer

492-14916

Passenger Wheel Stud Installer

Ascot No.	Mfg. No.	Description
492-02278	TWS-22	Truck Wheel Stud Installer - Fits studs up to 7/8" (22mm)
492-14916	TWS-14	Vehicle Wheel Stud Installer - Fits studs up to 9/16" (14mm)

REPLACEMENT RIB NUTS

Ascot No.	Mfg. No.	Description
499-10180	X10-LN18B	1-1/8" (13/16") Rib Nut
499-10341	X10-LN34B	3/4" Rib Nut



HEAVY DUTY DRIVE-ON RIB-GRIP LUG-OFF KITS

Ascot No.	Mfg. No.	Description
499-10200	X10-LT20B	For Removing Damaged Inner Cap Nuts (1-1/8" Diam., 13/16" Square Head). Consists of 1 Drive-On Tool And 1 Rib Nut
499-10340	X10-LT34B	For Removing Damaged 3/4" Lug Studs. Consists of 1 Drive-On Tool And 1 Rib Nut
499-10660	X10-LT66B	Triple Duty Tool For Removing Damaged Budd Wheel Inner Cap Nuts, 3/4" And 5/8" Lug Studs. Consists of 1 Drive-On Tool And 3 Rib Nuts

ASCOT

PROFESSIONAL SERVICE JACKS

3-1/2-TON FLOOR JACK

- Low profile
- Double pump design for quick lifting and improved efficiency
- Heavy steel construction for maximum durability
- **Equipped with a foot pedal to allow for hands free positioning**



302-05605
3-1/2-Ton Floor Jack



302-05614
4-Ton Floor Jack



4-TON FLOOR JACK

- Low profile
- Double pump design for quick lifting and improved efficiency
- Heavy steel construction for maximum durability
- **Equipped with a foot pedal to allow for hands free positioning**

Ascot No.	Mfg. No.	Description	Min. Hgt.	Max Hgt.	Hyd. Lift Range	Exten. Screw	Chassis Size/Ht.	Saddle Size	Handle Length	Ship Wt. (Lbs)
302-05605	AS5605	Ascot 3-1/2-Ton Floor Jack	3-3/4"	20-1/2"	16-3/4"	N/A	27.2" x 14.25"	4-1/4"	47-7/8"	100
302-05614	AS5614	Ascot 4-Ton Floor Jack	4-3/8"	20-1/4"	16"	N/A	27.7" x 14.4"	4-1/4"	47-7/8"	102.5

ASCOT LIFTING EQUIPMENT

LOW PROFILE FLOOR JACKS

- Low profile
- Double pump design for quick lifting and improved efficiency
- Heavy steel construction for maximum durability
- **Equipped with a foot pedal to allow for hands free positioning**

ASCOT
PROFESSIONAL SERVICE JACKS



Ascot No.	Mfg. No.	Description	Min. Hgt.	Max Hgt.	Hyd. Lift Range	Exten. Screw	Chassis Size/Ht.	Saddle Size	Handle Length	Ship Wt. (Lbs)
302-05601	AS5601	Ascot 2-Ton Low Profile Floor Jack	2-3/4"	24"	21-1/4"	N/A	31.9" x 14"	3-7/8"	47-7/8"	102.3
302-05602	AS5602	Ascot 2-1/2-Ton Low Profile Floor Jack	3-1/8"	19-3/4"	16-5/8"	N/A	26.3" x 13.5"	4-3/8"	47-7/8"	73.7
302-05613	AS5613	Ascot 3-Ton Floor Jack	3-3/8"	24-1/4"	20-7/8"	N/A	31.4" x 14.4"	3-7/8"	47-7/8"	105.4

LOW PROFILE FLOOR JACK REPLACEMENT PARTS

Ascot No.	Mfg. No.	Description	Applicable Models
302-60129	AS5601-29-a-FH	Spring	2-Ton/3-Ton/4-Ton
302-61301	AS5613-01	Fixed Wheel Assy.	3-Ton
302-61401	AS5614-01	Seal Kit for Pump	3-Ton/4-Ton
302-61402	AS5614-02	Fixed Wheel Assy.	4-Ton
302-61403	AS5614-03	Pump	3-Ton/4-Ton
302-61404	AS5614-04	Caster	4-Ton



www.ascotsupply.com

⚠️ WARNING: For more information go to www.P65Warnings.ca.gov.

ASCOT LIFTING EQUIPMENT

ASCOT

PROFESSIONAL BOTTLE JACKS

20-TON AIR/HYDRAULIC BOTTLE JACK

- Thick jack base provides exceptional support and stability in severe conditions
- Quick-connect feature on air valve allows easy disconnect and connection of air hose & more compact storage

SPECIFICATIONS

Ascot No.	Mfg. No.	Description
301-20220	AS2022	20-Ton Air/Hydraulic Bottle Jack

Min. Hgt.	Max Hgt.	Hyd. Lift Range	Exten. Screw	Chassis Size/Ht.	Saddle Size	Handle Length	Ship Wt. (Lbs)
10-1/8"	19-7/8"	6-1/2"	3-1/8"	N/A	N/A	9-3/8"	35.1



301-20220
20-Ton Air/Hydraulic Bottle Jack

20-TON SHORT AIR/HYDRAULIC BOTTLE JACK

- Thick jack base provides exceptional support and stability in severe conditions
- Quick-connect feature on air valve allows easy disconnect and connection of air hose & more compact storage

SPECIFICATIONS

Ascot No.	Mfg. No.	Description
301-20221	AS2022S	20-Ton Short Air/Hydraulic Bottle Jack

Min. Hgt.	Max Hgt.	Hyd. Lift Range	Exten. Screw	Chassis Size/Ht.	Saddle Size	Handle Length	Ship Wt. (Lbs)
7"	12-5/8"	3-3/8"	2-3/9"	N/A	N/A	9-3/8"	30.6



301-20221
20-Ton Short Air/Hydraulic Bottle Jack



301-20222
Release Valve

301-20224
Oil Fill Plug

301-20226
Oil Valve

301-20229
Air Motor



301-20228
Limit Ring Assy.



301-20225
Pump Core Assy.



301-20227
Seal Kit for Piston Rod

20-TON BOTTLE JACK REPLACEMENT PARTS

Ascot No.	Mfg. No.	Description	Applicable Models
301-20222	AS2002-02	Release Valve	20-Ton/20-Ton Short
301-20224	AS2022-04	Oil Fill Plug	20-Ton/20-Ton Short
301-20225	AS2022-05	Pump Core Assy.	20-Ton/20-Ton Short
301-20226	AS2022-06	Oil Valve	20-Ton/20-Ton Short
301-20227	AS2022-07	Seal Kit for Piston Rod	20-Ton/20-Ton Short
301-20228	AS2022-08	Limit Ring Assy.	20-Ton/20-Ton Short
301-20229	AS2022-09	Air Motor	20-Ton/20-Ton Short
301-20255	AS2022-10	Air Hose Assy.	20-Ton/20-Ton Short

ASCOT LIFTING EQUIPMENT



PROFESSIONAL SERVICE JACKS

22-TON JACK STANDS

- Sturdy, welded steel construction for exceptional safety and strength
- Heavy gauge steel helps prevent distortion or twisting
- Multi-position column bar for convenient height adjustment
- **Sold in pairs of two**
- **NOW FEATURING A DOUBLE LOCK SAFETY PIN FOR ADDED SECURITY**



302-05622
22-Ton Jack Stands



Ascot No.	Mfg. No.	Description
302-05622	3190	22-Ton Jack Stands

22-TON AIR/HYDRAULIC TRUCK JACK

- Large air motor provides an exceptional quick lifting experience
- Narrow chassis fits between tandem truck wheels
- Comes with three adapters in different sizes that cater to different working requirements



302-19150
22-Ton Air/Hydraulic Truck Jack

Ascot No.	Mfg. No.	Description
302-19150	AS1915	22-Ton Air/Hydraulic Truck Jack

Min. Hgt.	Max Hgt.	Hyd. Lift Range	Exten. Screw	Chassis Size/Ht.	Saddle Size	Handle Length	Ship Wt. (Lbs)
10-1/2"	21-1/8"	6-1/8"	4-1/2"	N/A	N/A	45-1/4"	101.9

22-TON AIR/HYDRAULIC TRUCK JACK REPLACEMENT PARTS

Ascot No.	Mfg. No.	Description	Applicable Models
302-20147	2014-07	Air Motor	22-Ton Truck Jack
302-19156	1915-06	Replacement Handle	22-Ton Truck Jack
302-91503	1915-03	Seal Kit	22-Ton Truck Jack
302-91504	1915-04	Limit Ring Assy.	22-Ton Truck Jack
302-91505	1915-05	Release Valve	22-Ton Truck Jack
301-20255	2022-05	Air Hose Assy.	22-Ton Truck Jack



www.ascotsupply.com

⚠️WARNING: For more information go to www.P65Warnings.ca.gov.

ASCOT

PROFESSIONAL JACKS

1500 LB. HIGH REACH JACK STAND W/ FOOT PEDAL

- Capacity: 1500 LB
- Underhoist stand is perfect for use with 2 or 4-post lifts, prevents tipping or rocking of the vehicle
- Heavy gauge steel frame prevents distortion or twisting
- Comes with a 12" base for stability
- Saddle comes with a removable saddle rubber cover to protect vehicle components
- Equipped with a foot pedal that allows easy load movement

SPECIFICATIONS

Ascot No.	Mfg. No.	Description
302-28112	2811B	1500 LB. High Reach Jack Stand W/ Foot Pedal

Ascot No.	Min. Hgt.	Max Hgt.	Base Size	Saddle Size	Ship Wt. (Lbs)
302-28112	54-3/4"	81-1/8"	12"	5-3/4" x 2-3/4"	30.8lbs

1500 LB. HIGH REACH JACK STAND

- Capacity: 1500 LB
- Underhoist stand is perfect for use with 2 or 4-post lifts, prevents tipping or rocking of the vehicle
- Heavy gauge steel frame prevents distortion or twisting
- Comes with a 12" base for stability
- Saddle comes with a removable saddle rubber cover to protect vehicle components

SPECIFICATIONS

Ascot No.	Mfg. No.	Description
302-02811	2811	1500 LB. High Reach Jack Stand

Ascot No.	Min. Hgt.	Max Hgt.	Base Size	Saddle Size	Ship Wt. (Lbs)
302-02811	54-3/4"	81-1/8"	12"	5-3/4" x 2-3/4"	28.6 lbs



302-28112
1500 lb. High Reach Jack Stand W/ Foot Pedal



302-02811
1500 lb. High Reach Jack Stand

ASCOT LIFTING EQUIPMENT

ASCOT

PROFESSIONAL JACKS



302-02812
2-Ton Underhoist
Tripod Jack Stand



2-TON UNDERHOIST TRIPOD JACK STAND

- Capacity: 2-Ton
- Underhoist stand is perfect for use with 2 or 4-post lifts, prevents tipping or rocking of the vehicle
- Heavy gauge steel frame prevents distortion or twisting
- Saddle comes with a removable rubber cover to protect load

SPECIFICATIONS

Ascot No.	Mfg. No.	Description
302-02812	2812	2-Ton Underhoist Tripod Jack Stand

Min. Hgt.	Max Hgt.	Base Size	Saddle Size	Ship Wt. (Lbs)
48-7/16"	83-1/16"	24-7/16" x 21-1/4"	5-7/16 x 1-9/16"	35.5 lbs



371-03321
1/2-Ton Two
Stage Telescopic
Transmission Jack

1/2-TON TWO STAGE TELESCOPIC TRANSMISSION JACK

- Foot pedals allow hands free operation
- Overload valve prevents jack from being used beyond its rated capacity
- Speed limiting valve ensures an automatic safe speed descent - not greater than 1" per second.
- "Hidden" hydraulic double pump system provides FAST lifting - under no load the jack can reach maximum height in 35 pumps
- The cover on the pump system helps keep dust and dirt out of the hydraulics for longer life
- Deluxe saddle with 2 angle adjustments - fore/aft and side to side - for maximum user flexibility.
- Includes a 59" tie down chain to secure the load.
- Chrome plated piston rod and pump core for longer service life.
- The grease fitting at the ram nut allows easy lubrication of the shafts.
- 4" steel swivel casters provide effortless maneuvering through the shop, 2 standard and 2 with locking mechanisms

SPECIFICATIONS

Ascot No.	Mfg. No.	Description
371-03321	HJ3321	1/2-Ton Two-Stage Telescopic Transmission Jack

Min. Hgt.	Max Hgt.	Saddle Tilt Forward/ Backward	Saddle Tilt Left/Right	Ship Wt. (Lbs)
37"	76-3/8"	29°/10°	27.2°/46.8°	158.4 lbs

ASCOT

PROFESSIONAL JACKS STANDS

ASCOT 3, 6 & 12-TON JACK STANDS

- Heavy-duty jack stands that are suitable for emergency tire changes, repairs and more
- Ratchet height adjustment built within column
- Wide base for added stability
- Multi-leveled ductile iron ratchet bar adds strength and durability
- Sold in pairs of two
- **NOW FEATURING A DOUBLE LOCK SAFETY PIN FOR ADDED SECURITY**

COMING SOON!
FALL 2024

302-63060



302-63030



302-63120



JACK STAND SPECIFICATIONS

Ascot No.	Mfg. No.	Capacity (Tons)	Base Size	Min. Height / Max. Height	Shipping Weight
302-63030	63030	3-Ton	7-5/8" x 6-7/8"	11" / 16-3/8"	14.9 lb.
302-63060	63060	6-Ton	11" x 9-3/4"	15-3/4" / 24-3/8"	32 lb.
302-63120	63120	12-Ton	11-3/4" x 10-5/8"	17-1/2" / 27-1/2"	56 lb.

www.ascotsupply.com

⚠️ WARNING: For more information go to www.P65Warnings.ca.gov.

LIFTING EQUIPMENT & ACCESSORIES



302-00200
2-Ton Low Profile Floor Jack

SUPER LOW
PICKUP
HEIGHT



2-TON LOW PROFILE FLOOR JACK

- Super low pickup height of 2-3/4"
- Equipped with a double pump design to increase speed without compromising performance
- Universal joint technology and precision release valve for a more controlled release
- Safety valve prevents overload
- Tough UV powder coated frame for greater protection and durability
- Pinned steel saddle (1" stud) with rubber pad for added vehicle protection and durability
- One-piece foam covered 50" handle for ease of positioning, pumping and storage.

Ascot No.	Mfg. No.	Description
302-00200	200T	2-Ton Low Profile Floor Jack

DOUBLE
PUMPER

TOP SELLER



302-35002
3.5-Ton Heavy Duty Floor Jack with Double Pumper

3.5-TON HEAVY DUTY FLOOR JACK WITH DOUBLE PUMPER

- Lifts from 4" to 19-1/2"
- Pinned steel saddle (1-1/8" stud) with rubber pad for added vehicle protection
- Rear-mounted 2-3/4" swivel casters for ease of maneuverability
- One piece 50-1/4" padded handle parks upright
- Handle ships separately
- Equipped with a double pump design to increase speed without compromising overall performance of the jack
- Second volume pump assists in getting the saddle to load much quicker than most other single pump designs on the market today

Ascot No.	Mfg. No.	Description
302-35002	350SS	3.5 Ton Heavy Duty Floor Jack with Double Pumper



302-55200
20-Ton Air/Hydraulic Bottle Jack

20-TON AIR/HYDRAULIC BOTTLE JACK

- 90-180 PSI
- Factory pre-tested to 150% of rated capacity
- Safety bypass system
- Dual ram return springs
- Saddles are machine-hardened steel

Ascot No.	Mfg. No.	Capacity	Base Size	Min. Height	Max. Height	Lift	Ext. Screw	Shipping Weight
302-55200	5520B	20-Ton	9-1/2" x 6-1/2"	10-1/2"	20"	6-1/4"	3-7/8"	39 lb.

LIFTING EQUIPMENT & ACCESSORIES



**20 AND 30-TON CAPACITY
SUPER DUTY AIR/HYDRAULIC
BOTTLE JACKS**

- **WELDED TANK AND FRAME:** For superior strength, leak-free operation and stronger performance in rough service conditions and in the case of off-center loading
 - **THICK BASE:** 1-1/8" Thick base design offers the most stable lifting platform even on poor surfaces
 - **HEAVY DUTY:** High-strength steel ram and cylinder supported by a longer ram guide for improved safety in off-center load conditions
 - **DUAL RETURN SPRINGS:** Dual return springs help provide controlled and easy descent
 - **SHIELDED RELEASE**
- **SCREW:** Heavy duty shielded internal release screw is protected by base design to prevent accidental release/damage
 - **PROVEN AIR MOTOR:** Quality tested and field tested to ensure consistent, reliable operation
 - Can be operated either manually or by air or manually
 - *Handle included*
 - Hose swivels for ease of operation
 - ASME 2009 compliant



301-05620
20-Ton Super Duty Air/ Hydraulic Bottle Jack



301-05621
20-Ton Super Duty Air/ Hydraulic Bottle Jack



301-05630
30-Ton Super Duty Air/ Hydraulic Bottle Jack



Ascot No.	Mfg. No.	Cap.	Base Size	Min. Height	Max. Height	Lift	Air Pressure	Air Inlet Fitting	Ship Wt.
301-05620	5620SD	20-Ton	5-3/4" x 9"	10-37/100"	20-63/100"	6-19/50"	110-120 PSI	1/4" NPT	45 lb.
301-05621	5621SD	20-Ton	5-7/10" x 8-27/100"	7"	12-3/4"	3-7/20"	110-120 PSI	1/4" NPT	36 lb.
301-05630	5630SD	30-Ton	9-13/20" x 7-9/100"	10-47/50"	20-59/100"	5-91/100"	110-120 PSI	1/4" NPT	65 lb.

LIFTING EQUIPMENT & ACCESSORIES



TWIN HYDRAULIC SYSTEM

302-40000
4-Ton Heavy Duty Floor Jack



4-TON HEAVY DUTY FLOOR JACK

- Twin hydraulic system for fast and efficient lifting
- Heavy duty pump, ram, and cylinders are precision machined and inspected to ensure long service life
- High grade U-cup seals and high pressure plunger for maximum performance
- Rear mounted swivel casters for easy maneuverability
- Universal joint technology provides a more controlled descent
- Pinned and padded saddle for extra vehicle protection
- Flanged side plates for increased stability
- Integrated parts tray keeps small components from getting lost
- Meets ASME 2014 standards

Ascot No.	Mfg. No.	Description
302-40000	400SS	4-Ton Heavy Duty Floor Jack

TOP SELLER

HEAVY DUTY LIFTING

302-56502
22-Ton Air/Hydraulic Axle Jack



22-TON AIR/HYDRAULIC AXLE JACK

- Heat-treated cylinder wall & chromed piston give added stability & longer jack life
- Alloy steel lifting mechanism for added durability and operator safety
- Precision engineered tolerances for maximum performance
- In-line filter to protect air motor from contaminants
- Corrosion-resistant aluminum and nylon composite air motor
- Ram extension kit included with 3/4", 2-3/4" and 4" extensions
- Large 7-3/4" rear wheels for easy positioning
- Automatic in-line oiler to lubricate air motor
- Grommet retainers - no need for clevis pin

Ascot No.	Mfg. No.	Description
302-56502	565F1	22-Ton Air/Hydraulic Axle Jack



3, 6 & 12-TON JACK STANDS

- Ratchet height adjustment built within column
- Wide base for added stability
- Multi-leveled ductile iron ratchet bar adds strength and durability
- **Sold in pairs of two**
- **NOW FEATURING A DOUBLE LOCK SAFETY PIN FOR ADDED SECURITY**

Ascot No.	Mfg. No.	Capacity	Base Size	Min. Height	Max. Height	Shipping Weight
302-63030	63030	3-Ton	7-5/8" x 6-7/8"	11"	16-3/8"	14.9 lb.
302-63060	63060	6-Ton	11" x 9-3/4"	15-3/4"	24-3/8"	32 lb.
302-63120	63120	12-Ton	11-3/4" x 10-5/8"	17-1/2"	27-1/2"	56 lb.

DOUBLE LOCK PIN



302-63060
6-Ton Jack Stands

302-63120
12-Ton Jack Stands

10-TON HIGH JACK STANDS (PAIR)

- Pin-style stands with supporting range from 27.95" to 47.56" suitable for high-height applications
- Heavy-duty tubular steel design provides stability and rigidity
- Multiple pin holes to allow easy adjustment to desired height
- Saddle with lugs for easy positioning of the load
- **Sold and to be used only in pairs**

Ascot No.	Mfg. No.	Capacity	Base Size	Min. Height	Max. Height	Shipping Weight
302-51005	510005	10	16-7/32" x 16-7/32"	27-61/64"	47-9/16"	123.2 lb.



302-51005
10-Ton High Jack Stands (Pair)

LIFTING EQUIPMENT & ACCESSORIES



301-14460
20-Ton Titan Air/
Hydraulic Bottle Jack

TITAN 20-TON AIR/HYDRAULIC BOTTLE JACK

- Chromed ram and aluminum air motor for long life
- Heavy duty return springs
- Each unit factory tested at 150% overload
- **CAPACITY:** 20-Ton
- **MIN. HEIGHT:** 9.7" (24.5 cm)
- **MAX. HEIGHT:** 18.5" (46 cm)
- **WEIGHT:** 38 lb. (17.5 kg)



Ascot No.	Mfg. No.	Description
301-14460	14460	Titan 20-Ton Air/Hydraulic Bottle Jack



301-14461
20-Ton Short Titan Air/
Hydraulic Bottle Jack

**TITAN 20-TON SHORT AIR/
HYDRAULIC BOTTLE JACK**

- Cylinder is welded to the base, assuring strength and eliminating leaks
- Chromed pump piston and ram for added rust resistance
- Extension screw gives added height when necessary
- Super low minimum height for easy access
- Meets ANS/ASME PALD & CE/GS standards
- **MEASUREMENTS (L X W X H):**
13" x 5" x 6"
- **MIN. HEIGHT:** 5.8" (148 mm) **MAX. HEIGHT:** 10" (256 mm)
- **WEIGHT:** 9.5 kg/21 lb.

Ascot No.	Mfg. No.	Description
301-14461	14461	Titan 20-Ton Short Air/Hydraulic Bottle Jack

LIFTING EQUIPMENT & ACCESSORIES

WINNTEC 3.5-TON FAST LOCK JACK BLOCK

- Ultimate solution for transforming your floor jack quickly into a secure jack stand
- Extends 217mm (8.54") to 342mm (13.88") and is equipped with a spring release for easy positioning
- Works with most floor jacks
- Quick install spring release
- Safety pin for double safety
- A must have for quickly and safely supporting all kinds of vehicles, especially those that don't show multiple lift/support points
- Highly recommended for those workshops and mobile operators that service EV's

Ascot No.	Mfg. No.	Description
302-45035	Y450350	Winntec 3.5-Ton Fast Lock Jack Block



FAST LOCK JACK BLOCK IN USE



302-45035
Fast Lock Jack Block



ROLLER PLATE FOR GAITHER TRAC TIRE JACK

- When used with the Gaither TRAC tire jack, the roller plate allows for an easier alignment of the holes of the wheels to the studs of the hub
- Dimensions: 8" x 5" x 1.25"
- Weight: 2 lbs.
- Heavy duty welded steel construction offers extreme durability
- Steel base roller offers tire support and rolling convenience

Ascot No.	Mfg. No.	Description
309-48511	GTRP-01	Roller Plate for Gaither Trac Tire Jack



309-48511
Fast Lock Jack Block

GAITHER TRAC TIRE JACK

- Tool helps technicians when mounting and demounting heavy wheel assemblies to and from a vehicle's hub
- The TRAC Tire Jack slides under the tire and wheel and allows the technician to roll the wheel into place
- Through the use of leverage, the TRAC Tire Jack saves users time and their backs
- Heavy-duty welded steel construction offers extreme durability
- Steel base roller

Ascot No.	Mfg. No.	Description
309-48501	GTJ-01	Gaither TRAC Tire Jack

309-48501
Gaither TRAC Tire Jack



ROLLER PLATE IN USE

HEAVY DUTY TIRE DOLLY

- Reduce back injuries
- Perfect stud alignment
- Perfect for 8 to 10-hole Budd-type wheels
- Removes truck wheels and tires quickly and easily
- Increases productivity
- Reduces manpower needs
- Saves time and money, maintenance free
- Works with tires 19.5" - 24.5"

Ascot No.	Mfg. No.	Description
407-03000	BJ-T300A	Heavy Duty Tire Dolly



407-03000
Heavy Duty Tire Dolly

LIFTING EQUIPMENT & ACCESSORIES

O-LINE-ER STUD ALIGNMENT TOOL



491-00101
O-LINE-ER Stud Alignment Tool

- Slides over the stud and acts as a guide for the technician to line up the studs on the truck with the holes on the wheel
- Minimizes installation time
- Reduces injury risk when dealing with heavy tires and wheels when combined with the tire dolly

Ascot No.	Mfg. No.	Description
491-00101	GTO-01B	O-LINE-ER Stud Alignment Tool

3/8" HYDRAULIC HOSES



318-04960
3/8" 8' Hydraulic Hose

318-04960
3/8" 10' Hydraulic Hose

- 10,000 PSI Working Pressure, 20,000 PSI Burst Pressure
- High flow valve for fast inflation
- Includes half coupler and plastic dust cover

Ascot No.	Mfg. No.	Description
318-04960	9010-08	8' Hydraulic Hose Assembly
318-04120	9010-10	10' Hydraulic Hose Assembly

HYDRAULIC COUPLERS

- High-flow hydraulic coupler, 10,000 PSI working pressure
- **Made in Italy**

Ascot No.	Mfg. No.	Description
135-10605	PVV-38-M	3/8" Male Hose Half Coupler (For Hydraulic Rams)
135-10606	PVV-38-F	3/8" Female Ram Half Coupler (For Hydraulic Rams)

HYDRAULIC COUPLER SET

- **SET CONTAINS:** Male (Hose Half) Coupler, Female (Ram Half) Coupler, Plastic Dust Cover
- **Made in Italy**

Ascot No.	Mfg. No.	Description
135-10607	10607	Hydraulic Coupler Set

HYDRAULIC QUICK CONNECT COUPLER/PLUG

- 10,000 PSI maximum operating pressure
- Safety sleeve lock prevents accidental disconnection
- Heavy duty back-up ring
- provide excellent high and low pressure seating
- Heat treated and plated steel
- Self-sealing poppet valves
- **Coupler equivalent to Parker TC-371**
- **Plug equivalent to Parker TC-372**
- **Made in Italy**

Ascot No.	Mfg. No.	Description
135-11606	FD35-1001-0606	Hydraulic Quick Connect Coupler
135-12606	FD35-1002-0606	Hydraulic Quick Connect Plug

RUBBER DUST COVER FOR HYDRAULIC COUPLERS

- Hydraulic coupler dust cap
- Used to keep dirt and debris from your hydraulic coupler when not connected
- Made of a durable rubber material
- Equipped with a pre-slit ring to allow coupler to slide easily over the counter
- **Comes standard with 8' and 10' hydraulic hoses**

Ascot No.	Mfg. No.	Description
319-03732	O3-RDC	Rubber Dust Cover for Hydraulic Couplers



135-10605
3/8" Male Hose Half Coupler

135-10606
3/8" Female Ram Half Coupler

135-10607
Hydraulic Coupler Set

135-11606
Hydraulic Quick Connect Coupler

135-12606
Hydraulic Quick Connect Plug

319-03732
Rubber Dust Cover for Hydraulic Couplers

PORTABLE HYDRAULICS & JACK PLATES

55-TON ALUMINUM RAM

- 6" stroke
- Lightweight aluminum for ease of handling
- Includes "Shut-Off-Valve" which allows the pump to be removed while the ram is extended
- Aluminum base plate for a larger footprint and added stability
- **CAPACITY:** 55 tons
- **HEIGHT (COLLAPSED):** 12.25" (31cm)
- **EXTENDED HEIGHT:** 18.25" (46 cm)
- **SADDLE DIAMETER:** 3" (7.5 cm)
- **NET WEIGHT:** 29 lb. (13.15 kg)



318-13120
55-Ton Aluminum Ram



Ascot No.	Mfg. No.	Description
318-13120	N/A	55-Ton Aluminum Ram

55-TON ALUMINUM RAM W/ LOCKING COLLAR

- Aluminum lock nut provides mechanical load holding for extended periods
- Composite bearings increase cylinder life and side load resistance
- Equipped with bolt-on hardened steel saddle
- Hard coat finish resists damage and extends cylinder life
- Stroke: 6" (15 cm)
- Retracted Height: 13.2" (33.5 cm)
- Max. Height: 19.1" (48.5 cm)
- Weight: 26.2 lbs (11.9 kg)

318-13154
55-Ton Aluminum Ram W/ Locking Collar



Ascot No.	Mfg. No.	Description
318-13154	13154	55-Ton Aluminum Ram W/ Locking Collar

100-TON ALUMINUM RAM W/ LOCKING COLLAR

- Aluminum lock nut provides mechanical load holding for extended periods.
- Composite bearings increase cylinder life and side load resistance
- Equipped with bolt-on hardened steel saddle
- Hard coat finish resists damage and extends cylinder life
- Stroke: 6" (15 cm)
- Retracted Height: 15.6" (39.6 cm)
- Max. Height: 21.5" (54 cm)
- Weight: 58 lbs (26 kg)

318-13155
100-Ton Aluminum Ram W/ Locking Collar



Ascot No.	Mfg. No.	Description
318-13155	13155	100-Ton Aluminum Ram W/ Locking Collar

100-TON ALUMINUM RAM

- Lightweight aluminum for ease of handling
- Includes "Shut-Off-Valve" which allows the pump to be removed while the ram is extended
- **CAPACITY:** 100 tons
- **HEIGHT (COLLAPSED):** 12" (30.5 cm)
- **EXTENDED HEIGHT:** 18" (48 cm)
- **SADDLE DIAMETER:** 3" (7.5 cm)
- **NET WEIGHT:** 53 lb. (24 kg)



The 100-Ton Aluminum Ram in use.



318-13000
100-Ton Aluminum Ram

Ascot No.	Mfg. No.	Description
318-13000	13000	100-Ton Aluminum Ram (Jack) - 6" Stroke



PORTABLE HYDRAULICS & JACK PLATES



- NON-SKID SURFACE
- LIGHT AND EASY TO HANDLE

309-14464
12" x 12" x 1"
Jack Plate

50-TON CAPACITY JACK PLATE

- Each unit has non-skid surface to prevent the jack from sliding under wet or oily conditions
- The base of the jack can be blocked or cribbed for additional stability
- Lightweight and easy to handle
- **DIMENSIONS:** 12" x 12" x 1"
- **CAPACITY:** 50-ton
- **WEIGHT:** 5 lb.

Ascot No.	Mfg. No.	Description
309-14464	14464	12" x 12" x 1" 50-Ton Capacity Jack Plate



- NON-SKID SURFACE
- LIGHT AND EASY TO HANDLE

309-14465
12" x 12" x 1.5"
Jack Plate

100-TON CAPACITY JACK PLATE

- Each unit has non-skid surface to prevent the jack from sliding under wet or oily conditions
- The base of the jack can be blocked or cribbed for additional stability
- Lightweight and easy to handle
- **DIMENSIONS:** 12" x 12" x 1.5"
- **CAPACITY:** 100-ton
- **WEIGHT:** 8 lb.

Ascot No.	Mfg. No.	Description
309-14465	14465	12" x 12" x 1.5" 100-Ton Capacity Jack Plate



- NON-SKID SURFACE
- LIGHT AND EASY TO HANDLE

309-14472
18" x 18" x 1"
Jack Plate

50-TON CAPACITY JACK PLATE

- Each unit has non-skid surface to prevent the jack from sliding under wet or oily conditions
- The base of the jack can be blocked or cribbed for additional stability
- Lightweight and easy to handle
- **DIMENSIONS:** 18" x 18" x 1"
- **CAPACITY:** 50-ton
- **WEIGHT:** 14 lb.

Ascot No.	Mfg. No.	Description
309-14472	14472	18" x 18" x 1" 50-Ton Capacity Jack Plate

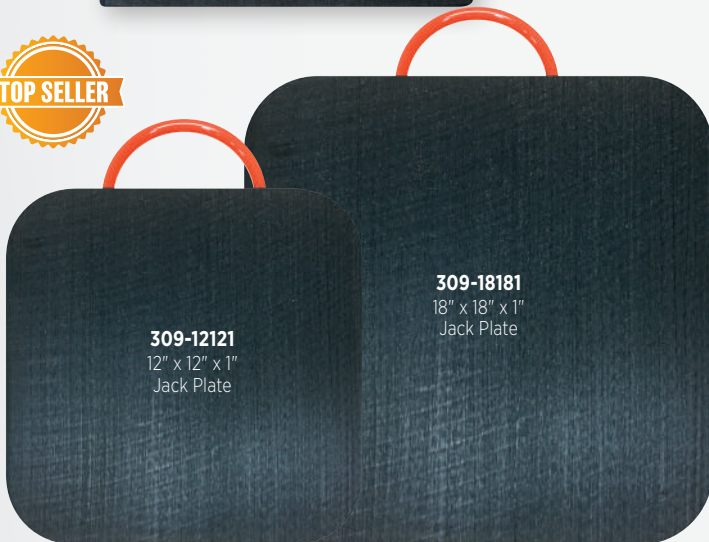

309-12121
12" x 12" x 1"
Jack Plate

309-18181
18" x 18" x 1"
Jack Plate

100-TON CAPACITY JACK PLATES

- **Sizes available:** 12" x 12" x 1" and 18" x 18" x 1"
- 100-ton capacity for both sizes
- Constructed of engineered thermoplastic material
- Provides stability to bottle jacks, hydraulic rams, jack stands and cribbing
- Non-skid surface
- **MADE IN THE USA**

Ascot No.	Mfg. No.	Description
309-18181	D1818	18" x 18" x 1" Jack Plate
309-12121	D1212	12" x 12" x 1" Jack Plate

MISCELLANEOUS MECHANIC'S TOOLS

TPMS CHROME FLIP SOCKET/EXTENSION KIT

- 1/4" drive 11mm x 12mm chrome flip socket
- Unique flip socket design is the key to the easy installation and removal of TPMS sensors
- Both pieces made of chrome vanadium
- 1/4" drive x 2" chrome extension

Ascot No.	Mfg. No.	Description
167-01012	TMRTR1012	TPMS Chrome Flip Socket/ Extension Kit

TPMS CHROME FLIP SOCKET/SOCKET DRIVER KIT

- 1/4" drive 11mm x 12mm chrome flip socket
- 1/4" drive screwdriver handle socket driver - 6" overall length - 2-1/2" shank length
- Unique flip socket design is the key to the easy installation and removal of TPMS sensors
- Socket is made of chrome vanadium
- Socket driver is **MADE IN THE USA**

Ascot No.	Mfg. No.	Description
167-01015	TMRTR1015	TPMS Chrome Flip Socket/Socket Driver Kit

1/4" SOCKET DRIVER

- Ideal for use with the TPMS 11mm x 12mm flip socket
- Screwdriver handle, made from durable plastic-like material
- Shank made from chrome vanadium
- 6" overall length
- 2-1/2" shank length
- **MADE IN THE USA**

Ascot No.	Mfg. No.	Description
319-72521	7252100	1/4" Socket Driver (Screwdriver Handle)

HOLD-A-ROTOR BRAKE ROTOR SECURING TOOL - 2 PACK

- Effortless Installation: The Hold-A-Rotor™ eliminates the need for finding and screwing on a nut, allowing fast and hassle-free rotor securing. This saves time and simplifies brake repairs.
- Versatile Fit: Available in 12mm (Green) and 14mm (Red), the Hold-A-Rotor™ fits the most common stud sizes for passenger vehicles and light trucks, covering a wide range of applications.
- Hands-Free Operation: Once the tool is slipped onto the stud, it locks the rotor securely in place, freeing up your hands to focus on completing brake repairs more efficiently.
- Protects Wheel Studs: The durable ABS material of the Hold-A-Rotor™ prevents damage to wheel studs, reducing the risk of needing replacements and prolonging the life of the components.
- Durable Construction: Made from oil and grease-resistant ABS, the Hold-A-Rotor™ withstands tough working conditions, ensuring long-lasting performance for technicians and DIYers alike.

Ascot No.	Mfg. No.	Description
411-71000	STC1000	Hold-A-Rotor Brake Rotor Securing Tool - 2 Pack



167-01012
TPMS Chrome Flip Socket/ Extension Kit



167-01015
TPMS Chrome Flip Socket/ Socket Driver Kit

319-72521
1/4" Socket Driver



NEW
411-71000
Hold-A-Rotor

MISCELLANEOUS MECHANIC'S TOOLS

SPARE TIRE TOOL SET

- No more digging through the customer's vehicle to locate the spare tire removal kit
- Applications include many trucks & SUVs where the spare tire is located under the vehicle
- Color-coded wall bracket allows user to quickly identify the correct removal tool
- Allows anyone to quickly remove difficult to reach spare tires

Ascot No.	Mfg. No.	Description
319-96090	96090A	Spare Tire Tool Set



INDIVIDUAL SPARE TIRE TOOLS

Ascot No.	Mfg. No.	Description
319-96091	96091	Spare Tire Tool - Flat Head - Red: For use on late model S10 trucks, Explorers, Blazers, Jimmys, F150s, Expeditions, older Dakota 2 wheel drives and McGuard lock systems
319-96092	96092	Spare Tire Tool - Pin Head - Blue: For use on import trucks
319-96093	96093	Spare Tire Tool - Hex Head - Yellow: For use on Dodge full size and stake bodies, '98-'01 Dodge full-size 4-wheel drive
319-96094	96094	Spare Tire Tool - 12mm Square Head - Green: For use on all late model GMs, remaining '98-'03 Dodge trucks
319-96095	96095	Spare Tire Tool - Std. Square Head - Orange: For use on older Ford Trucks

319-96090
Spare Tire Tool Set



MISCELLANEOUS MECHANIC'S TOOLS

OTR WHEEL CHOCK

- **DIMENSIONS:** 12" x 10" x 12"
- Designed for heavy duty truck and mining equipment
- 20" rope attached for convenience
- **NET WEIGHT:** 27.5 lb.
- Durable rubber construction
- Features an eye bolt for chain or rope attachment
- Ribbed pyramid design
- Either side of wheel chock can be positioned

396-00102
OTR Wheel Chock



Ascot No.	Mfg. No.	Description
396-00102	TS102	OTR Wheel Chock

RUBBER WHEEL CHOCK

- Durable rubber construction
- Features an eye bolt for chain or rope attachment
- Ribbed pyramid design
- Either side of wheel chock can be positioned against the tire
- Sold individually
- **NET WEIGHT:** 10 lb. (4.5 kg)



396-15300
Rubber Wheel Chock

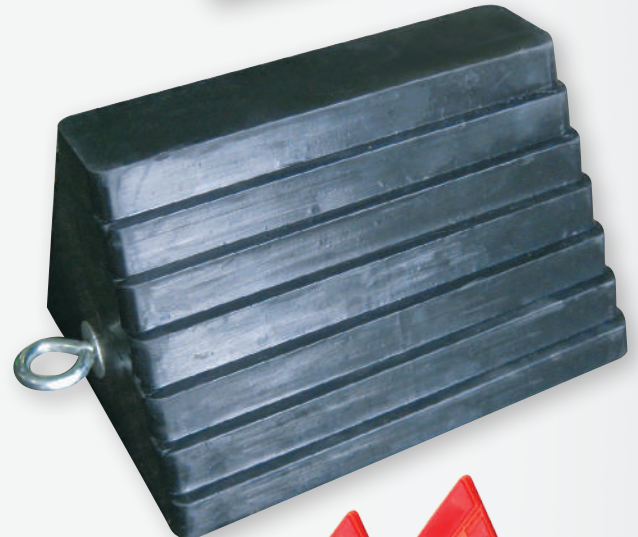

The Rubber Wheel Chock in use.

Ascot No.	Mfg. No.	Description
396-15300	15300	Rubber Wheel Chock

3-PIECE ROADSIDE EMERGENCY TRIANGLE KIT

- Set of 3 includes carrying case
- High visibility during daytime and nighttime
- Reinforced cross base
- Foldable for easy storage
- Large 17" x 17" triangle
- **Made in China**

COMING SOON!
FALL 2024

396-00003
3-Piece Emergency Triangle Kit



Ascot No.	Mfg. No.	Description
396-00003	3P-RETK	3-Piece Roadside Emergency Triangle Kit

INTERIOR PROTECTION PRODUCTS



399-99432
Plastic
Floor Mat

PLASTIC FLOOR MAT

- Slip-N-Grip® two-layer construction ensures plastic floor mat stays in place
- Impervious to water, oil, grease and most shop chemicals

Ascot No.	Mfg. No.	Description
399-99432	M-FG-P9943-02	Plastic Floor Mat (500 per roll)



399-74980
Prime Heavy
Duty Paper
Floor Mats

PRIME HEAVY DUTY PAPER FLOOR MATS

- Treated/coated mats, made from premium prime/virgin paper
- Keeps dirt, grease, oil, spills, leaks and other shop fluids out of your customer's vehicle during service
- Prime paper is suitable for all weather climates and heavy foot traffic
- Prime paper directly from paper mill provides same consistent quality every time
- Printed with UV ink
- Bright white paper produces vibrant, full color prints
- Recyclable
- **QUANTITY:** 500 per box
- **SIZE:** 17" x 19"

Ascot No.	Mfg. No.	Description
399-74980	M3273PP2280A	Prime Heavy Duty Paper Floor Mats

INTERIOR PROTECTION PRODUCTS

PLASTIC KEY TAG

- Self-locking design holds keys secure
- Perfect for quickly tagging keys in a busy service area
- Large writing surface
- Holes are fully punched out eliminating “chads”

Ascot No.	Mfg. No.	Description
399-99323	M-FB-P9933-23	Plastic Key Tag (1000 per package)

399-99323
Plastic Key Tag



PAPER KEY TAG

- Cost-effective, convenient solution for key control
- Metal ring
- **QUANTITY:** 1,000 per box
- **SIZE:** 1.5" x 2.75"



The Paper Key Tag in use.

399-98313
Paper Key Tag



Ascot No.	Mfg. No.	Description
399-98313	M-FB-P9833-13	Paper Key Tag with Metal Ring (1000 per box)

GENERIC ADHESIVE TIRE LABEL

- Features sure-grip adhesive
- Proper used tire labeling sells tires
- **QUANTITY:** 500 per roll
- These labels will catch your customer’s eye and promote sales

Ascot No.	Mfg. No.	Description
399-99479	M-FB-P9943-79	Generic Print Adhesive Tire Label (500 per roll)

399-99479
Generic Adhesive Tire Label



INTERIOR PROTECTION PRODUCTS



399-99302
Work Ticket Holder

WORK TICKET HOLDER

- Heavy-duty sewn nylon fabric handle ensures durability even in harsh conditions
- Durable brass grommet increases strength
- **QUANTITY:** 25 per box
- **SIZE:** 10.5" x 14.5" with handle, top open



The Work Ticket Holder in use.



Ascot No.	Mfg. No.	Description
399-99302	M-FB-P9933-02	Clear Front & Back Work Ticket Holder (25 per box)



399-99433
Steering Wheel Cover

STEERING WHEEL COVER

- Keeps grease, dirt and other shop chemicals off of one of the most noticeable and expensive parts of the car
- Reusable/disposable steering wheel covers are made of clear polyethylene with stretch elastic grip feature
- Elastic design is easier to apply and remove than stretch wrap covers
- Unique double-band steering wheel covers stays in place while allowing access to airbags



Ascot No.	Mfg. No.	Description
399-99433	M-FB-P9943-33	Standard Size Double Band Steering Wheel Cover: <ul style="list-style-type: none"> • Size: 5" wide • Fits up to 24" Steering Wheel up to 15.2" in diameter • Covers virtually all passenger cars and light trucks • Quantity: 500 per box

COMING SOON!
FALL 2024



396-00357
EVA Foam Kneeling Pad

EVA FOAM KNEELING PAD

- 3-layer foam material
- Built-in Handle
- Extremely durable
- Works on any surface
- Chemical resistant
- Can be used as seat protection as well
- **Made in Taiwan**

Ascot No.	Mfg. No.	Description
396-00357	NS-KP480320	EVA Foam Kneeling Pad

www.ascotsupply.com

⚠️ WARNING: For more information go to www.P65Warnings.ca.gov.

INTERIOR PROTECTION PRODUCTS

PLASTIC SEAT COVER

- **SLIP-N-GRIP® SEAT COVERS HAVE TWO DISTINCT LAYERS:** the bottom layer grips the seat to stay in place and the top layer is smooth to allow easy entry and exit from the vehicle
- Protects bucket, bench and split seats
- **Made In USA**

Ascot No.	Mfg. No.	Description
399-99415	M-FG-P9943-15C	Plastic Seat Cover (500 per roll)



399-99415
Plastic Seat Cover

PLASTIC TIRE BAG

- 40% post-consumer recycled resin
- White film hides dirty tire
- Ideal for returning old tires or snow tires for storage
- **Made In USA**



The Plastic Tire Bag in use.

Ascot No.	Mfg. No.	Description
399-99391	M-FG-P9933-91	Extra Large Tire Bag 47" x 48" x 1.25 Mil (125 per roll)
399-99392	M-FG-P9933-92	SNG SUV Tire Bag 39" x 44" (250 per roll)
399-99429	M-FG-P9943-29C	Plastic Tire Bag 36" x 40" (250 per roll)



399-99429
Plastic Tire Bag

FLOOR DISPENSER RACK

- Industry-leading dispenser system keeps products organized and within reach
- Retention straps prevent free-rolling and locking casters keep dispenser in place
- Top tray holds paper floor mats and other service items while lower tray provides extra storage
- Presents "We Care" image and promotes cleanliness

Ascot No.	Mfg. No.	Description
399-98893	M-FB-P9833-89B	Floor Dispenser Rack



399-98893
Floor Dispenser Rack

WHEEL & RIM DISMOUNTING TOOLS & ACCESSORIES



9
PIECES

163-02849
1/2" DR Extra Thin Wall 9-Piece SAE & Metric Wheel Protector Socket Set

1/2" DR EXTRA THIN WALL 9-PIECE SAE & METRIC WHEEL PROTECTOR SOCKET SET

- Durable outer sleeve and insert protects high polished wheels and lug nuts from damage
- CR-MO alloy steel for long life
- Fully guaranteed
- Heavy duty blow mold case
- **6 SAE SOCKETS:** 3/4" (light green), 13/16" (purple), 7/8" (green), 15/16" (brown), 1" (silver) and 1-1/16" (black)
- **3 METRIC SOCKETS:** 17mm (blue), 19mm (yellow) and 21mm (red)
- **Made In Taiwan**

***REPLACEMENT SOCKETS FOR 2849 SET**

Ascot No.	Mfg. No.	Description
163-28492	28492	1/2"x3/4"
163-28494	28484	1/2"x13/16"
163-28496	28496	1/2"x7/8"
163-28498	28498	1/2"x15/16"
163-28917	284917	1/2"x17mm
163-28919	284919	1/2"x19mm
163-28921	284921	1/2"x21mm

Ascot No.	Mfg. No.	Description
163-02849	12849	1/2" DR Extra Thin Wall 9-Piece SAE & Metric Wheel Protector Socket Set



492-00502
5-Piece 1/2" Drive Twist Socket Set

5
PIECES

5-PIECE 1/2" DRIVE TWIST SOCKET SET

- Designed to easily remove damaged, rounded nuts
- Use with 1/2" drive impact wrench or breaker bar
- CR-MO steel for long life
- Heavy duty blow molded case
- **INCLUDES:** 17mm, 19mm, 21mm & 22mm twist sockets plus a 50mm extractor punch
- **Made In Taiwan**



Ascot No.	Mfg. No.	Description
492-00502	TSS5	5-Piece 1/2" Drive Twist Socket Set



163-22219
4-Piece 1/2" Drive Flank Bite Socket Set

4
PIECES

1/2" DRIVE 4-PIECE FLANK BITE DAMAGED NUT REMOVER SOCKET SET

- New Flank Bite design works on up to an industry leading 90% rounded lug nut
- Also safe for forward tightening of lug nuts without damage
- Contains the following sizes: 17mm, 19mm, 21mm, 22mm
- Individual sockets also available separately: 17mm (163-22017), 19mm (163-22019), 21mm (163-22021), 22mm (163-22022)
- **Made In Taiwan**

Ascot No.	Mfg. No.	Description
163-22219	122019K2	1/2" Drive 4-Piece Flank Bite Damaged Nut Remover Socket Set

WHEEL & RIM DISMOUNTING TOOLS & ACCESSORIES

1/2" DRIVE 13-PIECE WHEEL LOCK REMOVAL KIT

For Ford, Chrysler & GM Vehicles as well as standard and oversized OEM and after-market wheel locks for other domestic and imported cars and light trucks.

KIT CONTAINS:

- Ford, Chrysler & Large GM Lock Remover, GM Spline Hub-lock Adapter
- Standard GM Hubcap Locks, Stripped 18mm/GM Wheel Cover Adapter
- Corvette-GM N & F Body Adapter, Standard Ford & GM/Large Wheel Adapter
- Oversized McGuard Wheel Lock Adapter, Punch
- Late Model Chrysler Lock Adapter, 1/2" Dr. 18mm Nut/Corvette GM Lock Remover
- 3/4", 19mm, OS Wheel Lock Remover, 7/8" OS Wheel Lock Remover
- 1/2" x 3" Impact Extension
- **Made In Taiwan**



401-02841
1/2" Drive 13-Piece
Wheel Lock Removal Kit

Ascot No.	Mfg. No.	Description
401-02841	12840-13	1/2" Drive 13-Piece Wheel Lock Removal Kit

1/2" DRIVE 9-PIECE WHEEL LOCK REMOVAL KIT

KIT CONTAINS:

- GM Hubcap Lock Remover, GM Sprocket Hubcap Remover, Ford and Chrysler Hubcap Lock Remover, Large Universal Locking Lug Nut Remover, Large Wheel Cover Lock Remover, Fits Stripped 18mm Lug Nuts, Oversize Wheel Lock Remover, GM "M" and "F" Body Wheel Lock Remover, Lug Nut Remover Punch
- **Made In Taiwan**



401-02840
9-Piece Wheel
Lock Remover Kit

Ascot No.	Mfg. No.	Description
401-02840	2840	9-Piece Wheel Lock Remover Kit

WHEEL & RIM DISMOUNTING TOOLS & ACCESSORIES

402-01283
16-Piece Locking Lug Key Set

16-PIECE LOCKING LUG KEY SET

- Heat treated chrome vanadium steel construction
- Easily removes locking lug nuts
- Thin wall sockets prevent damage to wheels
- Extra long lug keys keep your wrench away from the wheel preventing nicks and scratches
- Double hex head design fits most lug wrenches
- Packed in blow molded case with color sleeve
- **Made In Taiwan**

**16
PIECES**

KIT CONTAINS:

- **HEX:** 11mm, 12mm, 14mm, 15mm, 16mm, 17mm, 18mm, 19mm, 20mm
- **SOCKETS INCLUDED:** (2) 5/8", 41/64", 45/64", (2) 15/32", 19/32", (2) 11/16", 3/4", 7/16", 5/8", (2) 1/2", 13/16", 9/16"



Ascot No.	Mfg. No.	Description
402-01283	CHT1283	16-Piece Locking Lug Key Set
402-28301	1283-1	7-Spline Small Diameter Lug Nut Socket - 3/4" Inner Diameter
402-28302	1283-2	7-Spline Small Diameter Lug Nut Socket - 11/16" Inner Diameter
402-28305	1283-5	10-Point Star Lug Nut Key - 1/2" Tip Outer Diameter
402-28306	1283-6	8-Point Star Lug Nut Key - 5/8" Tip Outer Diameter
402-28307	1283-7	8-Point Star Lug Nut Key - 7/16" Tip Outer Diameter
402-28308	1283-8	9-Point Star Lug Nut Key - 1/2" Tip Outer Diameter
402-28309	1283-9	6-Spline Small Diameter Lug Nut Socket - 45/64" Inner Diameter
402-28310	1283-10	6-Spline Small Diameter Lug Nut Socket - 41/64" Inner Diameter
402-28316	1283-16	12-Spline Small Diameter Lug Nut Socket - 11/16" Inner Diameter

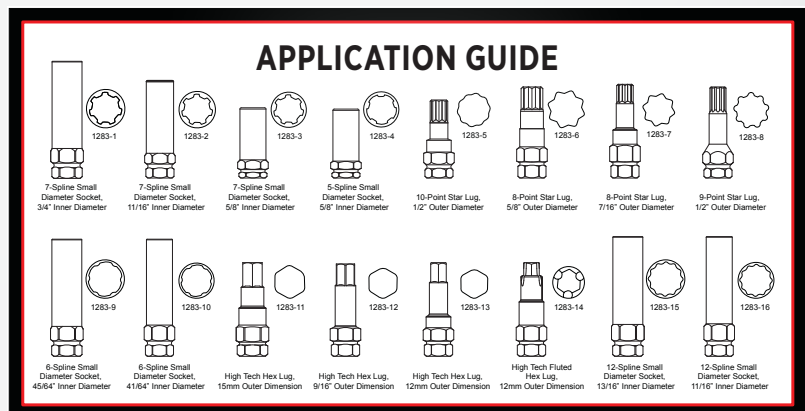

WHEEL & RIM DISMOUNTING TOOLS & ACCESSORIES

STUD CLEANING TOOLS

- Allows for cleaning the full length of the thread on 10 studs in less than 3 minutes
- Works with air or hand tools
- 1/2" adapter included with each tool
- Replacement Brushes Available*
- **CAUTION: Always use eye protection**

***REPLACEMENT BRUSHES FOR STUD CLEANING TOOLS**

Ascot No.	Mfg. No.	Description
402-00113	SBR13	13mm (1/2") Repl. Brush
402-00114	SBR14	14mm (9/16") Repl. Brush
402-00116	SBR16	16mm (5/8") Repl. Brush
402-00122	SBR22	22mm (7/8") Repl. Brush
402-00128	SBR28	28mm (1-1/8") Repl. Brush

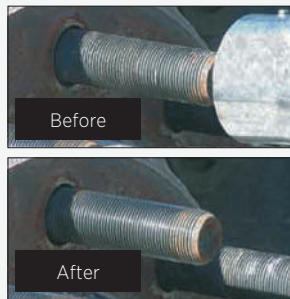

Stud Cleaning Tool in use.



402-00013
13mm (1/2")
Stud Cleaning
Tool



402-00122
22mm Replacement
Brush for Stud
Cleaning Tool

Ascot No.	Mfg. No.	Description
402-00013	SBCT-13	13mm (1/2") Stud Cleaning Tool
402-00022	SBCT-22	22mm (7/8") Stud Cleaning Tool

STUD CLEANING KIT

KIT CONTAINS:

- SBCT22 with a SBR22 brush
- SBCT13 with a SBR13 brush
- Safety glasses
- 2 adapters
- 2 hex keys
- **REPLACEMENT BRUSHES:** SBR 12,13,14,16, 18, 20 and 22mm

Ascot No.	Mfg. No.	Description
402-01322	SKT-1322	Stud Cleaning Kit



402-01322
Stud Cleaning Kit

WHEEL & RIM DISMOUNTING TOOLS & ACCESSORIES



PROFESSIONAL STUD/HUB BRUSH KIT

- Ideal for hub and stud cleaning job with ease
- **QUICK AND EASY:** Change brushes in seconds
- Includes a 1/2" drive adapter
- Powered by a cordless drill
- **Truck and passenger**
- *Replacement brushes available*

KIT CONTAINS:

- (2) 14mm stud brushes
- (2) 22mm stud brushes
- (2) passenger hub brushes
- (2) truck hub brushes
- (1) plastic tool
- (1) adapter
- Blow molded case



Ascot No.	Mfg. No.	Description
402-32610	203610-ASC	Stud/Hub Brush Kit

402-32610
Stud/Hub Brush Kit - Truck/Passenger

***REPLACEMENT COMPONENTS FOR STUD/HUB BRUSH KIT**

Ascot No.	Mfg. No.	Description
402-32613	203613-ASC	4-Pack of Replacement 14mm Stud Brushes
402-32615	203615-ASC	4-Pack of Replacement Passenger Hub Brushes
402-32616	203616-ASC	4-Pack of Replacement Truck Hub Brushes



402-32613
4-Pack of Replacement 14mm Stud Brushes



REPLACEMENT BRUSHES FOR STUD/HUB BRUSH KIT

402-32615
4-Pack of Replacement Passenger Hub Brushes



WHEEL & RIM DISMOUNTING TOOLS & ACCESSORIES

MULTI-CLEANER TOOL KIT

- Universal cleaning tool
- Works great for brakes, exhaust, etc.

- Kit includes:**
- Multi-cleaner tool
 - 40mm x 110mm replacement pad
 - 50mm x 110mm replacement pad

Ascot No.	Mfg. No.	Description
402-46300	460 300	Multi-Cleaner Tool Kit
402-46340	460 340	40mm x 110mm Replacement Pads - 2-Pack
402-46350	460 350	50mm x 110mm Replacement Pads - 2-Pack



402-46300
Multi-Cleaner Tool Kit

WHEEL HUB GRINDER

- Special grinder for cleaning the wheel centering device as well as the attachment area between the wheel and hub
- Burnt-in corrosion residues are completely removed in a quick and easy process
- Actual cleaning time per hub only takes between 3-25 seconds depending upon residue thickness
- **Replacement Discs Available**

Ascot No.	Mfg. No.	Description
402-43352	433 502/M	Wheel Hub Grinder
402-43351	433 501	Grinder Replacement Discs (3 per package)



402-43352
Wheel Hub Grinder

402-43351
Grinder Replacement Discs

INNER RIM CLEANER AND REPLACEMENT DISCS

- Meant for the optimal cleaning of the inner wheel contact surface of an aluminum rim
- Prevents corrosion related distortion of wheel bolt tightening torque
- Allows for the complete removal of burnt-in corrosion
- Used only on the inside of an aluminum rim
- Velcro adhesive makes it easy to change out replacement discs
- 75 mm diameter
- **Replacement Discs Available (3 per box)**

Ascot No.	Mfg. No.	Description
402-43357	433 507	Inner Rim Cleaner
402-43358	433 508	Replacement Discs (3 per Box)



402-43357
Inner Rim Cleaner

402-43358
Replacement Discs



RPG HUB BUDDY TOOL

- **IMPACT RATED:** No need to change tools
- Complies with best practice R.I.S.T. procedure
- Removes rust, corrosion and other build-up from wheel stud, drums and tire rim
- Helps proper torque of lug nuts by removing corrosion
- **INCLUDES:** 1 Hub Buddy XL attachment and 1 cleaning disc head
- **Replacement cleaning discs available in packs of 6 (Product # 402-37335)**

Ascot No.	Mfg. No.	Description
402-37330	37330	RPG Hub Buddy Tool
402-37335	37335	RPG Hub Buddy Tool Replacement Pads
402-37340	37340	1-1/2" RPG Hub Buddy Tool Replacement Pads



402-37330
RPG Hub Buddy Tool

402-37335
RPG Hub Buddy Replacement Pads

HUB PRO XL

- Fits 1/2" Impact Wrenches
- Abrasive pads clean hubs
- Thread in replaceable pads
- Durable designs

Ascot No.	Mfg. No.	Description
402-00222	HBCTK-22	Hub Pro XL Tool (22mm) for Commercial/ Truck Use - Includes 5 Pads
402-00322	HBCR22	Hub Pro XL Replacement Pads - Pack of 6



402-00222
Hub Pro XL for Commercial/ Truck Use

402-00322
Hub Pro XL Replacement Pads



WHEEL & RIM DISMOUNTING TOOLS & ACCESSORIES

CHECKPOINT LOOSE WHEEL NUT INDICATORS

- A simple and cost effective product that can help guard against a potential catastrophic loss caused by loose lug nuts when used as part of a total torque wheel program
- When fitted on properly torqued wheel nuts and inspected by a driver or technician, the Checkpoints clearly and visually indicate if the wheel nuts have moved
- If the arrows have moved from the point-to-point pattern, this indicates that they have loosened and need attention
- Enhanced fleet safety management
- Facilitates the driver’s check for wheel nut movement and his involvement with vehicle safety
- Early warning for mechanic or driver of excessive heat caused by possible brake or bearing problems
- Demonstrate your fleet commitment to vehicle road worthiness and safety
- **QUANTITY:** 100 per bag

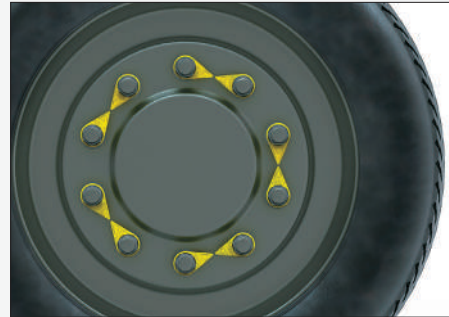

The Checkpoint Loose Wheel Nut Indicators in use.

Ascot No.	Mfg. No.	Description
402-20015	CPY38MM	Checkpoint 38mm (1-1/2") Fluorescent Yellow Loose Wheel Nut Indicator
402-20021	CPY21MM	Checkpoint 21mm Fluorescent Yellow Loose Wheel Nut Indicators
402-20030	CPY30MM	Checkpoint 30mm Fluorescent Yellow Loose Wheel Nut Indicator
402-20033	CPY33MM	Checkpoint 33mm Fluorescent Yellow Loose Wheel Nut Indicator
402-20078	CPY22MM	Checkpoint 22mm (7/8") Fluorescent Yellow Loose Wheel Nut Indicator
402-20114	CPY31MM	Checkpoint 31mm (1-1/4") Fluorescent Yellow Loose Wheel Nut Indicator
402-20233	CPOHT33MM	Checkpoint 33mm Orange High Temperature Loose Wheel Nut Indicator - 329°F melting point
402-20333	CPTR33MM	Checktorque 33mm Red Loose Wheel Nut Indicator (Re-torque after first 100 Miles)

**The use of Checkpoint Loose Wheel Nut Indicators does not guarantee wheel-offs will not occur.*



402-20021
Checkpoint 21mm Fluorescent Yellow Loose Wheel Nut Indicator

402-20233
Checkpoint 33mm Orange High Temperature Loose Wheel Nut Indicator

402-20333
Checktorque 33mm Red Loose Wheel Nut Indicator

DISCMATE WHEEL PROTECTORS

- Used to protect the wheel’s mounting surface from cosmetic damage during use
- Placed between the wheel and it’s mounting surface on the vehicle and may also be used between 2 dual wheels for added protection
- *Wheel nuts should always be tightened to the correct torque following the wheel manufacturer’s specifications*



DiscMate Wheel Protectors

Ascot No.	Mfg. No.	Description
402-11000	011000	10-Hole 285.75mm, Hub Pilot, 22mm Studs
402-16000	016000	10-Hole 11-1/4" Stud-Pilot, 3/4" Studs
402-17000	017000	10-Hole 11-1/4" Stud-Pilot, 1-1/8" Studs

WHEEL & RIM DISMOUNTING TOOLS & ACCESSORIES

HUBCAP PULLER/REPLACER

- Heavy duty construction
- Large rubber hammer designed to prevent damage
- Removes hub and dust caps easily

Ascot No.	Mfg. No.	Description
402-31568	75031	Hubcap Puller/Replacer

DROP CENTER TOOL

- Assists in mounting high performance tires by holding the bead in the drop center
- Will not scratch aluminum rims
- **EQUIVALENT TO COATS 435685**

Ascot No.	Mfg. No.	Description
402-72100	72100	Drop Center Tool - Tire Mounting Aid

HEAVY DUTY PROFESSIONAL CHROME NUT PULLER

- Coated to prevent scratching or damage to chrome, coated or painted lug covers
- Cushioned grip to prevent slippage
- **NO ADJUSTMENT REQUIRED:** fits all 33mm & 1½" covers
- **SIMILAR TO KEN TOOL 30606**
- **Made In Taiwan**

Ascot No.	Mfg. No.	Description
402-03016	202603	Heavy Duty Professional Chrome Nut Puller with Cushion Handle

COMMERCIAL TRUCK CHROME LUG NUT PULLER

- Thick carbon steel material provides strength for heavy duty applications
- Round shape handle provides comfort and ease of operation
- Suitable for all heavy duty truck lug nut applications
- Two hole design can be switched to expand range and size of application
- Coated jaws protect painted, aluminum or chrome plated lug nuts from damage
- **Made In Taiwan**

Ascot No.	Mfg. No.	Description
402-03116	202603-HD	Commercial Truck Chrome Lug Nut Puller

LUG NUT COVER WRENCH

- For use with Alcoa Hug-A-Lugs
- Black plastic
- Will work on all general lug nut cover kits
- 33mm hex
- 11" overall length
- Makes it simple to install or remove your covers by giving you a firm grip and a strong lever
- Similar to Alcoa 000600
- **Made in Taiwan**

Ascot No.	Mfg. No.	Description
402-06002	AS-3ALB	Lug Nut Cover Wrench



402-31568
Hubcap Puller/
Replacer



402-72100
Drop Center
Tool



402-03016
Heavy Duty
Chrome Nut
Puller



402-03116
Professional
Truck Chrome
Lug Nut Puller



402-06002
Lug Nut Cover
Wrench

WHEEL & RIM DISMOUNTING TOOLS & ACCESSORIES



319-00033
6 Pc. Inflatable Air Wedge Bag Kit



444-70202
Mag Tool Replacement Polymer Nose

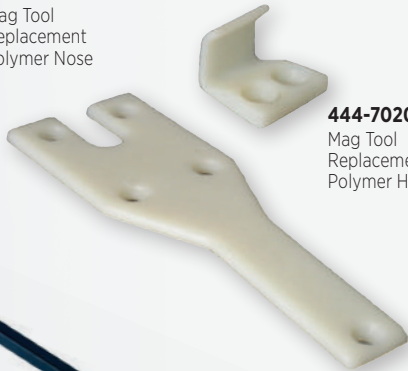

444-70204
Mag Tool Replacement Polymer Hook



NEW

319-76403
Professional 4 pc. Pry Bar Set



6 PC. INFLATABLE AIR WEDGE BAG KIT

- Contents : 6 PCS air wedge bag, 27.0 cm x 13.5 cm, 16.5 cm x 15.0 cm, 18.5 cm x 12.0 cm, 3 PCS Pry tool, 1 PCS Nylon bag
- Made of nylon material casted with double-sided TPU
- Will not damage, wear and contact the object surface
- Round corners, hard edges, smooth appearance, easy to insert to resist greater tension
- Squeeze pump to inflate
- Three sizes of inflatable cushion bags suitable for variety of applications
- **Made in China**

COMING SOON!
FALL 2024

Ascot No.	Mfg. No.	Description
319-00033	AS-3ALB	6 PC. Inflatable Air Wedge Bag Kit

MAG TOOL REPLACEMENT INSERT KIT

- Eliminates damage to mag, chrome & alloy wheels
- Fits all center-post tire changers
- Eliminates "booties" that slip off easily
- Inserts get 500-700 mounts/demounts if used correctly
- Inserts can be changed in seconds
- *Not for use on steel wheels*

Ascot No.	Mfg. No.	Description
444-70201	72010	Mag Tool Replacement Insert Kit
444-70202	72020	Mag Tool Replacement Polymer Nose - Only
444-70204	72040	Mag Tool Replacement Polymer Hook - Only

PROFESSIONAL 4 PC. PRY BAR SET

- Chrome vanadium steel shafts x 24" pry bars
- Injection molded handle
- Black oxide finish resists corrosion
- Curved blades
- Includes ¼" x 8", 3/8" x 12", 7/16" x 18" & 7/16" x 24"
- Includes handy storage tray
- **Made in Taiwan**



Ascot No.	Mfg. No.	Description
319-76403	AS-876404	Professional 4 Pc. Pry Bar Set

BEAD BREAKERS & BEAD SEATING DEVICES

HANDLE PROTECTOR

- Made of a durable synthetic rubber
- Fits multiple jack manufacturers' handles and popular tire tools
- Protects vehicles from scratches or dents caused by falling jack handles and unstable tools in the shop
- Unique design ensures a tight fit on jack/tool handle without slippage
- Patent Pending design absorbs the dent/scratch-causing force as the handle contacts an adjacent vehicle

Ascot No.	Mfg. No.	Description
448-01101	GHP-01	Black Handle Protector
448-01102	GHP-01-Y	Yellow Handle Protector

448-01101
Black Handle Protector



448-01102
Yellow Handle Protector

YELLOW RUBBER COATED BEADKEEPER

- Keeps truck tire bead from slipping during mounting of top bead
- Rubber coated steel construction
- Will not scratch aluminum wheels
- Great for hard to mount tires, a must for all super singles

Ascot No.	Mfg. No.	Description
448-12894	12894C	Yellow Rubber Coated Beadkeeper



448-12894
Yellow Rubber Coated Beadkeeper



BLUE WIDE MOUTH RUBBER COATED BEADKEEPER

- Wider mouth works on newer, wider Alcoa wheels
- Keeps truck tire bead from slipping during mounting of top bead
- Rubber coated steel construction
- Will not scratch aluminum wheels
- Great for hard to mount tires, a must for all super singles

Ascot No.	Mfg. No.	Description
448-32894	12894-CW	Wide Mouth Blue Rubber Coated Beadkeeper

448-32894
Wide Mouth Blue Rubber Coated Beadkeeper



STEEL BEADKEEPER

THE ORIGINAL BEADKEEPER®

- Used to hold a tire bead in place during the mounting process
- Eliminates the need to stand on the tire and/or use a second mounting bar

Ascot No.	Mfg. No.	Description
448-22894	12894	Steel Beadkeeper

448-22894
Steel Beadkeeper



STEEL TRUCK BEAD HOLDER

- Clamps securely to the wheel to prevent tire from "walking"
- Eliminates the use of vise grips which can damage wheels
- For use with automatic tire changers and/or manual tire changing tools
- Heavy duty steel construction

Ascot No.	Mfg. No.	Description
448-00010	BJ-BP10	Steel Truck Bead Holder



448-00010
Steel Truck Bead Holder



BEAD BREAKERS & BEAD SEATING DEVICES



421-03842
Ascot Manual
Bead Breaker

ASCOT MANUAL BEAD BREAKER

- Handles 38" and 42" 14-ply farm tractor and backhoe tires with drop center rims to small ATV and lawn mower tires
- Newly improved bead hook, reinforced with steel bracket to create better leverage and add dexterity
- Loosens tire bead from rim with leverage
- Excellent for working on the tire without removing the wheel
- Do not use impact tools
- Weight: 9.4 lbs.

Ascot No.	Mfg. No.	Description
421-03842	MBB38-42	Ascot Manual Bead Breaker



427-01322
Martins Slide
Hammer Bead
Breaker

MARTINS SLIDE HAMMER BEAD BREAKER

- Channel your strength into a single impact to efficiently break tire beads
- The fastest of all manual bead breaker tools
- Efficient & uncomplicated to operate
- Suited for truck tires of a variety of sizes and widths
- Curved tip slides itself perfectly between bead and rim flange, preventing damage on impact
- Made of carbon steel, set to become one of the longest-lasting tools in the shop
- **Made in China**

Ascot No.	Mfg. No.	Description
427-01322	MBB	Martins Slide Hammer Bead Breaker



469-32011
Ken Tool Valve
Breaker Tool

KEN TOOL VALVE BREAKER TOOL

- Made in the USA
- Quality, high-grade steel
- Heat-treated punch for top performance and long life.
- Pinch-preventing Safety Grip with vibration dampening tube grip
- Long-lasting baked powder coat finish
- designed to fit into most 30" toolboxes

Ascot No.	Mfg. No.	Description
469-32011	35936	Ken Tool Valve Breaker Tool

BEAD BREAKERS & BEAD SEATING DEVICES

VALVE BLASTER TRUCK VALVE STEM REMOVAL TOOL

- Removes valves quickly
- Slide hammer with an internal spring absorbs the shock of impact
- Designed to shear the bottom flange off the valve with one or two blows
- 63" overall length

Ascot No.	Mfg. No.	Description
469-22011	VB	Valve Blaster Truck Valve Stem Removal Tool

469-22011
Valve Blaster
Truck Valve Stem
Removal Tool

UNIVERSAL IMPACT DRIVEN DEMOUNT TOOL

- Safe, simple, fast, economical and the most universal tire demounter on the market
- Works as a hand-held tire machine and shines where other tools fall short
- Comes with 1-1/16" socket
- Tackles the hard 19.5" reverse hubs and grader tires and can be used on all tire sizes from 10" ATV tires and up
- Great for agricultural tires, one-piece grader, loader, forestry and backhoe tires



Ascot No.	Mfg. No.	Description
402-20408	20408	Universal Impact Driven Demount Tool

402-20408
Universal
Impact Driven
Demount Tool

GOLDEN BUDDY TIRE CHANGING SYSTEM

- Mount and demount tool assemblies for 22.5 & 24.5 tires/wheels
- Heavy duty steel construction
- Nylon rollers protect the bead
- **WEIGHT:** 32 lb. (14.5 kg)

Ascot No.	Mfg. No.	Description
448-12320	71050	Golden Buddy Tire Mount/Demount Tool Set
448-22320	71051	Golden Buddy Dismount Assembly
448-32320	71052	Golden Buddy Mount Tool Assembly

448-32320
Golden
Buddy
Mount Tool
Assembly

448-22320
Golden
Buddy
Dismount
Assembly



BEAD BREAKERS & BEAD SEATING DEVICES

448-93500
OTR EM Rim
Flange Clamp

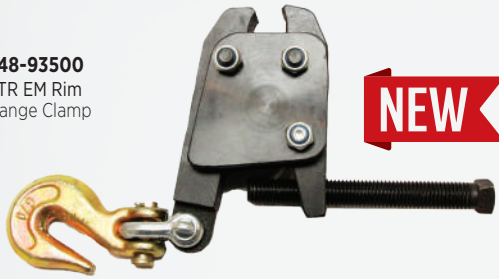

OTR EM RIM FLANGE CLAMP

- Clamps to bead seat band to assist in seating for inflation during tire service
- Used to assist in removal of bead seat band
- Sold individually but frequently used in pairs

Ascot No.	Mfg. No.	Description
448-93500	93500	OTR EM Rim Flange Clamp

O-RINGS FOR TUBELESS RIMS

- Made of high quality polysoprene rubber
- Packaged 2 per poly bag, 24 O-rings per case
- Manufactured to major OEM specifications
- **Made In USA**

Ascot No.	Mfg. No.	Rod Diam.	Size
471-80008	OR-25-T	0.26"	EM 25"
471-80007	OR-224-TG	0.26"	Grader 24"
471-80012	OR-333-T	0.385"	EM 33"
471-80010	OR-325-T	0.385"	EM 25"
471-80018	OR-25-TA	0.26" Arctic	EM 25"
471-80017	OR-224-TGA	0.26" Arctic	Grader 24"
471-80112	OR-333-TA	0.385" Arctic	EM 33"
471-80110	OR-325-TA	0.385" Arctic	EM 25"



422-11000
OTR Giant Tire
Bead Breaker



OTR GIANT TIRE BEAD BREAKER

- Most popular tool for breaking beads on earthmover tires, sizes 25"-51" with bead loosening pockets
- Works only on 5-piece wheels
- 13.8 tons of hydraulic force
- Will break the toughest beads

Ascot No.	Mfg. No.	Description
422-11000	11000	OTR Giant Tire Bead Breaker



"COMBI" TIRE BEAD BREAKER

- Most popular tool for breaking beads on all agricultural wheels
- Used on construction wheels up to 25"
- Works on single, 2, and 3-piece wheels Breaks beads in seconds using 10,000 lb. of force
- No screws, bolts or attachments
- Will not work on five-piece earthmover giant wheel/rim

Ascot No.	Mfg. No.	Description
422-11010	11010	"Combi" Tire Bead Breaker

TITAN MODIFIED "COMBI" BEAD BREAKER

- Compact design allows tool to be used on front or back of wheel
- Ideal to break large OTR 3-piece wheels
- Larger clamp and feet allow tool to easily clamp onto wheels
- Most parts interchange with common bead breakers in the market
- Designed for use on 25" multi-piece wheels
- Tire Sizes: 23.5x25, 26.5x25, 29.5x25
- 11 Ton - 10,000 PSI (700 BAR)

Ascot No.	Mfg. No.	Description
422-11025	11025	Titan Modified "Combi" Bead Breaker



422-11025
Titan "Combi"
Bead Breaker

BEAD BREAKERS & BEAD SEATING DEVICES

DUAL AGRICULTURAL BEAD BREAKER

- To be used on dual agricultural tires to break inside bead on outside tires, eliminating the need to remove the tire off of dual farm tractors
- Lightweight and easy to use
- Fitted with removable handle for easier maneuvering and positioning of the bead breaker onto tire bead
- 10,000 lbs. of pushing force
- Break inner bead with as little as 4-1/2" of operating space
- Capable of extending 12 inches wide
- Used with hydraulic pump, hose and other accessories



422-10165
Dual Agricultural Bead Breaker

Ascot No.	Mfg. No.	Description
422-10165	10165	Dual Agricultural Bead Breaker

DIAMONDBACK ALUMINUM BEAD BREAKER KIT

- Lightweight Aluminum reduces weight by 40%
- Longer feet allow better fit onto wheel/rim
- Feet fully engage rim flange and push against the bead of the tire
- **WEIGHT:** 31 lb. (14kg)

The AME 11076 includes a clamping jaw pivot pin which can be placed in one of four jaw pivot positions for use on different width flanges. The top hole (closest to the handle) is used for smaller rim flanges, and the bottom hole (furthest from the handle) is used for larger rim flanges.



The Diamondback Aluminum Bead Breaker in use.

422-11076
Diamondback Aluminum Bead Breaker Kit

Ascot No.	Mfg. No.	Description
422-11076	11076	Diamondback Aluminum Bead Breaker Kit

TIRE BEAD BREAKING HAMMERS

- A unique tire & wheel service hammer used for separating tires from wheel rims
- Patented heat treatment process ensures uniform hardness on all faces including edges, thus preventing mushrooming of head & accidents due to chipping
- Ergonomic rubber grip handle absorbs vibrations & reduces fatigue
- Head is induction case hardened for extended life
- 5 lb. & 10 lb. hammers available
- **Made in India**

COMING SOON!
FALL 2024

429-10005
5lb. Bead Breaker Hammer

429-10010
10 lb. Bead Breaker Hammer

Ascot No.	Mfg. No.	Description
429-10005	AS-BBH5	5 lb. Bead Breaker Hammer
429-10010	AS-BBH10	10 lb. Bead Breaker Hammer

PORTABLE TIRE PRESS

- Portable tire press for use with industrial tires
- Originally designed for use with Michelin Tubeless bead seal
- Useful for multipiece industrial tire assembly
- Includes plates for 8", 10" and 12" applications
- Weight: 46.5 lbs.

NEW

421-71750
Portable Tire Press

Ascot No.	Mfg. No.	Description
421-71750	71750	Portable Tire Press



BEAD BREAKERS & BEAD SEATING DEVICES

FIBERGLASS REPLACEMENT HANDLE

Ascot No.	Mfg. No.	Description
429-35832	TG11EH	32" Fiberglass Replacement Handle

429-35832
32" Fiberglass Replacement Handle

32" FIBERGLASS REPLACEMENT HAMMER HANDLE

- Handles are constructed with a solid core which has thousands of fiberglass strands
- Unique resin makes it super strong
- All-weather, chemical and insect-resistant
- Ergonomic non-slip grips for slippery conditions
- Replacement adapters available

Ascot No.	Mfg. No.	Description
429-32344	AS-32FGH	32" Fiberglass Replacement Hammer Handle

COMING SOON!
WINTER 2024

429-32344
32" Fiberglass Replacement Handle

WATER ADAPTER SET

- Permits fast filling of tires with fluid for ballast
- Includes extra bushings for standard bore tire valves and old 9251-type valves
- Button valve on side releases air displaced by fluid
- Hose connection is 3/4" standard garden hose

Ascot No.	Mfg. No.	Description
464-92837	WA-1	Water Adapter Set

464-92837
Water Adapter Set

DOUBLE DIAPHRAGM CALCIUM CHLORIDE PUMP

- No lubrication required
- Self-priming, non-stalling, low noise level
- Diaphragms have no stress points and less flex for longer life
- No gradual loss of pump performance due to wear
- Can run dry indefinitely
- Protected by an air filter/regulator
- 35 gallon per minute free flow
- Parts & accessories also available from AME



475-15103
Double Diaphragm Calcium Chloride Pump

Ascot No.	Mfg. No.	Description
475-15103	15103	Double Diaphragm Calcium Chloride Pump
475-30280	A3028	Replacement 4-Way Valve for Calcium Chloride Pump
475-30281	HL-B	Replacement Handle for Calcium Chloride Pump 4-Way Valve

475-30280
Replacement 4-Way Valve

475-30281
Replacement Handle



THANK YOU ON BEHALF OF EVERYONE AT ESCO FOR **40 SUCCESSFUL YEARS OF PARTNERSHIP AND COMMITMENT TO THE TIRE AND WHEEL MARKET!**



UNIVERSAL IMPACT DRIVEN DEMOUNT TOOL

model 20408

SAFE, SIMPLE, FAST, ECONOMICAL, AND THE MOST UNIVERSAL TIRE DEMOUNTER ON THE MARKET. > Works as a Hand-Held Tire Machine and shines where other tools fall short. > Tackles the Hard 19.5 Reverse Hubs and Grader Tires and can be used on ALL Tire sizes from 10" ATV Tires and Up. > Great for Agricultural Tires, One-Piece Grader, Loader, Forestry and Back Hoe Tires. > Comes with 1 1/16" Socket.



DESIGNED FOR HD
Patented Designed Bead Grasping Heel. Great For Agricultural Tires, One-Piece Grader, Loader, Forestry, & Back Hoe Tires.



USE WITH IMPACT GUN
1 1/16 Inch Pneumatic Drive, Drives Demounter Tool. Use Impact Gun (Air or Battery Operated)



UNIVERSAL DESIGN
Can be Used on All Tire Sizes from 10 in. ATV Tires and up to some grader tires.



1/2 GALLON PUMP > 10-TON STAK-ABLE RAM > DUAL AG. BEAD BREAKER



A MODEL 10518 1/2 GALLON AIR HYDRAULIC PUMP

Equipped with an air exhaust muffler for quiet pumping of the air motor. > Air and oil inlet filters for reducing the risk of contamination. > Durable, lightweight design great for service trucks, shop environments, or out in the field. > Internal pressure relief valve system (load limit device) for overload protection. > Engineered with a durable lightweight and corrosive resistant plastic components. – increasing the life of the air motor and hydraulic pump.

B MODEL 10316 10 TON STAK-ABLE RAM KIT

Great for use in multiple applications in the tire/wheel service market. > Ideal for low clearance applications. > Easy snap-in extensions. > Made of high-quality steel. > Most versatile 10 Ton Ram on the market. > Easy to switch out extensions length. > Includes Carrying Case.

C MODEL 10165 DUAL AGRICULTURAL BEAD BREAKER

Used on dual-agricultural tires to break inside bead on outside tires, eliminating the need to remove from tractor. > Removable handle for easier positioning. > Lightweight and easy to use. > Break inner bead with as little as 4 1/2 inches of operating space. > 10,000 lbs of hydraulic pushing force.

ESCO
ALL AROUND THE WHEEL...AND SO MUCH MORE



BEAD BREAKERS & BEAD SEATING DEVICES



422-94549
Dual Wheel Separator

DUAL WHEEL SEPARATOR

- Makes removing stuck or frozen dual steel wheels quick and easy
- Ideal for use on nearly any truck, bus, van or trailer that has dual steel wheels
- Innovative “one-piece” pusher won’t fall apart during use
- Forcing screw and pullers have powerful 1-1/8” diameter x 7 threads for years of reliable service
- Pusher is ball bearing-driven for near-zero turning resistance
- Pusher is heat treated for long-lasting strength and durability
- *Includes two pullers to cover large truck, trailer and smaller light truck dual wheel applications*
- *Use with air or electric impact wrench*
- Blow molded case
- **Made in Taiwan**

Ascot No.	Mfg. No.	Description
422-94549	ASC94549	Dual Wheel Separator



318-11518
Kit with Hose, Coupler & Reducer

1/2-GALLON AIR/HYDRAULIC PUMP - ALUMINUM RESERVOIR

- For use with a variety of hydraulic rams, cylinders, presses, bead breakers, and other hydraulic equipment requiring 10,000 psi for operation
- Equipped with an air exhaust muffler for quiet pumping of air motor
- Air and oil inlet filters for reducing risk of damage from contamination
- Durable, lightweight design great for service trucks, shop environments or out in the field
- Internal pressure relief valve system (load limit device) for overload protection
- Engineered with durable lightweight and corrosive resistant plastic components, increasing the life of the air motor and hydraulic pump



Ascot No.	Mfg. No.	Description
318-11518	10518C	1/2-Gallon Air/Hydraulic Pump Kit INCLUDES Hose, Coupler & Reducer
318-10518	10518	1/2-Gallon Air/Hydraulic Pump

318-15905
2-1/2-Quart Titan Air/Hydraulic Pump, 10,000 PSI



2.5-QUART TITAN AIR/HYDRAULIC PUMP - ALUMINUM RESERVOIR

- Operates with as little as 80 PSI (5.5 bar)
- Heavy duty aluminum reservoir
- Durable metal air motor
- **WEIGHT:** 14 lb. (6.4 kg)

Ascot No.	Mfg. No.	Description
318-15905	15905	2-1/2-Quart Titan Air/Hydraulic Pump, 10,000 PSI

BEAD BREAKERS & BEAD SEATING DEVICES



RPG 5-GALLON BEAD SEATERS

- 5-gallon capacity
- Equipped with a butterfly valve for maximum air discharge
- Designed for commercial use on large truck tires, passenger and ATV tires to 24.5"
- Rubber foot pads to lessen vibration
- **Similar to Cheetah CH-5, CH-5AL, BS-07**
- **Made in Taiwan**



473-01500
RPG 5-Gallon Bead Seater

Ascot No.	Mfg. No.	Description
473-01500	RPG-05GAL	5-Gallon Bead Seater with Butterfly Valve
473-02505	RPG-05GALED	5-Gallon Bead Seater with Butterfly Valve - End Discharge
473-02501	RPG-05GALAL	5-Gallon Bead Seater with Butterfly Valve - ALUMINUM

Includes easy carry handle for portability

Features a 5-gallon capacity tank

Quick-release 1-1/2" butterfly valve allows for full impact of air discharge into tire

Lip on threaded barrel allows for proper angle for air insertion for correct bead seating



1/4" air inlet shutoff valve allows for filling the correct amount of air for the size of tire being seated

Pneumatic gauge makes it easy to fill the correct amount of air for the size of tire being seated



473-02505
RPG 5-Gallon Bead Seater with Butterfly Valve - End Discharge

BEAD BREAKERS & BEAD SEATING DEVICES



RPG 10-GALLON BEAD SEATERS

- 10-gallon capacity
- Equipped with a butterfly valve for maximum air discharge
- Designed for commercial use on large truck tires, passenger and ATV tires to 24.5"
- **Similar to Cheetah CH-10, CH-10AL**
- **Made in Taiwan**



473-02510
RPG 10-Gallon Bead Seater with Butterfly Valve

Ascot No.	Mfg. No.	Description
473-02510	RPG-10GAL	10-Gallon Bead Seater with Butterfly Valve
473-02511	RPG-10GALAL	10-Gallon Bead Seater with Butterfly Valve - ALUMINUM

RPG 13-GALLON BEAD SEATER

- Aluminum tank
- 10-gallon capacity
- Equipped with a butterfly valve for maximum air discharge
- Designed for commercial large truck tires 24" to 54"
- **Similar to Cheetah CH-13**
- **Made in Taiwan**



473-02513
RPG 13-Gallon Aluminum Bead Seater with Butterfly Valve

Ascot No.	Mfg. No.	Description
473-02513	RPG-13GALAL	13-Gallon Bead Seater with Butterfly Valve - ALUMINUM



RPG BEAD SEATER PARTS & ACCESSORIES

Ascot No.	Mfg. No.	Description
473-01502	RPG-05GAL-02	Safety Valve for RPG Bead Seater
473-01504	RPG-05GAL-04	Butterfly Valve for RPG Bead Seater
473-01506	RPG-05GAL-06	Air Pressure Gauge for RPG Bead Seater
473-01509	RPG-05GAL-09	90° NPT Elbow for RPG Bead Seater

Ascot No.	Mfg. No.	Description
473-01510	RPG-05GAL-10	Ball Valve for RPG Bead Seater
473-01516	RPG-10GAL-16	2" Butterfly Valve for RPG Bead Seater
473-01518	RPG-05GALED-01	Threaded Barrel for RPG End Discharge Bead Seater

BEAD BREAKERS & BEAD SEATING DEVICES



5-GALLON CHEETAH BEAD SEATERS

- Makes seating the most difficult bead safe and simple
- Fill tank from any service station chuck or service truck air compressor
- **APPLICATIONS:** Designed for commercial use on large truck tires, passenger and ATV tires to 24.5"
- 5-gallon capacity

Ascot No.	Mfg. No.	Description
473-00500	CH-5	5-Gallon Cheetah Bead Seater
473-00501	CH-5AL	5-Gallon With Aluminum Tank

10-GALLON CHEETAH BEAD SEATERS

- **APPLICATIONS:** Designed for small rear agri/grader or smaller tires; Standard for fleet work, farm and service trucks
- 10-gallon capacity with ASME certified tank

Ascot No.	Mfg. No.	Description
473-00010	CH-10	10-Gallon Cheetah Bead Seater
473-00011	CH-10AL	10-Gallon With Aluminum Tank

13-GALLON CHEETAH BEAD SEATER

- **APPLICATIONS:** Seats bead on tractor & heavy equipment tires from 24.5" to 54"
- Extends tire service capability not possible with portable unit
- 13-gallon capacity, ASME certified tank
- **INCLUDES:** A straight barrel, new Magnum barrel (for larger tires) and safety goggles as standard equipment

Ascot No.	Mfg. No.	Description
473-00013	CH-13AL	13-Gallon Cheetah Bead Seater With Aluminum Tank

BS-07 CHEETAH BEAD SEATER

- "End of Tank" discharge design, flared discharge barrel and a 2" discharge valve for maximum bead seating power
- Makes seating the most difficult bead not only safe but simple, fast and economical
- 5-gallon capacity, ASME certified tank
- Equipped with TSE's patented discharge system
- **SIZE:** 34"(L) x 12"(W) x 15"(H)

Ascot No.	Mfg. No.	Description
473-00207	BS-07	BS-07 Cheetah Bead Seater



473-00500
5-Gallon Cheetah Bead Seater



473-00010
10-Gallon Cheetah Bead Seater

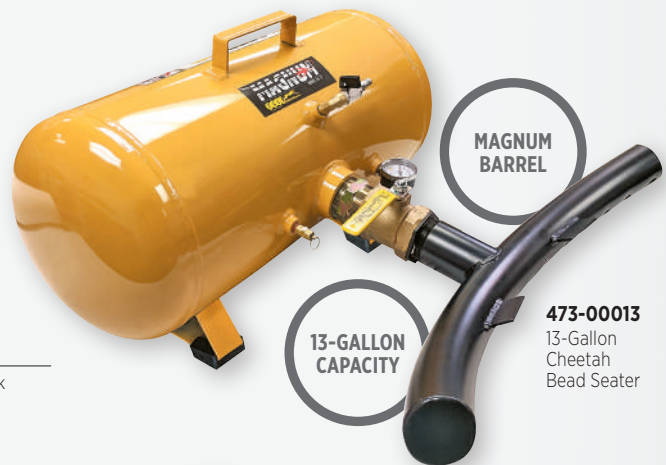

473-00013
13-Gallon Cheetah Bead Seater



473-00207
BS-07 Cheetah Bead Seater

BEAD BREAKERS & BEAD SEATING DEVICES

CHEETAH BEAD SEATER REPLACEMENT PARTS

Ascot No.	Mfg. No.	Description	Ascot No.	Mfg. No.	Description	Ascot No.	Mfg. No.	Description
473-01104	'01.104	1-1/2" Pipe Nipple for Cheetah Bead Seaters	473-02103	'02.103	1-1/2" Threaded Barrel for Cheetah Bead Seaters	473-03104	'03.104	90° NPT for Cheetah Bead Seaters
473-01106	'01.106	Pressure Gauge for Cheetah Bead Seaters	473-02106	'02.106	Magnum I Barrel for Cheetah Bead Seaters	473-03106	'03.106	Magnum II Barrel for Cheetah Bead Seaters
473-01107	'01.107	3/4" - 1/4" Bushing for Cheetah Bead Seaters	473-02107	'02.107	1-1/2" Lock Nut for Cheetah Bead Seaters	473-04103	'04.103	Ball Valve for Cheetah Bead Seaters
473-01230	'01.230BT	Handle & Nut for Butterfly Valve for Cheetah Bead Seaters	473-03102	'03.102	2" Discharge Valve for Cheetah Bead Seaters	473-05102	'05.102	Safety Release Valve for Cheetah Bead Seaters
473-02102	'02.102	1-1/2" Discharge Valve for Cheetah Bead Seaters	473-03103	'03.103	2" Barrel for Cheetah Bead Seaters	473-06813	'6813	Flared Barrel for BS-07 for Cheetah Bead Seaters



473-01106



473-02103



473-02102



473-03102



473-01502



473-03104



473-04103

JET PAK BEAD SEATER UPGRADE DEVICE

- Faster and easier than standard ball or butterfly discharge valve operation
- Discharges tank with the press of a button
- Safety cover prevents accidental trigger release
- Two port sizes available: CH1.5JP (1.5") and CH2.0JP (2") to fit any standard bead seater in a variety of tank sizes
- Attaches easily to existing pipe nipple, replacing manual discharge valve
- Includes our new improved Jet Barrel (VP 3.103 or VP 2.103) for greater air volume delivery
- Comfortable handle assures firm grip and ease of use
- All internal components can be removed and serviced if required



473-00015

Ascot No.	Mfg. No.	Description
473-00015	CH-1.5JP	Jet Pak Bead Seater Upgrade Device - 1.5" Port Size

VIPER™ BEAD SEATERS

- Push button discharge
- Unique handle design for stability and control
- ASME Certified
- Rapid release of air
- Newly designed jet barrel for greatly increased air volume delivery
- More power less air pressure
- Reduces air noise
- Greater air distribution
- No wheel damage
- Works on large range of tires



473-01113

473-01110

473-01118

Ascot No.	Mfg. No.	Description
473-01113	VP 13AL	Viper™ 13 Liter Bead Seater, Aluminum Tank
473-01110	VP 10S	Viper™ 11.5 Liter Bead Seater, Steel Tank
473-01118	VP 18AL	Viper™ 18 Liter Bead Seater, Aluminum Tank



*Please note we recommend the use of a good quality inline filter to remove contaminants and moisture.
*Please note we recommend the use of silicone spray or air tool oil occasionally to properly maintain the valve.

BEAD BREAKERS & BEAD SEATING DEVICES



BEAD BAZOOKA®

- Smaller and more powerful than previous designs
- Serviceable/Replaceable 2" RAR valve
- Utilizes ultra-compact design
- Anti-corrosion interior tank coating
- Perfect for motorcycle, cars, or light commercial vehicle tire service (3L2)
- Perfect for cars and commercial vehicle tire service (6L2)
- Perfect for commercial and light agricultural vehicle tire service (10L2)
- Made in Taiwan



Ascot No.	Mfg. No.	Description	Weight	Dimensions	Inner Diameter
473-00103	GBB3L2	Bead Bazooka 3L2	14 lbs.	23" x 6" x 12"	4 in.
473-00106	GBB6L2	Bead Bazooka 6L2	15 lbs.	23" x 7" x 12"	4.75 in.
473-00110	GBB10L2	Bead Bazooka 10L2	18 lbs.	30" x 7" x 12"	5.5 in.



BEAD BAZOOKA® SPARE PARTS:

Ascot No.	Mfg. No.	Description
473-12913	12913B	Slotted Double Barrel
473-12914	12914B	Pressure Gauge
473-12915	12915B	Y-Connect
473-12916	12916B	Intake Valve
473-12917	12917B	Safety Valve
473-12919	12919B	Switch Valve
473-12920	12920B	Grip with Trigger Guard
473-12923	12913BC	Slotted Double Barrel without Clip
473-12930	12930M	F3 Connector



BEAD BAZOOKA® REPAIR KIT

- Kit lets the user repair/replace the piston/valve of the Bead Bazooka®
- Intended to extend the lifespan of the Bead Bazooka® by making the Bead Bazooka® fully serviceable
- Saves the user precious time because the repairs can be done quickly and effectively in-house
- Only compatible with second generation Bead Bazooka® models (BB3L2, BB6L2, BB10L2)

KIT CONTENTS:

- Piston
- O-ring
- Lock ring key
- Spring



Ascot No.	Mfg. No.	Description
473-22181	GBBVRK	Bead Bazooka Repair Kit

TIRE CHANGER ACCESSORIES



444-01226



444-01230



444-01228



444-01222



444-01224



'WING' MOUNT/DEMOUNT HEAD

- For use with Hunter tire changer
- Molded wing guides the tire bead into the drop center
- Prevents the tire from moving above the knuckle
- Faster and easier mounting process

Ascot No.	Mfg. No.	Description
444-01226	8-11400327	'Wing' Mount/Demount Head

NYLON MOUNT/DEMOUNT HEAD ONLY

- Replacement For Accuturn 20024335
- Use With Models 7700, 8910, 8911, 8922, 8944, and 8989
- Replacement For Hofmann 20024335
- Replacement For FMC/ John Bean EAA 24335
- For Use On EHP Series Tire Changers
- Replacement For Snap-On 24335. For Use On All Models
- Head Only

Ascot No.	Mfg. No.	Description
444-01228	TC20024335	Nylon Mount/Demount Head Only

NYLON TOOL HEAD FOR HUNTER TIRE CHANGERS

- For Use On TCA34 With Serial Number 664 And Above
- Tool Head For Hunter TCA34 Tire Changers

Ascot No.	Mfg. No.	Description
444-01230	TC14120	Nylon Tool Head for Hunter Tire Changers

NYLON MOUNT/DEMOUNT HEAD FOR COATS, CORGHI & HUNTER TIRE CHANGERS

OEM	Part Number	Tire Changer
All Tool	G3008403	All models
Coats	83008403	RC1, 5, 10, 15, 20 Early 5060, 9010, 9024, APX90
Corghi	450310	All rim clamp (optional accessory)
Giuliano	3008403	Shaft must be turned 180° for this head to work
Hofmann	8314813	All earlier models except 1550, 1620, 1625
Hunter	RP11-8314813	TCX Series (RP11-5-400-100 Adapter required) TCX500 Requires Upgrade Shaft & Adapter Kit
Sice	8314813	M39, S40, S41, S42, S43, S45, S408MAXI, S435, S436, S436TOP

Ascot No.	Mfg. No.	Description
444-01222	TC450310	Nylon Mount/Demount Head for Coats, Corghi & Hunter Tire Changers

RED PLASTIC HUNTER MOUNT/DEMOUNT HEAD

Larger channel for difficult wheels • Specifically designed for low profile tires For Hunter TCA34 tire changers • Application chart below:

OEM	Part Number	Tire Changer
Hunter	221-675-2	TC250, TC300, TC325, TC350, TC2000, TC3250, TC3500
	221-675-2-B	TC250, TC300, TC325, TC350, TC2000, TC3250, TC3500

Ascot No.	Mfg. No.	Description
444-01224	TCR343	Red Plastic Hunter Mount/Demount Head

TIRE CHANGER ACCESSORIES

NYLON MOUNT/DEMOUNT HEAD, COATS & HUNTER STYLES

Ascot No.	Mfg. No.	Description
444-01220	TC183061-A	Nylon Mount/Demount Head (Coats Style)
444-01221	VT-1221	Nylon Mount/Demount Head (Hunter Style)



444-01220



444-01221



GREY NYLON MOUNT/DEMOUNT HEAD

- Grey nylon mount/demount head kit for low profile tires
- Use with difficult wheels
- COMPATIBLE WITH COATS TIRE CHANGERS: 5030, 5040, 5050, 5060, 5065, 6050, 6060, 6065, 7050, 7055, 7060, 7065, 7655, 7660, 7665

Ascot No.	Mfg. No.	Description
444-01223	TC184432	Grey Nylon Duckhead Kit for Coats Tire Changers

444-01223



444-01225



STAINLESS STEEL MOUNT/DEMOUNT HEAD FOR COATS TIRE CHANGERS

- Tapered stainless steel mount/demount head used on many Coats tire changers
- For steel wheels and high-volume shops dealing mostly with OEM passenger cars and light trucks
- FOUND ON COATS MODELS: 5030, 5040, 5045, 5050, 5060, 5065, 5070, 6050, 6060, 6065, 7050, 7055, 7060, 7065, 7655, 7660, 7665, 70XE1, 70XE2, 70XE3
- Includes the set screws for adjusting the angle

Ascot No.	Mfg. No.	Description
444-01225	TC182788	Stainless Steel Duckhead for Coats Tire Changers

PLASTIC RIM PROTECTORS FOR COATS STAINLESS STEEL MOUNT/DEMOUNT HEADS

- Designed for COATS stainless steel mount/demount heads
- Made from a durable plastic material to prevent marring or scratching
- Available in packs of 2 or 12

Ascot No.	Mfg. No.	Description
444-82961	TI182961	2-Pack of Plastic Rim Protectors for Coats Stainless Steel Mount/Demount Head
444-82963	TI182963	12-Pack of Plastic Rim Protectors for Coats Stainless Steel Mount/Demount Head

444-82961,
444-82963

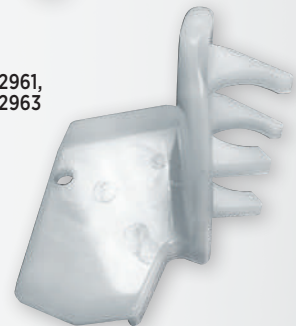

GRIP-MAX INSERTS

- Replacement grips for Coats Grip-Max jaws
- 2 inserts required per jaw
- OE# 500059408
- 8 per pack



Ascot No.	Mfg. No.	Description
444-59408	AE5009408	Grip-Max Inserts

444-59408



TIRE CHANGER ACCESSORIES

COMING SOON!
FALL 2024

444-23614
23.6" Bead Lifting Tool



444-81354
Rim Clamp Bead Lifting Tool

23.6" BEAD LIFTING TOOL W/ ENHANCED GRIP

- Enhanced angle allows more efficient grip of the tire
- Made of steel
- Avoids scratching aluminum rims
- Decreases the possibility of breaking a bead
- Deep grooves to provide extra grip and avoid slippage
- 23.6" overall length
- **Made in Taiwan**

Ascot No.	Mfg. No.	Description
444-23614	TC181354	23.6" Bead Lifting Tool w/ Enhanced Grip

RIM CLAMP BEAD LIFTING TOOL

- Designed for ease of lifting the bead during the tire changing operation
- 20" overall length
- Made from a durable chrome-vanadium material
- **Equivalent to COATS 181354**

Ascot No.	Mfg. No.	Description
444-81354	TC181354	Rim Clamp Bead Lifting Tool

LONG SOCK FOR BEAD LIFTING TOOL

- High quality plastic sleeve prevents the rim from scratching while lifting the bead
- Made from high quality, durable nylon
- Ribbed design for anti-slip contact
- 4-Pack

Ascot No.	Mfg. No.	Description
444-22019	220019	Long Sock for Bead Lifting Tool - 4 Pack

LOW PROFILE BEAD LEVER TOOL

- Angled design and extra-long length provide increased leverage
- Super-grip knurled handle for increased grip
- Durable high strength carbon steel construction
- Reduces strain on user's hand and wrist
- Provides technician better control of the tool against stiff sidewalls
- Helps prevent damage to expensive wheels

Ascot No.	Mfg. No.	Description
444-99719	99719	Low Profile Bead Lever Tool

MISCELLANEOUS TIRE SWABS AND BRUSHES

Ascot No.	Mfg. No.	Description
437-00001	TS-1	Tire Swab: 11" OAL X 2" Diameter
437-00002	TS-2	Tire Swab: 15" OAL X 2" Diameter
437-00003	TS-3	Tire Swab: 18" OAL X 3" Diameter
437-13014	313014	Hunter-Style Tire Lubricating Brush

FLANGE MOUNT AIR GAUGE FOR COATS TIRE CHANGERS

- Used to read pressure when inflating tires after installation
- Works with many COATS® tire machines (this is the gauge located in the upper arm support that tells you pressure in the tire as you inflate them with the tire machine)
- Also used on older rectangle Cabinet Tire Machines
- This quality air gauge mounts to the machine with 3 small rivets around the outer steel flange of the gauge (*rivets included with the gauge*)

Ascot No.	Mfg. No.	Description
444-17985	AG107985	Flange Mount Air Gauge for Coats Tire Changers

www.ascotsupply.com

⚠️ WARNING: For more information go to www.P65Warnings.ca.gov.

444-22019
Long Sock for Bead Lifting Tool



444-99719
Low Profile Bead Lever Tool



DURABLE PLASTIC MATERIAL

437-00001
Tire Swab, 11" x 2"

437-00002
Tire Swab, 15" x 2"

437-00003
Tire Swab, 18" x 3"

437-13014
Hunter-Style Tire Lubricating Brush

444-17985
Flange Mount Air Gauge for Coats Tire Changers



LUBE BUCKETS FOR TIRE CHANGERS

STRAIGHT LUBE BUCKET:

- Designed for holding tire lubricants on Center-Post tire changers
- *Compatible with COATS 4040, 4040SA & 4050*
- Made from a durable plastic material
- **Equivalent to COATS 106572**

ANGLED LUBE BUCKET:

- Designed for holding tire lubricants on Rim Clamp tire changers
- *Compatible with COATS RC15, RC20, 5060 & 5070 tire changers*
- Made from a durable plastic material
- **Equivalent to COATS 106259**

844-16259
Straight
Lube Bucket

844-16572
Angled Lube
Bucket

Ascot No.	Mfg. No.	Description
844-16259	LB106259	Straight Lube Bucket
844-16572	LB106572	Angled Neck Lube Bucket

COATS REPLACEMENT AIR HOSE

- For use with Coats Tire Changers
- 60" long x 1/4" diameter
- AC-1 Euro-style chuck
- All brass connectors
- Swivel fitting
- **Equivalent to Coats 806871**

Ascot No.	Mfg. No.	Description
127-86871	86871-1	60" x 1/4" Coats Replacement Air Hose (Packaged 1 per bag)

127-86871
Coats Replacement
Air Hose

HUNTER REPLACEMENT AIR HOSE

- 60" long x 1/4" diameter
- European -style air chuck
- All brass connectors
- Packaged 1 per bag

Ascot No.	Mfg. No.	Description
127-86872	86872-1	Hunter Replacement Air Hose

127-86872
Hunter Replacement
Air Hose

STORAGE CABINET FOR RIM CLAMP TIRE CHANGERS

- Universal- Easily attaches to most swing arm rim clamp tire changers
- Two gear clamps for attaching to tower included
- 14" W x 23" H x 8.5" D
- Black Powder coat finish
- Lube bottle bracket (not pictured) on side
- **MADE IN USA**

Ascot No.	Mfg. No.	Description
719-82222	TOOTCCAB	Storage Cabinet for Rim Clamp Tire Changers



719-82222
Storage Cabinet
for Rim Clamp
Tire Changers

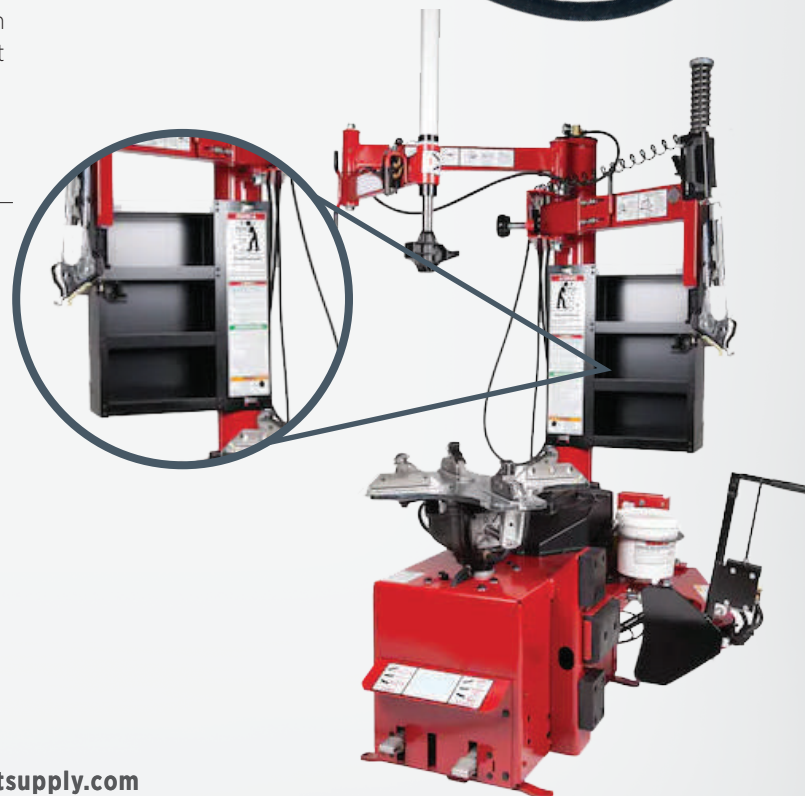
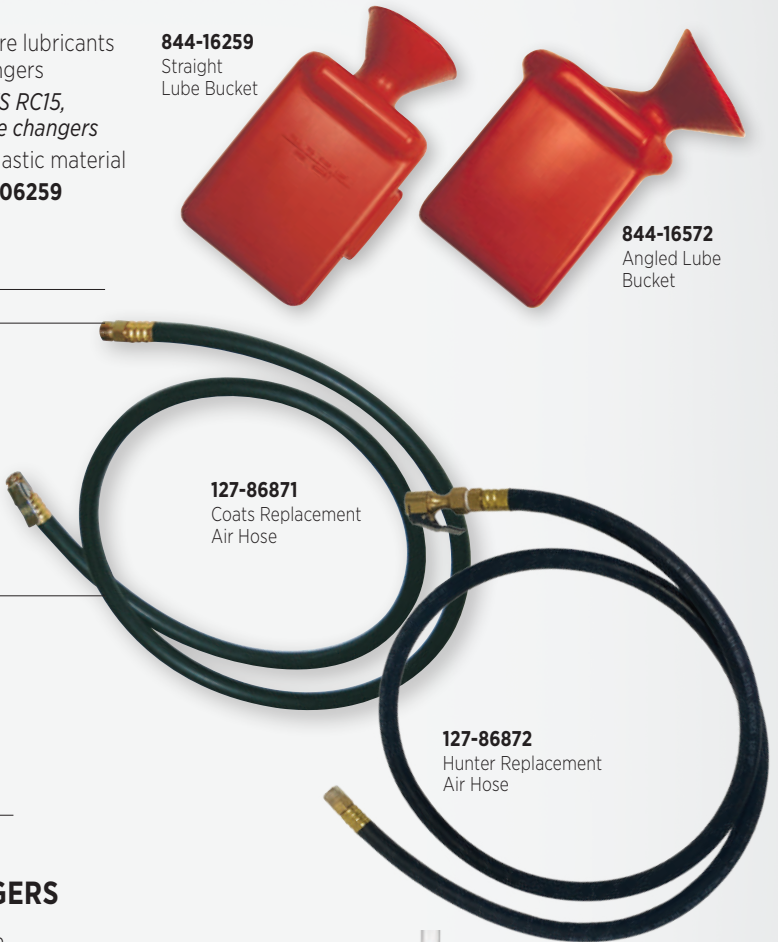

BRUSHES & LUBRICANTS



535-00150
Wooden Handled Wire
Brush with Metal Scraper

WOODEN HANDLED WIRE BRUSH WITH METAL SCRAPER

- 19 rows of steel bristles
- Slightly curved wooden handle
- *Metal scraper included*
- **BRISTLE LENGTH:** 1"
- **OVERALL LENGTH:** 14-1/4"



Ascot No.	Mfg. No.	Description
535-00150	VT-931	Wooden Handled Wire Brush with Metal Scraper



395-13124
Plastic Handled Brass
Sidewall Brush

PLASTIC HANDLED BRASS SIDEWALL BRUSH

- Densely packed brass bristles
- Great for cleaning white sidewall tires
- **BRISTLE LENGTH:** 3/4"
- **OVERALL LENGTH:** 8-1/4"
- Plastic handle fits comfortably in the hand
- **Colors may vary**

Ascot No.	Mfg. No.	Description
395-13124	VT-932	Plastic Handled Brass Sidewall Brush



535-14159
Scratch Brush

SCRATCH BRUSH

- 7 rows of steel bristles
- Ridged handle for better grip
- Common applications include cleaning dirt, rust, scale, chips and paint as well as plating and welding operations



535-14166
8" Tube Brush

Ascot No.	Mfg. No.	Size	Width/ Face	Rows	Fill Wire	Wire Dia.	Trim Length
535-14159	14159	7-1/2"	7-1/2"	3x7	Stainless Steel	0.006"	7-1/2"



535-14168
6.5" Tube Brush

TUBE BRUSHES

- For internal cleaning and deburring of copper tube fittings

Ascot No.	Mfg. No.	Length	Brush Length	Dia.	Fill Wire	Trim Length
535-14168	14168	6-1/2"	1"	5/8"	Steel	—
535-14169	14169	6-1/2"	1"	1/2"	Steel	—
535-14180	14180	6-1/2"	1"	3/4"	Steel	—



535-14169
6.5" Tube Brush



Quality | Innovation | Service

Mounting, Painting, or Troubleshooting Tires...
Murphy's Gives You an Edge

Murphy's Marvels



Off The Rim

An excellent water-based lubricant to help ease tires off the rim by penetrating between the bead and tire flanges.

Tire and Tube

Designed to assist in mounting rubber tires and tubes on all types of wheels. It is fortified with rust inhibitors to provide protection against wheel corrosion.

Black Tire Paint

Your new competitive advantage for a great retread finish. Water-Based, Matte Finish, and Quick Drying.



BRUSHES & LUBRICANTS



309-10925
Hydraulic Jack oil



408-00116
B'Laster Penetrant w/ ProStraw

ASCOT PREMIUM HYDRAULIC JACK OIL-QUARTS

- 12 bottles per case
- Designed for year-round use in a wide array of temperatures
- Outstanding anti-wear properties
- Rust and corrosion resistant
- Excellent foam suppression
- Promotes long equipment life
- Exceptional oxidation stability
- **MADE IN USA**

Ascot No.	Mfg. No.	Description
309-10925	N/A	Ascot Premium Hydraulic Jack Oil - Quarts

B'LASTER PENETRANT W/ PROSTRAW

- #1 selling penetrant
- Breaks free rusted or frozen parts
- Protects against further rust and corrosion
- Use on automotive, industrial, marine, plumbing and other equipment
- New ProStraw™ with Control Flow Technology™
- **QUANTITY:** 12 cans per case

Ascot No.	Mfg. No.	Description
408-00116	16-PB-DS	B'laster Penetrant w/ ProStraw™, 11 oz. Can (12 per case)



433-25431
Ascot EZ Check Leak Detector, Gallon

EZ CHECK LEAK DETECTOR

- Finds leaks in all tires
- Environmentally friendly
- Excellent foam formation
- Skin friendly
- *Commercial use only*
- **MADE IN USA**

Ascot No.	Mfg. No.	Description
433-25430	2543	Ascot EZ Check Leak Detector, Quart (12 per case)
433-25431	2543-1G	Ascot EZ Check Leak Detector, Gallon (4 per case)

433-25430
Ascot EZ Check Leak Detector, Quart



433-10232
Ascot Concentrated Leak Detector, Quart

433-10231
Ascot Concentrated Leak Detector, Gallon

ASCOT CONCENTRATED LEAK DETECTOR

- Detects leaks in all tires
- Environmentally friendly
- Excellent foam formation
- Non-offensive aroma
- Commercial use only
- **MADE IN USA**

Ascot No.	Mfg. No.	Description
433-10231	F4.0231	Ascot Concentrated Leak Detector, Gallon (4 per case)
433-10232	F4.0232	Ascot Concentrated Leak Detector, Quart (12 per case)

ASCOT BLACK RIM RUST RETARDANT

- Recommended for rims, tires, wheels and 5th wheel
- Prevents scale & rust formation
- Lubricates rim and tire for easy installation or removal
- Protects tires, wheels, tire flaps and rims for many changes
- *Ryder approved*
- **MADE IN USA**

Ascot No.	Mfg. No.	Description
435-06001	065-2539	Ascot Black Rim Rust Retardant, 5 lb. (6 per Case)
435-06002	025-2539	Ascot Black Rim Rust Retardant, 25 lb.
435-06008	048-2539	Ascot Black Rim Rust Retardant, 8 lb. (4 per Case)



435-06001

435-06002

435-06008

www.ascotsupply.com

⚠ WARNING: For more information go to www.P65Warnings.ca.gov.

BRUSHES & LUBRICANTS

ASCOT TIRE AND TUBE MOUNTING COMPOUND

- **VERSATILE FORMULA:** Dilutes to any strength your job requires
- Approved by major tire companies world-wide
- Made from natural, renewable resources
- Totally safe for all tires
- Economical when diluted
- Ultra-thick concentrate for excellent performance when packing beads
- **MADE IN USA**

Ascot No.	Mfg. No.	Description
432-02028	2028	Ascot Tire and Tube Mounting Compound, 8 lb. Pail (4 per Case)
432-02029	2029	Ascot Tire and Tube Mounting Compound, 25 lb. Pail
432-02035	2035	Ascot Tire and Tube Mounting Compound, 40 lb. Pail

MURPHY'S CONCENTRATED TIRE & TUBE MOUNTING COMPOUND

- **VERSATILE FORMULA:** Dilutes to any strength your job requires
- Approved by major tire companies world-wide
- Made from natural, renewable resources
- Totally safe for all tires
- Economical when diluted
- Ultra-thick concentrate for excellent performance when packing beads
- **MADE IN USA**

Ascot No.	Mfg. No.	Description
432-02000	2000	Murphy's Concentrated Tire & Tube Mounting Compound, 8 lb. Pail (4 per Case)
432-02005	2005	Murphy's Concentrated Tire & Tube Mounting Compound, 25 lb. Pail
432-02008	2008	Murphy's Concentrated Tire & Tube Mounting Compound, 40 lb. Pail
432-02014	2014	Murphy's Concentrated Tire & Tube Mounting Compound, 445 lb. Drum

ASCOT WHITE TIRE MOUNTING PASTE

- Designed for alloy wheels, low profile and run flat tires
- No water, no mixing. Use right from the container
- Extra slippery to help mount tires with stiff beads
- Apply with brush
- Makes tire mounting faster and easier
- Approved by major rubber companies
- Ideal for lubricating bead seaters
- For mounting and demounting tires
- **MADE IN USA**



Ascot No.	Mfg. No.	Description
432-02046	2046	Ascot White Tire Mounting Paste, 8 lb. Pail (4 per Case)
432-02067	2067	Ascot White Tire Mounting Paste, 8 lb. Low Profile Pail (4 per Case)
432-02088	2088	Ascot White Tire Mounting Paste, 22 lb. Pail

TIRE CHANGER BRACKETS FOR TIRE MOUNTING PASTE

- Manufactured from heavy duty steel
- Mounts directly to a variety of different tire changers
- Designed to hold tire paste buckets
- Mounting hardware included
- (2) self-tapping screws, (2) bolts, (4) washers
- **Made in Taiwan**



Ascot No.	Mfg. No.	Description
432-12046	2046B	Bracket for Ascot White Tire Mounting Paste
432-12067	2067B	Bracket for Ascot Low Profile White Tire Mounting Paste



432-02029
Ascot Tire and Tube Mounting Compound, 25 lb. Pail



432-02005
Murphy's Concentrated Tire & Tube Mounting Compound, 25 lb. Pail



Pink Mounting Paste Coming Soon Fall 2024!



432-02067

432-02046



432-02088

432-12046
Brackets for Tire Mounting Paste

432-12047
Brackets for Tire Mounting Paste

BRUSHES & LUBRICANTS

432-02167
Murphy's White
Tire Mounting
Paste, 8 lb. Low
Profile Pail



MURPHY'S WHITE TIRE MOUNTING PASTE

- Designed for alloy wheels, low profile and run flat tires
- Extra Slippery to help mount tires with stiff beads
- No water, no mixing. Use right from the container
- Contains rust inhibitor to help fight rim rust
- **MADE IN USA**

Ascot No.	Mfg. No.	Description
432-02146	2146	Murphy's White Tire Mounting Paste, 8 lb. Pail (4 per Case)
432-02167	2167	Murphy's White Tire Mounting Paste, 8 lb. Low Profile Pail (4 per Case)



434-02110
Murphy's
Non-Rust
Rim-Kote,
30 lb. Pail

MURPHY'S NON-RUST RIM-KOTE

- Contains no petroleum and prevents rim rust and scale
- Prevents tire bead freezing and helps seat tubeless tires in sub-freezing temperatures
- Recommended for mounting tires on heavy duty trucks, buses, and off-the-road vehicles
- **MADE IN USA**

Ascot No.	Mfg. No.	Description
434-02110	2110	Murphy's Non-Rust Rim-Kote, 30 lb. Pail
434-02120	2120	Murphy's Non-Rust Rim-Kote, 40 lb. Pail



497-11800
Murphy's Black
Tire Paint

MURPHY'S BLACK TIRE PAINT

- Ready to Use - No dilution needed
- Easy to apply in tire paint machines or by brush
- Quick drying
- Matte black finish
- Superior hiding ability over wax or chalk markings
- Water-base for easy cleanup
- **MADE IN USA**

Ascot No.	Mfg. No.	Description
497-11800	F1.7800	Murphy's Black Tire Paint 5-Gallon Pail
497-11801	F1.1801	Murphy's Black Tire Paint 55-Gallon Drum



433-01950
Murphy's Concentrated
Extra Slippery Liquid
Lubricant, 1 Gallon

MURPHY'S LIQUID LUBRICANT

- Ready to use liquid for easy application
- Designed to assist in mounting rubber tires and tubes on all types of wheels
- Easy clean up and non-toxic
- Contains rust inhibitor to help fight rust
- **MADE IN USA**

Ascot No.	Mfg. No.	Description
433-02020	2020	Murphy's Liquid Lubricant, 1 Gallon (4 per Case)
433-02023	2023	Murphy's Liquid Lubricant, 5 Gallons
433-02022	2022	Murphy's Liquid Lubricant, 55 Gallons



433-02020
Murphy's Liquid
Lubricant 1 Gallon

MURPHY'S CONCENTRATED EXTRA SLIPPERY LIQUID LUBRICANT

- Contains improved super lubricity polymers
- Rust inhibitor added to help fight rim rust
- **ECONOMICAL:** Dilutes 2 to 1
- Formulated for super-fast mount of passenger tires
- **MADE IN USA**

Ascot No.	Mfg. No.	Description
433-01950	1950	Murphy's Concentrated Extra Slippery Liquid Lubricant, 1 Gallon (4 per Case)
433-01957	1957	Murphy's Concentrated Extra Slippery Liquid Lubricant, 5 Gallons
433-01958	1958	Murphy's Concentrated Extra Slippery Liquid Lubricant, 55 Gallons

www.ascotsupply.com

⚠️ WARNING: For more information go to www.P65Warnings.ca.gov.

BRUSHES & LUBRICANTS

ASCOT LIQUID BEAD BUSTER

- Multi-purpose shop tool which penetrates, lubricates, cleans, and protects most metal surfaces
- Quickly dissolves and loosens rust, corrosion, and scale
- Prevents broken parts
- **Non-flammable, non-combustible**
- Time saving tire bead breaker
- Penetrates deep into tight spaces
- **Similar to SKID penetrating lubricant**
- **MADE IN USA**

Ascot No.	Mfg. No.	Description
431-00001	ASL-1	Liquid Bead Buster (4) 1-Gallon Bottles
431-00005	ASL-5	Liquid Bead Buster 5-Gallon Pail
431-00055	ASL-55	Liquid Bead Buster 55-Gallon Drum



431-00001

431-00055

431-00005

IMI STS TIRE SEAL

- Seals 2x more punctures than the competition
- Permanently seals punctures up to 1/4"
- Prevents wheel corrosion, glycol free
- Non-toxic, non-flammable, non-combustible
- 100% bio-degradable and water soluble
- Lasts for the lifetime of the tire
- Wide range of applications
- Low freeze point, freeze/thaw stable

Ascot No.	Mfg. No.	Description
451-00036	STSOTR6G	STS OTR TIRE SEAL - 6-Gallon Pail
451-00640	STS640	STS TIRE SEAL - 5-Gallon Pail
451-02640	STSOTR640	STS OTR TIRE SEAL - 5-Gallon Pail



451-00640

Tire Seal 5-Gallon Bail

451-02640

Tire Seal OTR 5-Gallon Bail

GAITHER SUPER SLICK'EM

- Gaither's Super Slick'em™ should be applied to all tires before deflation if being dismantled
- Super Slick'em™ is a special non-water based lubricant that penetrates and aids in breaking the tire bead from the wheel by eating away rust and grease. Because it does not contain water, Super Slick'em™ will not freeze or cause rust to form
- Includes : 4-1 gallon (3.8 liter) containers and 1 applicator bottle



421-12904

Gaither Super Slick'em

Ascot No.	Mfg. No.	Description
421-12904	G12904	Gaither Super Slick'em

BRUSHES & LUBRICANTS



SLICK



- Contains rust inhibitor to prevent rusting of rims
- Tire adheres to rim. Will not slip
- Helps to seal tire bead. Reduces bead damage
- Will not gum up the bead or rim to hinder its future use
- Reduces friction. Saves wear and repair on tire changers
- **Contains no soap or petroleum products**

Ascot No.	Mfg. No.	Description
432-57304	55073-4	(4) 1-Gallon Bottles
432-57305	55073-5	5-Gallon Pail
432-57355	55073-55	55-Gallon Drum
432-57270	55073-270	275-Gallon Tote



INDUSTRIAL SPRAY BOTTLES

- Industrial sprayer for use with light oils, solvents, and detergents
- The durable polyethylene bottle is impervious to high and low temperatures
- The trigger mechanism is resistant to damage caused by caustic materials

Ascot No.	Mfg. No.	Description
632-00922	TH97016	Industrial Spray Bottle - 16 oz. Capacity
632-00923	TH97032	Industrial Spray Bottle - 32 oz. Capacity

632-00923
32 oz. Capacity

632-00922
16 oz. Capacity

ANODIZED ALUMINUM SPRAYER

- Adjustable pistol-grip nozzle
- Features a chemical resistant anodized finish
- Will work with water, solvent & oil-based materials
- **Replaces Model "A" plated brass sprayers**
- 24 oz. capacity
- **MAX PRESSURE: 200 PSI**

Ascot No.	Mfg. No.	Description
632-02400	2400S	Anodized Aluminum Sprayer



632-00032
1.5 Liter Sprayer



1.5 LITER SPRAYER W/ VITON SEAL

- 1.5 liter capacity
- Easy to use compression action sprayer
- Ergonomic design with strong translucent tank with level indicator
- Adjustable spray nozzle is great for applying a variety of liquids
- Durable with exceptional chemical resistance
- Easy to clean and maintain
- Can Be used with liquid bead sealer
- **MADE IN CHINA**

Ascot No.	Mfg. No.	Description
632-00032	AS-32	1.5 Liter Sprayer w/ Viton Seal

TIRE BRANDERS & REGROOVING TOOLS

SURE SHOT PRESSURE SPRAYERS

- Air pressurized and refillable
- For brake and parts cleaner, penetrating oils, lubricants, degreasers, solvents
- Environmentally safe, eliminates aerosol usage
- **MADE IN THE USA**

Ascot No.	Mfg. No.	Description
632-01002	A1002	Sure Shot Black Enameled Steel Sprayer w/ Adjustable Nozzle
632-10001	A1000R	Sure Shot Enameled Steel Sprayer (Red)
632-00005	K-5	Partial Repair Kit for Model A Sure Shot Sprayers
632-00010	K-10	Complete Repair Kit for Model A Sure Shot Sprayers



632-02400
Anodized Aluminum Sprayer

632-01002
Sure Shot Pressure Sprayer

1/4", 1/2" & 1" TIRE BRANDER CHARACTER SETS

Ascot No.	Mfg. No.	Description
TIRE BRANDER CHARACTER SETS		
452-00001	TBINOSET	1" Tire Brander Number Set
452-00012	TBI/2NOSET	1/2" Tire Brander Number Set
452-00014	TBI/4NOSET	1/4" Tire Brander Number Set
452-00112	TBI/2LETSET	1/2" Tire Brander Letter Set
452-00114	TBI/4LETSET	1/4" Tire Brander Letter Set
452-00011	TBILETSET	1" Tire Brander Letter Set



1" Letters and Numbers for Tire Branders

1" LETTERS AND NUMBERS

Ascot No.	Mfg. No.	Description
1" LETTERS & NUMBERS		
452-00001	TBINOSET	Tire Brander 1" Number Set
452-00011	TBILETSET	Tire Brander 1" Letter Set
452-00100	BI-CC-1BZ-0	Tire Brander 1" Insert: 0
452-00101	BI-CC-1BZ-1	Tire Brander 1" Insert: 1
452-00102	BI-CC-1BZ-2	Tire Brander 1" Insert: 2
452-00103	BI-CC-1BZ-3	Tire Brander 1" Insert: 3
452-00104	BI-CC-1BZ-4	Tire Brander 1" Insert: 4
452-00105	BI-CC-1BZ-5	Tire Brander 1" Insert: 5
452-00106	BI-CC-1BZ-6	Tire Brander 1" Insert: 6
452-00107	BI-CC-1BZ-7	Tire Brander 1" Insert: 7
452-00108	BI-CC-1BZ-8	Tire Brander 1" Insert: 8
452-00109	BI-CC-1BZ-9	Tire Brander 1" Insert: 9
452-00201	BI-CC-1BZ-A	Tire Brander 1" Insert: A
452-00202	BI-CC-1BZ-B	Tire Brander 1" Insert: B
452-00203	BI-CC-1BZ-C	Tire Brander 1" Insert: C
452-00204	BI-CC-1BZ-D	Tire Brander 1" Insert: D
452-00205	BI-CC-1BZ-E	Tire Brander 1" Insert: E
452-00206	BI-CC-1BZ-F	Tire Brander 1" Insert: F
452-00207	BI-CC-1BZ-G	Tire Brander 1" Insert: G
452-00209	BI-CC-1BZ-I	Tire Brander 1" Insert: I
452-00211	BI-CC-1BZ-K	Tire Brander 1" Insert: K
452-00212	BI-CC-1BZ-L	Tire Brander 1" Insert: L
452-00213	BI-CC-1BZ-M	Tire Brander 1" Insert: M

Ascot No.	Mfg. No.	Description
1" LETTERS & NUMBERS (CONT.)		
452-00214	BI-CC-1BZ-N	Tire Brander 1" Insert: N
452-00215	BI-CC-1BZ-O	Tire Brander 1" Insert: O
452-00216	BI-CC-1BZ-P	Tire Brander 1" Insert: P
452-00217	BI-CC-1BZ-Q	Tire Brander 1" Insert: Q
452-00218	BI-CC-1BZ-R	Tire Brander 1" Insert: R
452-00219	BI-CC-1BZ-S	Tire Brander 1" Insert: S
452-00220	BI-CC-1BZ-T	Tire Brander 1" Insert: T
452-00221	BI-CC-1BZ-U	Tire Brander 1" Insert: U
452-00222	BI-CC-1BZ-V	Tire Brander 1" Insert: V
452-00223	BI-CC-1BZ-W	Tire Brander 1" Insert: W
452-00224	BI-CC-1BZ-X	Tire Brander 1" Insert: X
452-00226	BI-CC-1BZ-Z	Tire Brander 1" Insert: Z



1" Letters for Tire Branders

TIRE BRANDERS & REGROOVING TOOLS

LETTERS AND NUMBERS FOR TIRE BRANDERS (CONT.)

1/2" LETTERS AND NUMBERS

Ascot No.	Mfg. No.	Description
1/2" LETTERS & NUMBERS		
452-00012	TBI/2NOSET	Tire Brander 1/2" Number Set
452-00112	TBI/2LETSET	Tire Brander 1/2" Letter Set
452-02100	BI-CC-1/2BR-0	Tire Brander 1/2" Insert: 0
452-02101	BI-CC-1/2BR-1	Tire Brander 1/2" Insert: 1
452-02102	BI-CC-1/2BR-2	Tire Brander 1/2" Insert: 2
452-02103	BI-CC-1/2BR-3	Tire Brander 1/2" Insert: 3
452-02104	BI-CC-1/2BR-4	Tire Brander 1/2" Insert: 4
452-02105	BI-CC-1/2BR-5	Tire Brander 1/2" Insert: 5
452-02106	BI-CC-1/2BR-6	Tire Brander 1/2" Insert: 6
452-02107	BI-CC-1/2BR-7	Tire Brander 1/2" Insert: 7
452-02108	BI-CC-1/2BR-8	Tire Brander 1/2" Insert: 8
452-02109	BI-CC-1/2BR-9	Tire Brander 1/2" Insert: 9
452-00501	BI-CC-1/2BR-A	Tire Brander 1/2" Insert: A
452-00502	BI-CC-1/2BR-B	Tire Brander 1/2" Insert: B
452-00503	BI-CC-1/2BR-C	Tire Brander 1/2" Insert: C
452-00504	BI-CC-1/2BR-D	Tire Brander 1/2" Insert: D
452-00505	BI-CC-1/2BR-E	Tire Brander 1/2" Insert: E
452-00506	BI-CC-1/2BR-F	Tire Brander 1/2" Insert: F
452-00507	BI-CC-1/2BR-G	Tire Brander 1/2" Insert: G
452-00508	BI-CC-1/2BR-H	Tire Brander 1/2" Insert: H
452-00509	BI-CC-1/2BR-I	Tire Brander 1/2" Insert: I
452-00510	BI-CC-1/2BR-J	Tire Brander 1/2" Insert: J
452-00511	BI-CC-1/2BR-K	Tire Brander 1/2" Insert: K
452-00512	BI-CC-1/2BR-L	Tire Brander 1/2" Insert: L
452-00513	BI-CC-1/2BR-M	Tire Brander 1/2" Insert: M
452-00514	BI-CC-1/2BR-N	Tire Brander 1/2" Insert: N
452-00515	BI-CC-1/2BR-O	Tire Brander 1/2" Insert: O
452-00516	BI-CC-1/2BR-P	Tire Brander 1/2" Insert: P
452-00517	BI-CC-1/2BR-Q	Tire Brander 1/2" Insert: Q
452-00518	BI-CC-1/2BR-R	Tire Brander 1/2" Insert: R
452-00519	BI-CC-1/2BR-S	Tire Brander 1/2" Insert: S
452-00520	BI-CC-1/2BR-T	Tire Brander 1/2" Insert: T
452-00521	BI-CC-1/2BR-U	Tire Brander 1/2" Insert: U
452-00522	BI-CC-1/2BR-V	Tire Brander 1/2" Insert: V
452-00523	BI-CC-1/2BR-W	Tire Brander 1/2" Insert: W
452-00524	BI-CC-1/2BR-X	Tire Brander 1/2" Insert: X
452-00525	BI-CC-1/2BR-Y	Tire Brander 1/2" Insert: Y
452-00526	BI-CC-1/2BR-Z	Tire Brander 1/2" Insert: Z

1/4" LETTERS AND NUMBERS

Ascot No.	Mfg. No.	Description
1/4" LETTERS & NUMBERS		
452-00014	TBI/4NOSET	Tire Brander 1/4" Number Set
452-00114	TBI/4LETSET	Tire Brander 1/4" Letter Set
452-01100	BI-CC-1/4BR-0	Tire Brander 1/4" Insert: 0
452-01101	BI-CC-1/4BR-1	Tire Brander 1/4" Insert: 1
452-01102	BI-CC-1/4BR-2	Tire Brander 1/4" Insert: 2
452-01103	BI-CC-1/4BR-3	Tire Brander 1/4" Insert: 3
452-01104	BI-CC-1/4BR-4	Tire Brander 1/4" Insert: 4
452-01105	BI-CC-1/4BR-5	Tire Brander 1/4" Insert: 5
452-01106	BI-CC-1/4BR-6	Tire Brander 1/4" Insert: 6
452-01107	BI-CC-1/4BR-7	Tire Brander 1/4" Insert: 7
452-01108	BI-CC-1/4BR-8	Tire Brander 1/4" Insert: 8
452-01109	BI-CC-1/4BR-9	Tire Brander 1/4" Insert: 9
452-00401	BI-CC-1/4BR-A	Tire Brander 1/4" Insert: A
452-00402	BI-CC-1/4BR-B	Tire Brander 1/4" Insert: B
452-00403	BI-CC-1/4BR-C	Tire Brander 1/4" Insert: C
452-00404	BI-CC-1/4BR-D	Tire Brander 1/4" Insert: D
452-00405	BI-CC-1/4BR-E	Tire Brander 1/4" Insert: E
452-00406	BI-CC-1/4BR-F	Tire Brander 1/4" Insert: F
452-00407	BI-CC-1/4BR-G	Tire Brander 1/4" Insert: G
452-00408	BI-CC-1/4BR-H	Tire Brander 1/4" Insert: H
452-00409	BI-CC-1/4BR-I	Tire Brander 1/4" Insert: I
452-00410	BI-CC-1/4BR-J	Tire Brander 1/4" Insert: J
452-00411	BI-CC-1/4BR-K	Tire Brander 1/4" Insert: K
452-00412	BI-CC-1/4BR-L	Tire Brander 1/4" Insert: L
452-00413	BI-CC-1/4BR-M	Tire Brander 1/4" Insert: M
452-00414	BI-CC-1/4BR-N	Tire Brander 1/4" Insert: N
452-00415	BI-CC-1/4BR-O	Tire Brander 1/4" Insert: O
452-00416	BI-CC-1/4BR-P	Tire Brander 1/4" Insert: P
452-00418	BI-CC-1/4BR-R	Tire Brander 1/4" Insert: R
452-00419	BI-CC-1/4BR-S	Tire Brander 1/4" Insert: S
452-00420	BI-CC-1/4BR-T	Tire Brander 1/4" Insert: T
452-00421	BI-CC-1/4BR-U	Tire Brander 1/4" Insert: U
452-00422	BI-CC-1/4BR-V	Tire Brander 1/4" Insert: V
452-00423	BI-CC-1/4BR-W	Tire Brander 1/4" Insert: W
452-00424	BI-CC-1/4BR-X	Tire Brander 1/4" Insert: X
452-00425	BI-CC-1/4BR-Y	Tire Brander 1/4" Insert: Y
452-00426	BI-CC-1/4BR-Z	Tire Brander 1/4" Insert: Z

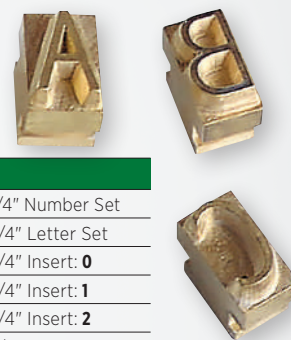

1/2" Letters for Tire Branders



1/4" Letters for Tire Branders

TIRE REGROOVING TOOLS & ACCESSORIES

Ascot No.	Mfg. No.	Description
455-00003	RC414	Rubber Cut 414 Regroover
455-00401	W-1	Regroover Blades 20-Pack
455-00402	W-2	Regroover Blades 20-Pack
455-00403	W-3	Regroover Blades 20-Pack
455-00404	W-4	Regroover Blades 20-Pack
455-00405	W-5	Regroover Blades 20-Pack
455-00406	W-6	Regroover Blades 10-Pack



455-00003 Rubber Cut 414 Regroover

MISCELLANEOUS TIRE SERVICING TOOLS



2" QUICK CHANGE SURFACE CONDITIONING DISCS

- Available in fine, medium or coarse provide a consistent finish
- Embedded with abrasive grain to eliminate fraying of edges, resist loading and
- Ideal for flat or contoured surfaces
- **Made in USA**

Ascot No.	Mfg. No.	Description
417-39120	3912BLUEF	2" Quick Change Surface Conditioning Discs: Blue (Fine)
417-39121	3912MARNM	2" Quick Change Surface Conditioning Discs: Maroon (Medium)
417-39122	3912BRWNC	2" Quick Change Surface Conditioning Discs: Brown (Coarse)
417-13003	620TE-1	2" Surface Conditioning Discs: Brown (Coarse) 25/box
417-13004	622TE-1	2" Surface Conditioning Discs: Maroon (Medium)
417-13005	620TE-1-50	2" Surface Conditioning Discs: Brown (Coarse) 50/box



3" QUICK CHANGE SURFACE CONDITIONING DISCS

- Features the quick and easy "R" type backing
- Ideal for general grinding, rust removal, clean-up and paint removal
- Use with right angle or die grinders
- Ideal for flat contoured surfaces
- **Made in USA**

Ascot No.	Mfg. No.	Description
417-13006	630TE	3" Quick Change Surface Conditioning Discs 25/box
417-13007	632TE	3" Quick Change Surface Conditioning Discs 25/box



3" STRIP-BRITE PADS

- Feature the quick and easy twist-to-lock attachment system
- Provide aggressive and long lasting performance
- Durable, three-dimensional web with a soft edge in unreachable creases and dents without damaging metal
- **Made in USA**

Ascot No.	Mfg. No.	Description	Qty
417-16210	16210	2" Strip-Brite Pad - Purple (Coarse)	10/box
417-16211	16211	3" Strip-Brite Pad - Purple (Coarse)	10/box



GREEN ZIRCONIA DISCS

- Twist-to-lock backing
- Offers longer life and more aggressive results than zirconia or aluminum oxide
- Flexible discs resist chipping, snagging and cracking
- 20,000 RPM
- For use on air grinders and are compatible with all 3M style, Type "R" backing pads
- Especially good on extra hard metals
- 25 per box
- **Made in USA**

Ascot No.	Mfg. No.	Description	Qty
417-12612	12612	2" Green Zirconia Grinding Disc - 24 Grit	25/box
417-12613	12613	2" Green Zirconia Grinding Disc - 36 Grit	25/box
417-12614	12614	2" Green Zirconia Grinding Disc - 50 Grit	25/box
417-12615	12615	2" Green Zirconia Grinding Disc - 80 Grit	25/box
417-12617	12617	3" Green Zirconia Grinding Disc - 36 Grit	25/box
417-12618	12618	3" Green Zirconia Grinding Disc - 50 Grit	25/box
417-12619	12619	3" Green Zirconia Grinding Disc - 80 Grit	25/box



MISCELLANEOUS TIRE SERVICING TOOLS

535-14160
2" Power Crimped Wheel



535-14161
3" Power Crimped Wheel

535-14162
3" Power Crimped Wheel



535-14163
3" Power Crimped Wheel

POWER CRIMPED WHEELS

- Small diameter crimped wire wheels
- Solid ring construction for high-speed use
- Copper center
- Plain arbor hole for use on a variety of portable tools and stationary machines

Ascot No.	Mfg. No.	Size	Width/Face	Arbor	Fill Wire	Wire Dia.	Trim Length	RPM
535-14160	14160	2"	3/8"	1/2"-3/8"	Steel	0.0118"	1/2"	20,000
535-14161	14161	3"	5/8"	1/2"-3/8"	Steel	0.0118"	1"	20,000
535-14162	14162	3"	5/8"	1/2"	Steel	0.006"	1"	20,000
535-14163	14163	3"	5/8"	1/2"-3/8"	Steel	0.008"	1"	20,000



417-39203
Backing Pad for 3" Surface Conditioning Discs



417-39202
Backing Pad for 2" Surface Conditioning Discs

BACKING PADS FOR SURFACE CONDITIONING DISCS

- Compatible with all twist-to-lock brands of discs
- Rigid rubber pad
- Twist-to-lock attachment
- Use with surface prep, mini grinding, strip-it and mini flap discs

Ascot No.	Mfg. No.	Description
417-39203	13013	Backing Pad for 3" Surface Conditioning Discs
417-39202	13012	Backing Pad for 2" Surface Conditioning Discs



535-14164
3" Crimped Encapsulated Wire Wheel



535-14181
3" Crimped Encapsulated Wire Wheel

CRIMPED ENCAPSULATED WIRE WHEELS

- Elastomer gradually wears exposing consistent short trim for maximum aggression and long life

Ascot No.	Mfg. No.	Size	Width/Face	Arbor	Fill Wire	Wire Dia.	Trim Length	RPM
535-14164	14164	3"	1/4"	1/2"	Steel	0.0118"	1"	20,000
535-14181	14181	3"	1/4"	1/2"	Steel	0.014"	1"	20,000

417-12704
Cut-Off Wheels
10 Pack

417-12704
Cut-Off Wheels



CUT-OFF WHEELS

- Reinforced with fiberglass
- Fast cutting abrasive can be used in a variety of applications, including steel cutting
- The fiberglass reinforcement provides greater tensile strength, as well as safety
- **Made in USA**

Ascot No.	Mfg. No.	Description
417-12704	12704	3" Cut Off Wheels (10 Pack)
417-12705	12705	3" Cut Off Wheels (50 Pack)



417-12705
Cut-Off Wheels
50 Pack

www.ascotsupply.com

⚠️ **WARNING:** For more information go to www.P65Warnings.ca.gov.

MISCELLANEOUS TIRE SERVICING TOOLS

KNOTTED END AND POWER BRUSHES

- Features a hollow end and heavy duty brushing action with some flexibility
- Ideal for more demanding cleaning applications in recessed areas

Ascot No.	Mfg. No.	Style	Size	Width/Face	Arbor	Fill Wire	Wire Dia.	Trim Length	RPM
535-14174	14174	Single Row Knotted Wire Cup Brush	3-1/4"	3/8"	1/4" Shank	Steel	0.014"	5/8"	25,000
535-14177	14177	Twist Knot Brush	4"	1/2"	1/2"-3/8"	Steel	0.020"	7/8"	25,000



535-14177
4" Twist Knot Power Brush



535-14174
3.25" Single Row Knotted Wire Cup Power Brush

POWER BRUSHES

- Provide heavy duty brushing action with some flexibility
- Ideal for demanding cleaning applications on somewhat irregular surfaces

Ascot No.	Mfg. No.	Style	Size	Width/Face	Arbor	Fill Wire	Wire Dia.	Trim Length	RPM
535-14165	14165	Twist Knot	3"	3/8"	1/2"-3/8"	Steel	0.014"	5/8"	25,000
535-14170	14170	Mounted Knot	3-1/4"	3/8"	1/4" Shank	Steel	0.014"	5/8"	25,000
535-14171	14171	Twist Knot	4"	1/2"	1/2"-3/8"	Steel	0.0118"	7/8"	25,000
535-14172	14172	Twist Knot	4"	1/2"	1/2"-3/8"	Steel	0.014"	7/8"	25,000
535-14173	14173	Twist Knot	4"	1/2"	5/8"-11	Steel	0.020"	7/8"	25,000
535-14175	14175	Twist Knot	4"	1/2"	1/2"-3/8"	Steel	0.020"	7/8"	25,000
535-14182	17682	Mounted Knot	3-1/4"	3/8"	1/4" Shank	Steel	0.020"	5/8"	25,000



535-14165
3" Twist Knot Power Brush



535-14170
3.25" Mounted Knot Power Brush



535-14171
4" Twist Knot Power Brush



535-14172
4" Twist Knot Power Brush



535-14173
4" Twist Knot Power Brush



535-14175
4" Twist Knot Power Brush



535-14176
4" Cable Twist Knot Power Brush



535-14182
3.25" Mounted Knot Power Brush

SAFETY INFLATION CAGES

479-36011
2-Bar Wide Base Foldable Inflation Cage



2-BAR FOLDABLE INFLATION CAGE

REGULAR

- **PORTABLE UNIT:** ideal for service trucks
- Compact and lightweight
- Meets or exceeds OSHA Standard 29 CFR 1910.177
- **DIMENSIONS:** 17" x 26" x 57"

WIDE BASE

- Especially designed for wide based tires
- Will accommodate super single and super wide radial tires
- **BASE (EFFECTIVE) WIDTH:** 22"
- **INSIDE (EFFECTIVE) HEIGHT:** 49-1/16"
- **WEIGHT:** 80 lb.
- Shipped in a cardboard box

Ascot No.	Mfg. No.	Description
479-36001	MIC-2	2- Bar Foldable Inflation Cage
479-36011	MIC-2WB	2-Bar Wide Base Foldable Inflation Cage



479-36006
3-Bar Inflation Cage



479-36013
3-Bar Passenger-SUV Inflation Cage

3-BAR, 4-BAR AND 5-BAR INFLATION CAGES

- Heavy duty steel construction
- Holds up to 54" diameter and 20" wide
- Meets or exceeds OSHA Standard 29 CFR 1910.177

Ascot No.	Mfg. No.	Description	Dimensions (L x W x H)
479-36006	MIC-3	3-Bar Inflation Cage	22" x 26" x 57"
479-36013	MIC-3SUV	3-Bar Passenger-SUV Inflation Cage	22" x 26" x 57"
479-36002	MIC-4	4-Bar Inflation Cage	32" x 26" x 57"
479-36005	MIC-5	5-Bar Inflation Cage	41" x 26" x 57"



479-36002
4-Bar Inflation Cage



479-36005
5-Bar Inflation Cage

60" 5-BAR TIRE INFLATION CAGE

- Specifically designed for use with trucks, military vehicles, tractors, aircraft & OTR applications
- **DIMENSIONS:** 41" x 39-1/2" x 68"
- Meets or exceeds OSHA Standard 29 CFR 1910.177

Ascot No.	Mfg. No.	Description
479-36015	MIC-OTR	60" 5-Bar Tire Inflation Cage

ROLLER FOR TIRE INFLATION CAGES

- Used to roll the tires easily directly into the inflation cage
- Allows for easy access to the tire valve because it is easy to turn the tire to have the valve to any position
- For use with all 3-bar, 4-bar & 5-bar inflation cages
- Prevent back injuries when handling heavy tires
- **WEIGHT:** 12 lb.

Ascot No.	Mfg. No.	Description
479-36111	MIC-ROLLER	Roller for Tire Inflation Cages



479-36015
60" 5-Bar Inflation Cage



479-36111
Roller for Tire Inflation Cages



WARNING: Never inflate a tire on a multi-piece rim (a rim made up of 2 or more separate pieces) unless the tire and rim are mounted in OSHA regulation 29-CFR Part 1910.177 or D.O.T. approved tire inflation cage.

SAFETY INFLATION CAGES

TIRE CAGE STAND FOR AUTOMATIC INFLATORS

- Used to support automatic inflators to tire inflation cages
- Reduces movement of automatic and allows for faster inflation of tires
- Install directly on the top of one of the inflation cage bars with the mounting bracket
- **WEIGHT:** 8 lb.

Ascot No.	Mfg. No.	Description
479-36112	MW-STAND	Tire Cage Stand for Automatic Inflators



479-36112
Tire Cage Stand for Automatic Inflators

KEN TOOL 2-BAR TIRE INFLATION CAGE

- Mandatory for any shop working with tubeless and multi-piece rims
- Made from heavy gauge steel tubing welded to a steel base
- Follow OSHA regulation 29-CFR Part 1910.177
- Designed to meet OSHA regulation requirements for medium, heavy duty truck, OTR, tractor & Super Singles

Ascot No.	Mfg. No.	Description
479-46001	36001	2-Bar Tire Inflation Cage Foldable

479-46001
2-Bar Tire Inflation Cage



479-46011
2-Bar Wide Base Tire Inflation Cage

KEN TOOL 2-BAR WIDE BASE TIRE INFLATION CAGE

- Mandatory for any shop working with tubeless and multi-piece rims
- Made from heavy gauge steel tubing welded to a steel base
- Follow OSHA regulation 29-CFR Part 1910.177
- Designed to meet OSHA regulation requirements for medium, heavy duty truck, OTR, tractor & Super Singles

Ascot No.	Mfg. No.	Description
479-46011	36007	2-Bar Wide Base Tire Inflation Cage Foldable



479-46002
4-Bar Tire Inflation Cage



479-46006
3-Bar Tire Inflation Cage

KEN TOOL 3-BAR, 4-BAR AND 5-BAR TIRE INFLATION CAGES

- Mandatory for any shop working with tubeless and multi-piece rims
- Made from heavy gauge steel tubing welded to a steel base
- Follow OSHA regulation 29-CFR Part 1910.177
- Designed to meet OSHA regulation requirements for medium, heavy duty truck, OTR, tractor & Super Singles

Ascot No.	Mfg. No.	Description
479-46002	36002	4-Bar Tire Inflation Cage
479-46005	36005	5-Bar Tire Inflation Cage
479-46006	36006	3-Bar Tire Inflation Cage



479-46005
5-Bar Tire Inflation Cage

WARNING: Never inflate a tire on a multi-piece rim (a rim made up of 2 or more separate pieces) unless the tire and rim are mounted in OSHA regulation 29-CFR Part 1910.177 or D.O.T. approved tire inflation cage.

AUTEL MAXI TPMS



**ONE TOOL.
EVERYTHING
TPMS. TS900**

ACTIVATE & RELEARN
ALL KNOWN TPMS SENSORS, INCLUDING
TESLA BLE AND NEW AUTEL BLE



MX-SENSOR BLE

AVAILABLE FOR PURCHASE
SEPARATELY P/N: 300100

MX-SENSOR 1-SENSOR

AVAILABLE FOR PURCHASE
SEPARATELY P/N: 1SENSOR



ALL SYSTEMS DIAGNOSTICS



BI-DIRECTIONAL ACTIVE TESTS



PRE/POST-SCAN REPORTS



CLOUD-BASED REPORT SHARING



AUTEL ACADEMY TECHNICAL TRAINING

Visit autel.com/us/academy and register today for hands on automotive diagnostic, repair, service, and ADAS instruction.

AUTEL®

TPMS TRANSMITTERS, TOOLS & ACCESSORIES

AUTEL

AUTEL MAXI TPMS WIFI TOOL & (16) 1-SENSORS



- 4 programming methods
- Free updates for the life of the tool
- Exclusive TPMS status screen
- Change placard value (domestics)
- OBD relearn on domestics
- Exclusive copy by OBD
- Update via WI-FI

AUTEL TPMS TOOL/SENSOR KIT CONTAINS:

- TS508 TPMS Tool
- 16 MX-Sensors w/ Rubber Stems
- 4 Metal Valve Stems
- OBDII Cord
- Charging Cord
- Magnet
- User Manual
- Blow Molded Case

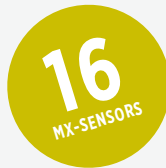

Ascot No.	Mfg. No.	Description
469-50816	TS508WFK-16	Maxi TPMS WIFI Tool & 16 MX-Sensor Kit

AUTEL ITS600 MAXI TPMS DIAGNOSTIC TOOL

- **New tablet style TPMS tool**
- Optical scanner identifies VIN/MMY
- Exclusive TPMS status screen
- Fast OBD II relearn for most US domestic vehicles
- Copy by OBD sensor programming for faster service
- **Batch program up to 20 Autel 1-Sensors**
- Activate, read, relearn all known TPMS sensors
- **Wireless OBDII connection via Bluetooth VCI**
- Tire pressure placard value reset
- Read/clear codes & view all system live data (with Pro Upgrade)
- Includes 4 commonly used maintenance service
- **FREE Wi-Fi software updates for the life of the tool**
- **5.5" Touchscreen (1280 x 720) / Android 9.0 / 8MP camera**

469-50816

Autel Maxi TPMS WiFi Tool & 16 MX-Sensor Kit

Ascot No.	Mfg. No.	Description
469-60000	ITS600	Autel ITS600 Maxi TPMS Diagnostic Tool



454-00200

Autel TBE200 MaxiTPMS Tread Depth Measurement Tool

Tool with included calibration plate shown to the left

Tool only shown above

AUTEL TBE200 TREAD DEPTH MEASUREMENT TOOL

- 1.65" AMOLED super retina touchscreen
- 1 Megapixel Macro Camera, 8 Megapixel Zoom Camera
- Tire Tread Depth/ Brake Disc Wear Measurement
- No Need To Remove The Wheel During Measurement
- Laser Measurement with 0.1mm Accuracy
- Real-Time Measurement Data on Touchscreen
- Full Tread Measurement / Quick Check
- Measurement Data Curve Display/ Uneven Wear Analysis
- Detailed Replacement & Maintenance Suggestions
- Test Detail For Single Tire Tread / Brake Disc
- Tire Expiration Notice / Tire Recall Lookup / Scan DOT (COMING SOON)
- Take Photos of Tire Wear & Damage
- Calibration Plate Included
- Compatible with Autel ITS600

Ascot No.	Mfg. No.	Description
454-00200	TBE200	Autel TBE200 MaxiTPMS Tread Depth Measurement Tool



TPMS TRANSMITTERS, TOOLS & ACCESSORIES



469-51812
Maxi TPMS Wifi/Sensor
Kit W/ 12 Sensors

MAXI TPMS WIFI/SENSOR KIT W/ 12 SENSORS

- The MaxiTPMS® TS508 is a new generation TPMS diagnostic & service tool specially designed to activate all known TPMS sensors, read TPMS sensor status, check TPMS system health condition, program MX-sensor status, check TPMS

- system health condition, program MX-sensors and conduct TPMS relearn
- With quick mode and advanced mode options, you can save time and energy by choosing the most suitable way to complete TPMS work
- Update via Wifi

KIT CONTAINS:

- TS508 Wifi TPMS tool
- 12 MX-sensors w/ rubber stems
- 4 Metal valve stems
- OBDII cord
- Charging cord
- Magnet
- User Manual
- Blow molded case



Ascot No.	Mfg. No.	Description
469-51812	TS508WFK 12ASC	Maxi TPMS Wifi/Sensor Kit W/ 12 Sensors



461-30326
Ascot TPMS Sensor
W/ Rubber Valve



ASCOT TPMS SENSOR W/RUBBER VALVE

- Combines 315MHz & 433MHz frequencies into a single sensor
- 99% vehicle coverage
- The exclusive MX-Sensor patented PRESS release valve allows rubber and metal valve stems to freely interchange by hand without requiring a tool
- Built to match or exceed OEM sensors in frequency strength and durability
- 100% ID clone-able with no relearn required
- Quickly update during installation with an Autel wireless programming tool

Ascot No.	Mfg. No.	Description
461-30326	1-Sensor-ASC	Ascot TPMS Sensor W/ Rubber Valve



461-30327
Ascot TPMS Sensor
W/ Metal Valve



ASCOT TPMS SENSOR W/METAL VALVE

- Combines 315MHz & 433MHz frequencies into a single sensor
- 99% vehicle coverage
- The exclusive MX-Sensor patented PRESS release valve allows rubber and metal valve stems to freely interchange by hand without requiring a tool
- Built to match or exceed OEM sensors in frequency strength and durability
- 100% ID clone-able with no relearn required
- Quickly update during installation with an Autel wireless programming tool

Ascot No.	Mfg. No.	Description
461-30327	1-Sensor-M-ASC	Ascot TPMS Sensor W/ Metal Valve

TPMS TRANSMITTERS, TOOLS & ACCESSORIES



ASCOT TPMS SENSOR W/ RUBBER VALVE (24 PACK)

- Combines 315MHz & 433MHz frequencies into a single sensor
- 99% vehicle coverage
- The exclusive MX-Sensor patented PRESS release valve allows rubber and metal valve stems to freely interchange by hand without requiring a tool
- Built to match or exceed OEM sensors in frequency strength and durability
- 100% ID clone-able with no relearn required
- Quickly update during installation with an Autel wireless programming tool

461-30329
Ascot TPMS Sensor W/
Rubber Valve (24 Pack)



Ascot No.	Mfg. No.	Description
461-30329	1-Sensor-24-ASC	Ascot TPMS Sensor W/ Rubber Valve (24 Pack)

ASCOT TPMS SENSOR W/RUBBER VALVE BULK PACKS

- Combines 315MHz & 433MHz frequencies into a single sensor
- 99% vehicle coverage
- The exclusive MX-Sensor patented PRESS release valve allows rubber and metal valve stems to freely interchange by hand without requiring a tool
- Built to match or exceed OEM sensors in frequency strength and durability
- 100% ID clone-able with no relearn required
- Quickly update during installation with an Autel wireless programming tool



461-30331
Ascot TPMS Sensor W/
Rubber Valve (480 Pack)

Ascot No.	Mfg. No.	Description
461-30331	1-Sensor-480-ASC	Ascot TPMS Sensor W/ Rubber Valve (480 Pack)
461-30328	1-Sensor-240-ASC	Ascot TPMS Sensor W/ Rubber Valve (240 Pack)

TPMS TRANSMITTERS, TOOLS & ACCESSORIES



461-30100
Pre-Programmed Tesla Bluetooth TPMS Sensor

PRE-PROGRAMMED TESLA BLUETOOTH TPMS SENSOR

- The MX-Sensor BLE is a pre-programmed Bluetooth Low Energy (BLE) sensor that offers "fit & go" capability for Tesla 3/Y/S/X models
- Built to meet or exceed industry standards and tested to endure extreme temperatures, the MX-Sensor BLE is also programmable with Autel tools for the latest BLE-equipped vehicles
- The MX-Sensor BLE features adjustable valve stems available in black, chrome, and gray to meet various vehicle needs and styles
- **The MX-Sensor BLE is warranted for two years**



Ascot No.	Mfg. No.	Description
461-30100	MX-Sensor BLE	Pre-Programmed Tesla Bluetooth TPMS Sensor

461-20326
Autel MX-Sensor Programmable TPMS Single Sensor



461-20327
Autel MX-Sensor Programmable Universal TPMS Sensor with Metal Stem

AUTEL MX-SENSOR PROGRAMMABLE UNIVERSAL TPMS SINGLE SENSORS

- Combines 315MHz & 433MHz frequencies into a single sensor
- 98% vehicle coverage
- The exclusive MX-Sensor patented PRESS release valve allows rubber and metal valve stems to freely interchange by hand without requiring a tool
- Built to match or exceed OEM sensors in frequency strength and durability
- 100% ID clone-able with no relearn required
- Quickly update during installation with an Autel wireless programming tool

Ascot No.	Mfg. No.	Description
461-20326	1-Sensor	Autel MX-Sensor Programmable Universal TPMS Single Sensor
461-20327	1-Sensor-M	Autel MX-Sensor Programmable Universal TPMS Sensor with Metal Stem
461-20328	1-Sensor-240	Autel MX-Sensor w/ Rubber Valve - 240 Bulk Pk.
461-20329	1-Sensor-24	Autel MX-Sensor w/ Rubber Valve - 24 Bulk Pk.
461-20331	1-Sensor-M-480	Autel MX-Sensor w/ Rubber Valve - 480 Bulk Pk.



461-20331
Autel MX-Sensor 480 Bulk Pk.

AUTEL MX-SENSOR REPLACEMENT RUBBER VALVE STEM

- Patented PRESS release valve design
- No valve tools required
- Simply click in and press out
- *Cap and core included*

Ascot No.	Mfg. No.	Description
469-20280	RV1000	Autel MX-Sensor Replacement Rubber Valve Stem



469-20280
Autel MX-Sensor Replacement Rubber Valve Stem

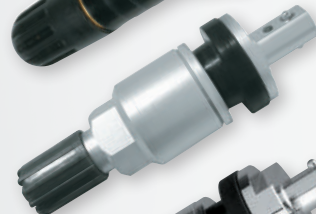

469-20279
Autel MX-Sensor Replacement Metal Valve

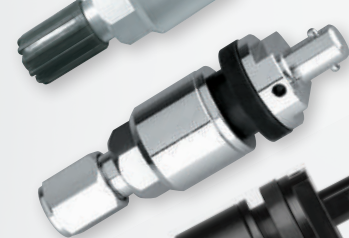

469-20283
Autel MX-Sensor Replacement Chrome TPMS Valve



469-20281
Autel Black MX-Sensor Replacement Metal Valve

AUTEL MX-SENSOR REPLACEMENT METAL VALVES

- Patented PRESS release valve design
- No valve tools required
- Simply click in and press out
- *Cap and core included*

Ascot No.	Mfg. No.	Description
469-20279	MV1000	Autel MX-Sensor Replacement Metal Valve
469-20281	CV-001	Autel Black MX-Sensor Replacement Metal Valve
469-20282	CV-002	Autel Titanium Grey MX-Sensor Replacement Metal Valve
469-20283	CV-003	MX-Sensor Chrome Replacement TPMS Valve

TPMS TRANSMITTERS, TOOLS & ACCESSORIES

AFTERMARKET TPMS ACCESSORY KITS

Ascot No.	Mfg. No.	Description
468-17492	17-492L-1	Long Skirted Black Plastic Cap with Seal for 17-20008
469-17107	17-20107AK	TPMS Parts Kit for GM Applications
469-17208	17-20008	GM TPMS Rubber Snap-In Valve
469-17213	17-20013AK	TPMS Parts Kit for Dodge, Jeep, Chrysler Applications
469-17216	17-20016AK	TPMS Parts Kit for Mercedes, Smart Applications
469-17218	17-20018	TPMS Ford Rubber Snap-In Valve
469-17221	17-20201AK	TPMS Parts Kit for Chrysler, GM Applications
469-17222	17-20202AK	TPMS Parts Kit for Audi, Mercedes, Volkswagen Applications
469-17223	17-20203AK	TPMS Parts Kit for Audi, Mercedes Application
469-17224	17-20204AK	TPMS Parts Kit for Acura, Honda, Kia Applications
469-17226	17-20206AK	TPMS Parts Kit for Hyundai, Honda, Kia Applications
469-17228	17-20028AK	TPMS Parts Kit for Chrysler, Dodge, Mitsubishi Applications
469-17272	17-20720AK	TPMS Parts Kit for Conti OE Sensors & Redi-Sensor
469-17275	17-20725AK	TPMS Service Kit with Valve
469-17296	17-20096AK	TPMS Parts Kit for Ford Applications
469-17311	17-20211AK	TPMS Parts Kit for Misc. Import Applications
469-17316	17-20216AK	TPMS Parts Kit for Lexus/Toyota Applications
469-17317	17-20217AK	TPMS Parts Kit for Lexus/Toyota Applications
469-17420	17-20020AK	TPMS Parts Kit + Stem for Chrysler, Dodge, Mercedes Applications
469-17539	17-50399	TPMS Snap-In Valve, Hyundai



469-17208
GM TPMS Rubber Snap-in Valve



469-17275
TPMS Service Kit with Valve

AUTEL TIRE PRESSURE PLACARD VALUE STICKER

- Never set tire pressure below OE Specs
- Always use equal to or greater than load rating on replacement tire to determine proper air pressure for placard
- Always complete and install a new tire placard properly marked
- **QUANTITY:** 100 per roll



469-20284
Autel Tire Pressure Placard Value Sticker

Ascot No.	Mfg. No.	Description
469-20284	PVS01	Autel Tire Pressure Placard Value Sticker (100 per Roll)

TPMS TRANSMITTERS, TOOLS & ACCESSORIES



461-33560
Schrader EZ-Sensor® GO



FASTEST
PROGRAMMABLE
SENSOR



461-33500
Schrader Dual
Band EZ-Sensor®



461-33700
High Speed
Clamp-In Dual
Band EZ-Sensor



461-59387



461-59357



SCHRADER EZ-SENSOR® GO

- Instantaneous 1 second programming for domestic vehicle applications
- 3-5 second programming speed for import vehicle applications
- Available mechanical packages include silver adjustable angle clamp-in, matte black adjustable angle clamp-in, and rubber snap-in
- Sleek blue cap
- Compatible with most tools on the market
- Combines 314.9, 315 & 433 MHz equipped vehicles
- Covers 99.90% of TPMS
- Meets OE quality and replicates OE functionalities

Ascot No.	Mfg. No.	Description
461-33560	33560	Schrader EZ-Sensor® GO TPMS Sensor
461-33561	33560M	Schrader EZ-Sensor® GO - 220 Bulk Pack
461-33562	33560-24	Schrader EZ-Sensor® GO - 24 Bulk Pack

SCHRADER DUAL BAND EZ-SENSOR®

- Combines 314.9, 315 and 433 applications into ONE sensor
- Future proofed to support new and pending OE system technologies
- Increases speed, ensures accuracy and reduces the cost of servicing TPMS-equipped vehicles
- Replicates OE functionality, including auto-locate technology
- Aluminum clamp-in and rubber snap-in stem options
- Fully programmable to the selected vehicle type
- Covers majority of TPMS equipped vehicles
- Works with many programming tools
- Achieves OE quality requirement

Ascot No.	Mfg. No.	Description
461-33500	33500	Schrader Dual Band EZ-Sensor®

HIGH SPEED CLAMP-IN DUAL BAND EZ-SENSOR®

- 314.9, 315 and 433 MHz
- Adjustable, aluminum stem
- OE validated to 200 MPH
- 115 PSI

Ascot No.	Mfg. No.	Description
461-33700	33700	High Speed Clamp-In Dual Band EZ Sensor®

TPMS VALVE INSERTS

- Original equipment valve insert for the Beru Tire Safety System
- Each Insert comes complete with cap, core, grommet & grommet nut
- Colored bottom to differentiate inserts
- **APPLICATIONS:** Audi, Bentley, BMW, Ferrari, Land Rover, Maserati, Maybach, Mercedes-Benz, Porsche, Volkswagen
- *Requires TX-20EZ torx tool for assembly / disassembly*

Ascot No.	Mfg. No.	Description
461-59357	59.0346	Orange Valve Insert
461-59387	59.0344	Black Valve Insert

TPMS TRANSMITTERS, TOOLS & ACCESSORIES

Tool only shown below

SCHRADER EZ SENSOR®/TOOL BUNDLE

- New S41 (21298) model replaces the S46 (21290)
- Offers functionality and flexibility at an affordable price
- Simple and easy-to-use interface guides the user when replacing and servicing TPMS sensors
- With the addition of the OBD Quick Connector, users can reset the ECU in less than 2 minutes
- Frequently updated with new features and up-to-date vehicle and sensor coverage

SCHRADER EZ-SENSOR® BUNDLE CONTAINS:

- (24) Schrader EZ- Sensors®
- ATEQ S41 TPMS Scan Tool
- OBDII cable

Ascot No.	Mfg. No.	Description
469-21298	21298	SCHRADER EZ SENSOR®/TOOL BUNDLE: 24 EZ-Sensors plus Programming and Diagnostic Tool

24
EZ-SENSORS

469-21298
Schrader EZ Sensor/Tool Bundle



TOP SELLER



www.ascotsupply.com

⚠️ WARNING: For more information go to www.P65Warnings.ca.gov.

EZ-sensor Always Ahead

The Market's Fastest Programmable TPMS Sensor

Maximize Productivity with Parallel Sensor Programming



Efficient Programming:

Simultaneously program sets of two to four TPMS sensors, reducing downtime

Copy-Paste for Rapid Configuration:

Enable technicians to quickly duplicate old sensor settings, ensuring efficient TPMS service

Instant Sensor Programming:

1-3 second programming for the majority of vehicles

PN 33560



TPMS VALVE CAP W/ SEALS

- Grey cap for clamp-in TPMS sensors
- Keeps moisture and dirt out of the electronic sensor
- Ensures that the primary seal exists to avoid air leakage
- 100 per package

Ascot No.	Mfg. No.	Description
468-74920	A17-492T-1	Grey Plastic TPMS Valve Cap W/ Seal
468-74921	A17-492L-1	Long Black TPMS Cap W/ Seal

LARGE BORE HEX VALVE CAP

- Fits .482-26 valve threads
- Made from brass
- 10 caps per bag
- Similar to Haltec A-149 (TRVC7)
- **Made in China**

Ascot No.	Mfg. No.	Description
468-00149	VC7	Large Bore Hex Valve Cap

ALLIGATOR V2B DUAL SEAL CAP



- Made in Germany by Alligator
- Increased tire life
- Lower fuel consumption
- Safety for driver and vehicle

Ascot No.	Mfg. No.	Description
468-02222	V2B	Alligator V2B Dual Seal Cap

HALTEC DS-1 DOUBLE SEAL CAP

- Reduce pressure check time by 65%
- Inflate, deflate or gauge directly through the DS-1
- Features tough all metal housing, precision fit brass components and durable self-sealing O-Ring
- Automatic inflation systems lock right onto the DS-1
- Performs like a check valve, the seal becomes tighter in the event of a core failure
- Heat resistant grommets provide additional protection

Ascot No.	Mfg. No.	Description
468-04191	DS-1	Haltec Double Seal Cap

METAL DOME VALVE CAP

- 100 per box
- Nickel-plated brass
- Seal included
- Fits standard bore valves
- Compatible with 0.307-32 threads
- Low profile
- Similar to Haltec VC-3 & Dill 765
- **Made in China**

Ascot No.	Mfg. No.	Description
468-01765	AS-VC3	Metal Dome Valve Cap

VALVE CAPS

- All valve caps are packaged 100 per box

Ascot No.	Mfg. No.	Description
468-00107	CAP P	Plastic Valve Cap
468-00207	Cap PG	Green Plastic Valve Cap
468-00050	20395	TPMS Plastic Sealing Valve Cap
468-20495	20495	TPMS Aluminum Sealing Valve Cap
468-20595	20595	Black TPMS Plastic Sealing Valve Cap
468-59019	59-0019	Green Nitrogen Indicating Aluminum Valve Cap
468-59021	59-0021	Chrome Plated Nitrogen Indicating Brass Valve Cap

REPLACEMENT GROMMETS

Ascot No.	Mfg. No.	Description
468-10015	RG-15	5/8" Hole (for TR570)
468-10046	RG-46	5/8" Hole (for TR509 and TR510)
468-00202	RN-02	Rim Hole Reducer

TPMS TRANSMITTERS, TOOLS & ACCESSORIES

NEW

468-74920
Grey Plastic TPMS Valve Cap W/ Seal



468-74921
Long Black TPMS Valve Cap W/ Seal

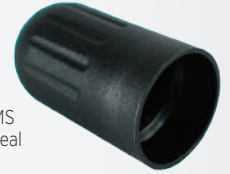

NEW

468-00149
Large Bore Hex Valve Cap



468-02222
V2B Dual Seal Cap



468-04191
Haltec DS-1 Double Seal Cap



468-00050
TPMS Plastic Sealing Valve Cap



468-20595
Black TPMS Plastic Sealing Valve Cap



468-00207
Green Plastic Valve Cap



468-20495
TPMS Aluminum Sealing Valve Cap



468-59019
Green Nitrogen Indicating Aluminum Valve Cap



468-01765
Metal Dome Valve Cap

NEW

468-59021
Chrome Plated Nitrogen Indicating Brass Valve Cap



468-00202
Rim Hole Reducer



468-10015



468-10046

TPMS TRANSMITTERS, TOOLS & ACCESSORIES



NEW

468-09002
Nickel Plated High-Temp Valve Cores

NICKEL PLATED HIGH-TEMP VALVE CORES

- Nickel plated for use with aluminum TPMS valves
- Temperature rated up to 150 degrees
- 100 Per Box
- **Made In China**



Ascot No.	Mfg. No.	Description
468-09002	9002	Nickel Plated Valve Cores



468-20055
Electro-Less Nickel Plated Valve Cores

ELECTRO-LESS NICKEL PLATED VALVE CORES

Ascot No.	Mfg. No.	Description
468-20055	20055	Electro-Less Nickel Plated Valve Cores

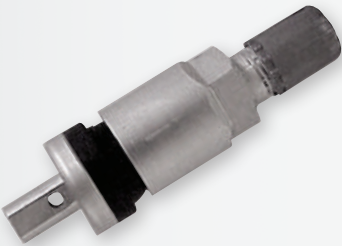

469-00925
Dill Aluminum Replacement TPMS Stem

DILL ALUMINUM REPLACEMENT TPMS STEM

- Metal Replacement Clamp-In Valve for GM, Ford, Dodge Ram, Subaru & Suzuki
- Made from anodized aluminum
- *T-10 screw included*
- **QUANTITY:** Packaged 20 per box

Ascot No.	Mfg. No.	Description
469-00925	VS-925A	Dill Aluminum Replacement TPMS Stem



469-00950
GM & Ford Replacement TPMS Snap-In Valve

DILL GM & FORD REPLACEMENT TPMS SNAP-IN VALVE

- Snap-In valve replacement for both GM & Ford TPMS applications
- Can be used to replace both the Schrader 20008 & 20018
- *Includes a long black sealing cap and T-10 screw*
- *Requires T-10 torx tool for assembly/disassembly*
- **QUANTITY:** Packaged 25 per box

Ascot No.	Mfg. No.	Description
469-00950	VS-950	Dill Rubber Snap-In Replacement Valve for GM & Ford Transmitters

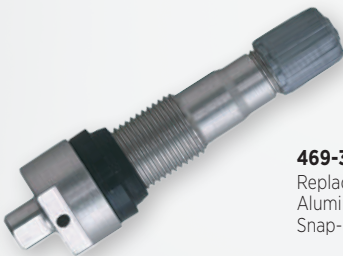

469-34000
Replacement Aluminum Snap-In Valve

REPLACEMENT ALUMINUM VALVE STEM

Ascot No.	Mfg. No.	Description
469-34000	34000	Replacement Aluminum Valve Stem

TPMS TRANSMITTERS, TOOLS & ACCESSORIES

REPLACEMENT TPMS VALVE STEM

- Snap-In valve replacement for both GM & Ford TPMS applications
- Includes a long black sealing cap and T-10 screw
- Requires T-10 torx tool for assembly/disassembly
- Similar to 31 Inc. 17-20008, Schrader 20018, Dill VS-950
- 100 Per Bag/500 per box
- **Made in China**

Ascot No.	Mfg. No.	Description
469-00208	AS2008	Replacement TPMS Valve Stem

469-00208
Replacement TPMS Valve Stem



REPLACEMENT TPMS SNAP-IN VALVE

- Rubber stem and attaching screw for Schrader snap-in sensors
- Requires T-10 torx tool for assembly/disassembly
- *Cap & core included*
- *For use with Schrader EZ Sensors*
- **QUANTITY:** Packed 50 per box

Ascot No.	Mfg. No.	Description
469-20018	20018	Replacement Snap-In Valve for Schrader Snap-In Sensors

469-20018
Ford Replacement TPMS Snap-In Valve



TPMS REPLACEMENT VALVE WITH PRE-THREADED INSIDE HOLE

- For GM, Ford, Chrysler/Dodge/Jeep and more
- T10 screw included - torque 11.5 in/lbs (1.3Nm)
- Sold in bags of 100
- Maximum cold inflation pressure 65 psi

Ascot No.	Mfg. No.	Description
469-17538	17-50388-100	TPMS Replacement Valve with Pre-Threaded Inside Hole

469-17538
TPMS Replacement Valve w/ Pre-Threaded Inside Hole



TPMS REPLACEMENT VALVE W/ HYBRID KEY

- Combines PARALLEL and RIGHT ANGLE keys
- For GM, Ford
- T10 stepped screw included - torque 11.5 in/lbs (1.3Nm)
- Sold individually
- Maximum cold inflation pressure 65psi

Ascot No.	Mfg. No.	Description
469-17389	17-50389	TPMS Replacement Valve with Hybrid Key

469-17389
TPMS Replacement Valve w/ Hybrid Key



HIGH-SPEED GM TPMS SNAP-IN VALVE STEM

- Self-tapping screw
- Parallel key
- 11.5 in./lb. screw torque
- 80 PSI maximum cold inflation pressure
- **QUANTITY:** 10 per box, 240 per case

Ascot No.	Mfg. No.	Description
469-17245	17-20045	High-Speed GM TPMS Snap-In Valve Stem

469-17245
High-Speed GM TPMS Snap-In Valve Stem



TPMS TRANSMITTERS, TOOLS & ACCESSORIES



469-17395
TRW Snap-In
Sensor Rubber
Valve Stem
(Square Key)

469-17246
TPMS Snap-In
Valve Stem (Right
Angle Key)

469-17397
Continental
Snap-In
Sensor Rubber
Valve Stem

469-17539
Hyundai TPMS
Snap-In Valve

469-17392
TPMS
Replacement
Valve for .625"
Valve Hole
(Parallel Key)

469-17393
TPMS Replacement
Valve for .625" Valve
Hole (Square Key)

469-17398
Short TPMS
Replacement
Snap-In Valve
Stem

TPMS SNAP-IN VALVE STEM (RIGHT ANGLE KEY)

- Self-tapping screw
- Right angle key
- 11.5 in./lb. screw torque
- 80 PSI maximum cold inflation pressure
- **QUANTITY:** 10 per box, 240 per case

Ascot No.	Mfg. No.	Description
469-17246	17-20046	TPMS Snap-In Valve Stem (Right Angle Key)

TRW SNAP-IN SENSOR RUBBER VALVE STEM (SQUARE KEY)

- Self-tapping screw
- Square key
- 11.5 in./lb. screw torque
- 80 PSI maximum cold inflation pressure
- **QUANTITY:** 10 per box, 240 per case

Ascot No.	Mfg. No.	Description
469-17395	17-50395	TRW Snap-In Sensor Rubber Valve Stem (Square Key)

CONTINENTAL SNAP-IN SENSOR RUBBER VALVE STEM

- Clip lock
- 80 PSI maximum cold inflation pressure
- **QUANTITY:** 10 per box, 240 per case

Ascot No.	Mfg. No.	Description
469-17397	17-50397	Continental Snap-In Sensor Rubber Valve Stem

HYUNDAI TPMS SNAP-IN VALVE

- Lock nut
- 80 PSI maximum cold inflation pressure
- **QUANTITY:** 10 per box, 240 per case

Ascot No.	Mfg. No.	Description
469-17539	17-50399	Hyundai TPMS Snap-In Valve

.625" VALVE HOLE TPMS REPLACEMENT VALVES

- Found on Ford Super Duty Trucks and Sprinter Vans
- **MAXIMUM COLD INFLATION**
- **PRESSURE:** 150 PSI
- *Attachment screw and valve cap included*

Ascot No.	Mfg. No.	Description
469-17392	17-50392	TPMS Replacement Valve for .625" Valve Hole (Parallel Key)
469-17393	17-50393	TPMS Replacement Valve for .625" Valve Hole (Square Key)

SHORT TPMS REPLACEMENT SNAP-IN VALVE STEM

- Found on custom wheel applications
- Addresses clearance issues with inside valve holes
- **MAXIMUM COLD INFLATION PRESSURE:** 65 PSI
- Parallel key

Ascot No.	Mfg. No.	Description
469-17398	17-50398	Short TPMS Replacement Snap-In Valve Stem

TPMS TRANSMITTERS, TOOLS & ACCESSORIES

COMPLETE REPLACEMENT KIT FOR CHRYSLER/DODGE TPMS APPLICATIONS

COMPLETE REPLACEMENT KIT INCLUDES THE FOLLOWING:

- Aluminum TPMS Valve Stem w/ Grommet
- Valve Core
- Valve Cap
- Valve Nut

Ascot No.	Mfg. No.	Description
469-90660	9066-K	Dill Chrysler TPMS Complete Stem Replacement Kit

469-90660
Complete Replacement Kit for Chrysler/Dodge Applications

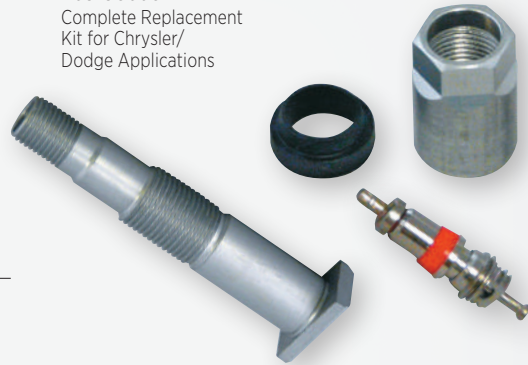

T-10 TORQUE TOOL

Ascot No.	Mfg. No.	Description
469-20140	20140	T-10 Torque Tool for Snap-In Transmitters

469-20140
T-10 Torque Tool for Snap-In Transmitters



T-10 TORQUE TOOL WITH REPLACEABLE TIP

- Installs replacement snap-in valves to Schrader snap-in transmitters
- Preset to 12 in./lb.

Ascot No.	Mfg. No.	Description
469-15415	15415	T-10 Torque Tool w/ Replaceable Tip
469-25415	15415-1	Replacement T-10 Tip

469-15415
T-10 Torque Tool with Replaceable Tip



469-15535
T-20 Torque Tool with Replaceable Tip

T-20 TORQUE TOOL WITH REPLACEABLE TIP

- Installs replacement Beru snap-in valves
- Preset to 35 in./lb.

Ascot No.	Mfg. No.	Description
469-15535	15535	T-20 Torque Tool w/ Replaceable Tip
469-25535	15535-1	Replacement T-20 Tip

PRESET VALVE NUT TORQUE WRENCHES

- Wrench flexes when proper torque setting is reached
- Cushioned handle
- Prevents overtightening of the valve grommet
- Sizes and preset torque settings laser etched on shaft
- +/- 4% accuracy

Ascot No.	Mfg. No.	Description
168-00058	NSPTW58	5/8" Preset Torque Wrench for TR540-550 Series Valve Hex Nuts
168-00916	NSPTW916	9/16" Preset Torque Wrench for TR570 Series Valve Hex Nuts

168-00058
5/8" Preset Torque Wrench Calibrated

168-00916
9/16" Preset Torque Wrench Calibrated



TPMS TRANSMITTERS, TOOLS & ACCESSORIES



PROFESSIONAL TPMS MECHANICAL TOOL KIT

TPMS MECHANICAL TOOL KIT INCLUDES THE FOLLOWING:

- 1/4" Torque Screwdriver 10-80 in./lbs.
- Torque Valve Screwdriver 4 in./lbs.
- 2 Sockets: 11mm & 12mm
- 1/4" Adapter
- 4 Bits: T5, T10, T15 & T20
- Grommet Tool

469-10110
TPMS Mechanical Tool Kit

Ascot No.	Mfg. No.	Description
469-10110	TPMKT010	TPMS Mechanical Tool Kit

TPMS MECHANICAL TOOL KIT CONTENTS

Ascot No.	Mfg. No.	Description
469-10415	TPMKT015-4	TPMS Valve Core Torque Tool
469-10715	TPMKT015-7	Multi-Purpose TPMS Grommet Tool

TPMS CHROME FLIP SOCKET/EXTENSION KIT

- 1/4" drive 11mm x 12mm chrome flip socket
- 1/4" drive x 2" chrome extension
- Unique flip socket design is the key to the easy installation and removal of TPMS sensors
- Both pieces made of chrome vanadium

167-01012
TPMS Chrome Flip Socket/ Extension Kit

Ascot No.	Mfg. No.	Description
167-01012	TMRTR1012	TPMS Chrome Flip Socket/ Extension Kit

TPMS CHROME FLIP SOCKET/SOCKET DRIVER KIT

- 1/4" drive 11mm x 12mm chrome flip socket
- 1/4" drive screwdriver handle socket driver - 6" overall length - 2-1/2" shank length
- Unique flip socket design is the key to the easy installation and removal of TPMS sensors
- Socket is made of chrome vanadium
- Socket driver is made in the USA

167-01015
TPMS Chrome Flip Socket/ Socket Driver Kit

Ascot No.	Mfg. No.	Description
167-01015	TMRTR1015	TPMS Chrome Flip Socket/Socket Driver Kit

TPMS 1/4" DRIVE IMPACT SOCKETS

- CR-MO alloy steel for long life
- Radius corner design assists socket in grabbing the flat side of the fastener

Ascot No.	Mfg. No.	Description
167-12110	1211D	1/4" Drive 11 mm x 12mm Chrome Flip Socket
169-01002	1002E	1/4" Drive x 2" Chrome Extension

TPMS BAND TRANSMITTER ACCESSORIES

- TPMS Band is adjustable to accommodate 14" - 26" wheels
- For use on vehicles equipped with banded transmitters

Ascot No.	Mfg. No.	Description
469-01426	TPSTRAP	14" - 26" Adjustable Band for Banded TPMS Sensors



167-12110
1/4" Drive 11 mm x 12mm Chrome Flip Socket

169-01002
1/4" Drive x 2" Chrome Extension

469-01426
Adjustable Band for Banded TPMS Sensors

TPMS TRANSMITTERS, TOOLS & ACCESSORIES

SCHRADER TPMS ACCESSORY KITS

The OEM requires that the four sealing components be replaced when re-installing a TPMS sensor. The replacement components are supplied in TPMS accessory kits, which are sensor specific.

EACH TPMS ACCESSORY KIT CONTAINS:

- 1 Nut
- 1 Valve Core
- 1 Cap
- 1 Grommet

SCHRADER TPMS ACCESSORY KIT ASSORTMENT

Contains all the parts you will need when servicing tires and wheels that are equipped with Schrader Original Equipment pressure monitoring transmitter valves. All components are individually packaged for easy identification by vehicle application and are stored in a handy plastic box.

Ascot No.	Mfg. No.	Description
469-20598	20598	TPMS Service Pack Assortment. Includes: 8 each of service packs 20002, 20003, 20004, 20008, 20013, 20014, 20020, 20021, 20023, 20030, 20032 and 20036

Ascot No.	Mfg. No.	Description
469-20007	20007	Accessory Kit For Alloy Wheel Nissan Transmitters
469-20009	20009	Accessory Kit for Suzuki Replacement Transmitter
469-20013	20013	Accessory Kit for Dodge Nitro Transmitters
469-20014	20014	Accessory Kit for Nissan Transmitters
469-20017	20017	Accessory Kit for Volkswagen/Siemens Transmitters
469-20018	20018	Replacement Snap-In Valve Ford 20315 Transmitter, Box of 50
469-20019	20019	Accessory Kit for Honda/Acura Transmitters
469-20020	20020	TPMS Service Pack - Stem Only - Chrysler, Dodge, Jeep
469-20030	20030	Accessory Kit for Chrysler/Siemens Transmitters
469-20032	20032	Accessory Kit for Toyota/Pacific Transmitters
469-20035	20035	Accessory Kit for TRW Long Valve Transmitters
469-20036	20036	Accessory Kit for TRW Short Valve Transmitters



469-20598
Master Accessory Kit Assortment

ALLIGATOR UNIVERSAL METAL TPMS KIT

- Universal TPMS Service Kit for Metal Valve Stems ensures you choose the correct components corresponding to your specific TPMS sensor
- Works on 97% of metal valve stem TPMS sensors in the market
- Each kit includes a valve core, valve nut, valve cap, large grey seal, metal washer and small black seal
- Unused parts can be discarded
- Packaged 20 kits per box



469-22482
Alligator Universal Metal TPMS Kit

Ascot No.	Mfg. No.	Description
469-22482	U1	Alligator Universal Metal TPMS Kit

ALLIGATOR U2-BULK UNIVERSAL REPLACEMENT TPMS VALVE STEM

- Designed, manufactured and test-rated to outperform comparable OEM products
- ALLIGATOR TPMS Service Kits contain all components that are necessary the correct and thorough service
- Use only nickel-plated valve cores conjunction with TPMS valves
- Pre-threaded screw, long cap
- Bag of 50 bulk valves
- 300 valves per case – Sold case quantities only



469-91322
Alligator U2-Bulk Universal Replacement TPMS Valve Stems

Ascot No.	Mfg. No.	Description
469-91322	591320BC	Alligator U2-Bulk Universal Replacement TPMS Valve Stem - 50 Per Bag/300 Per Case

ALLIGATOR U2 UNIVERSAL REPLACEMENT TPMS VALVE STEM

- Designed, manufactured and test-rated to outperform comparable OEM products
- ALLIGATOR TPMS Service Kits contain all components that are necessary for the correct and thorough service
- Use only nickel-plated valve cores in conjunction with TPMS valves
- Pre-threaded screw
- Long cap
- Box of 20 valves



469-22481
Alligator U2 Universal Replacement TPMS Valve Stem

Ascot No.	Mfg. No.	Description
469-22481	U2	Alligator U2 Universal Replacement TPMS Valve Stem - Box of 20

TIRE VALVES

Tubeless Tire Valves (Truck)

TRUCK & BUS TUBELESS TIRE VALVES: 570 SERIES

- Used on both demountable and non-demountable rims with standard 5/8" (.625") side hole valve mountings
- Heavy duty rubber grommet forms airtight seal when valve is clamped in rim by tightening the hex nut
- Eight valves cover all truck rim requirements

Ascot No.	TR No.	Effective Length
463-00501	501	1-1/2"
463-00572	572	3-3/4"
463-00573	573	4-3/8"



463-00501



463-00572



463-00573

AIR/LIQUID VALVE: 1-7/8"

Ascot No.	TR No.	Effective Length
464-00618	618A	1"



464-00618



ALUMINUM WHEEL TRUCK TUBELESS TIRE VALVES: 540 & 550 SERIES

- Designed for use with 9.7mm (.382") rim hole
- Rubber O-ring forms a seal when valve is clamped to rim by tightening hex nut
- Designed specifically for use in aluminum wheels
- 550 Series equipped with rubber grommet

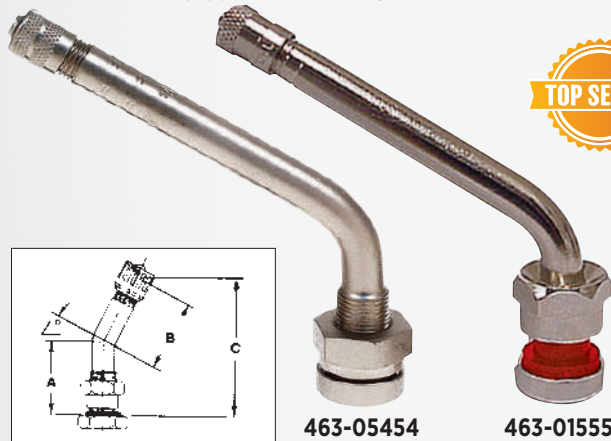

463-05454

463-01555



CLAMP-IN TIRE VALVES



Ascot No.	TR No.	Description
462-11147	ASN-1147	Radial Commander Valve
463-00500	TR500	Clamp-In Tire Valve for .625" Rim Hole - 2"
463-00575	TR575	Clamp-In Tire Valve for .625" Rim Hole - 1-1/8"
463-02554	TR554D	Aluminum Clamp-In Valve for .382" Rim Hole- 1.94"
463-05434	TR543D	Aluminum Clamp-In Valve for .382" Rim Hole- 1.38"
463-05435	TR543E	Aluminum Clamp-In Valve for .382" Rim Hole- 1.38"
463-05444	TR544D	Aluminum Clamp-In Valve for .382" Rim Hole- 1.94"
468-00203	TRCH-3	Core Housing

Ascot No.	TR No.	A	B	C
540 SERIES				
463-05454	545D	0.98"	2.60"	60°
550 SERIES				
463-01555	555D	0.98"	2.60"	60°

AIR - FLEXX® FLEXIBLE VALVE EXTENTIONS

- Entirely pressure free during operation
- Unbreakable. No risk of damaged extension or air loss
- Fitment without additional holder / clamp / stabilizer (up to air-flexx® length 215 mm)
- Always accessible. Air pressure checks can always be performed, without removing hubcaps
- Even load on all tires. Less tire wear
- Lower fuel consumption

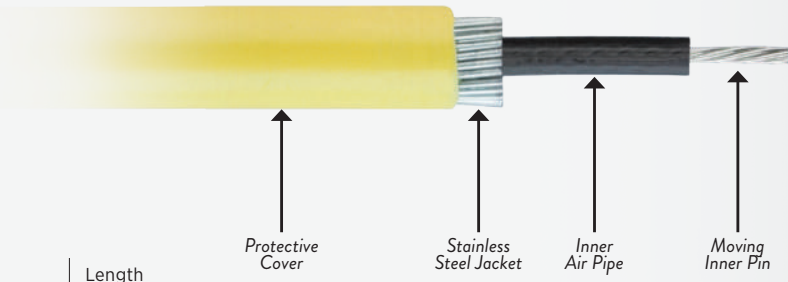

Ascot No.	Mfg. No.	Description	Length
468-00075	AF-0075-GE	w/ Cap - 75mm - 2-Pack	2-15/16"
468-00085	AF-0085-GE	w/ Cap - 85mm - 2-Pack	3-5/16"
468-00105	AF-0105-GE	w/ Cap - 105mm - 2-Pack	4-1/8"
468-00145	AF-0145-GE	w/ Cap - 145mm - 2-Pack	5-11/16"
468-00185	AF-0185-GE	w/ Cap - 185mm - 2-Pack	7-1/4"
468-00215	AF-0215-GE	w/ Cap - 215mm - 2-Pack	8-7/16"
468-00315	AF-0315-GE	w/ Cap - 315mm - 2-Pack	12-3/8"
468-00415	AF-0415-GE	w/ Cap - 415mm - 2-Pack	16-5/16"
468-01000	AF-1000-GE	w/ Cap - 1000mm - 2-Pack	39-3/8"



TIRE VALVES

Tubeless Tire Valves (Passenger)

SNAP-IN TUBELESS TIRE VALVES



Ascot No.	TR No.	EFFECTIVE LENGTH	BODY
FOR .453" VALVE HOLES			
461-00412	412	7/8"	Brass
461-00413	413	1-1/4"	Brass
461-00414	414	1-1/2"	Brass
461-01413	413A	1-1/2"	Aluminum
461-01414	414A	1-1/2"	Aluminum
461-01418	418A	2"	Aluminum
FOR .625" VALVE HOLES			
461-00415	415	1-1/2"	Brass

HIGH PRESSURE SNAP-IN VALVES

• Tubeless snap-in type valves for high pressure applications • Maximum cold inflation pressure is 80 PSI • For .453" or .625" rim holes • Do not use on tire rims that exceed .205" in thickness at the valve hole



461-00600

Ascot No.	TR No.	EFFECTIVE LENGTH	VALVE HOLE DIAMETER
461-00600	600HP	1.25"	.453"
461-00800	801HP	1.25"	.625"

CHROME-SLEEVE SNAP-IN TYPE TUBELESS TIRE VALVES

• Standard snap-in type tubeless tire valves are fitted with an attractively designed hexagon valve cap and chrome sleeve to cover the valve stem area



461-41311

Ascot No.	TR No.	EFFECTIVE LENGTH
461-41311	413SC	1-1/4"

TANK VALVE

• Utilized on pressure containers where gauging or servicing may be required • Tank valves are used with various gases, fluids and operating pressures • 1/8-27 NPT thread • Nickel plated • 100 per bag



468-00401

Ascot No.	TR No.	EFFECTIVE LENGTH
468-00401	SMTV03	1"

CLAMP-IN TUBELESS TIRE VALVES

• Nickel plated metal valves can be installed in all passenger cars, light trucks and industrial rims with .453" or .625" valve holes • Rubber grommet forms a seal when valve is clamped to rim by tightening hex nut • Maximum inflation pressure is 200 PSI • Includes 2 rubber grommets



462-00416

Ascot No.	TR No.	EFFECTIVE LENGTH
462-00416	416	1-1/4"

VALVE HARDWARE TOOLS & ACCESSORIES

VALVE INSTALLATION TOOL W/ RUBBER BLOCK

- Rubber block adds leverage during valve stem installation and removal
- Keeps valve stems in a vertical position during installation/removal
- Steel construction with knurled handle
- Flexible rubber block to protect the wheel

Ascot No.	Mfg. No.	Description
469-00014	VT-014	Valve Installation Tool w/ Rubber Block

VALVE STEM PULLER W/ RUBBER BOOT

- Rubber over mold to protect wheel & rim from possible damage while installing or removing valve stem
- Offset head designed to work with most after-market wheels & rims
- Locking head assembly enables easy installation and removal of valve stems
- Equivalent to ESCO 50114

Ascot No.	Mfg. No.	Description
469-00040	VIT-002	Valve Stem Puller w/ Rubber Boot

TUBELESS VALVE INSERTION/REMOVAL TOOL

- For all sizes of snap-in passenger car tire valves.

Ascot No.	Mfg. No.	Description
469-00992	992	Tubeless Valve Insertion/Removal Tool

TUBELESS TIRE VALVE SERVICE TOOL

- Pull-A-Stem tool pulls old valves or inserts new valves
- Fits all sizes or lengths

Ascot No.	Mfg. No.	Description
469-01124	VT-1124	Tubeless Tire Valve Service Tool

HEAVY DUTY PROFESSIONAL PLASTIC VALVE PULLER

- Steel tube reinforced handle provides extreme rigidity
- Safety orange color for easy visibility
- Indestructible
- Protects wheels from damage during installation/removal of snap-in valve stems
- **Made in Taiwan**

Ascot No.	Mfg. No.	Description
469-01638	1638A	Heavy Duty Professional Plastic Valve Puller

GREEN PLASTIC ECONOMY VALVE PULLER W/ METAL ROD INSERT

- Metal rod inserted through the puller for increased strength
- Made from a durable plastic material
- Will not scratch or mark aluminum wheels
- Locking head assembly enables easy installation and removal of valve stems
- Equivalent to ESCO 50117, AME 51170 & Dill 5407P

Ascot No.	Mfg. No.	Description
469-03333	VT-03P	Green Plastic Economy Valve Puller W/ Metal RodInsert

TIRE VALVE INSTALLER

- Ergonomic Handle
- Robust Design
- Durable Steel Construction
- Pivoting Head
- Threaded Head
- **Made In Taiwan**

Ascot No.	Mfg. No.	Description
469-00850	NS-79435L	Tire Valve Installer



VALVE HARDWARE TOOLS & ACCESSORIES



VALVE CORE REMOVERS

Ascot No.	Mfg. No.	Description
469-00001	CT-1	Pocket Size Valve Core Remover
469-00003	CT-3	Heavy Duty 1 3/4" Steel Shaft Valve Core Remover

LARGE BORE/STANDARD BORE VALVE CORE TOOL

Ascot No.	Mfg. No.	Description
469-00005	CT-5	Large Bore/Standard Bore Valve Core Tool

VALVE CORE TOOL - SCREWDRIVER TYPE

- Has a plastic screwdriver handle for better grip and leverage
- **Made in USA**

Ascot No.	Mfg. No.	Description
469-00607	607	Valve Core Tool - Screwdriver Type

LARGE BORE 4-WAY VALVE CORE TOOL

- Repairs damaged threads
- Removes damaged valve cores
- Fits large bore and super large bore valves
- Similar to Haltec TL-690 & Dill 5209L
- **Made in China**

Ascot No.	Mfg. No.	Description
469-01690	AS-690	Large Bore 4-Way Valve Core Tool

BLACK HEAT TREATED HEAVY DUTY TIRE VALVE REPAIR TOOL

- 4-In-1 standard valve tool repairs cap threads, repairs core threads
- Easy-out feature for removing damaged cores & standard caps

Ascot No.	Mfg. No.	Description
469-00002	CT-2	Black Heat Treated Heavy Duty Tire Valve Repair Tool

ECONOMY 4-WAY VALVE CORE TOOLS

Ascot No.	Mfg. No.	Description
469-00004	CT-4	Economy 4-Way Valve Core Tool
469-00012	CT-2E	Economy 4-Way Valve Core Tool - Black

LARGE BORE VALVE CORE TOOLS

- For use with large bore valves
- Equipped with sliding sleeve which holds the core during removal
- Sliding sleeve allows positive grip on valve core for those hard-to-reach valves
- Durable plastic handle
- 5.4" and 10" lengths
- **Made in China**

Ascot No.	Mfg. No.	Description
469-11610	ASN-1610	Large Bore Core Tool 5.4" Length
469-11710	ASN-1710	Large Bore Core Tool 10" Length

LARGE BORE HEX CAP TOOL

Ascot No.	Mfg. No.	Description
469-11810	ASN-1810	Large Bore Hex Cap Installation Remover Tool 10" Overall Length

LARGE BORE VALVE CORE REMOVER

Ascot No.	Mfg. No.	Description
469-11910	ASN-1910	Large Bore Core; Remover - 6"

VALVE HARDWARE TOOLS & ACCESSORIES

TIRE DEFLATOR/VALVE CORE REMOVER

- Screws on TPMS valve stems to deflate the tire without removing the valve core

Ascot No.	Mfg. No.	Description
469-00021	VT-21	Tire Deflator/Valve Core Remover

3-IN-1 EXTRACTOR & INFLATOR TOOL

- Use to remove valve cores, install valve cores, and inflate your tires with air. 1/4" threaded inlet
- Cut the valve cap installation process in half. Customized with air-holding seals to speed airflow through the tire valve
- Install air chuck onto tool, push knurled end inward, unscrew valve core. Pull knurled knob back, allowing core to be safely held inside of tool's air-tight chamber
- 5-1/8" length - 6-3/4" extended
- Valve core remains inside the tool so no more lost valve cores
- Similar to Milton S-443
- **Made in Taiwan**

Ascot No.	Mfg. No.	Description
469-00443	AS-443	3-In-1 Valve Extractor & Inflator Tool

LARGE BORE VALVE FISHING TOOL - CHAIN TYPE

- **Made in China**

Ascot No.	Mfg. No.	Description
469-00619	VT-01C-LB	Large Bore Valve Fishing Tool - Chain Type

CHAIN VALVE FISHING TOOL

- Guides valve smoothly through rim hole while mounting tire & tube

Ascot No.	Mfg. No.	Description
469-00609	609	Chain Valve Fishing Tool

CABLE VALVE FISHING TOOL

- Valve core wrench and deflating pin with flexible cable for fishing valve through rim hole

Ascot No.	Mfg. No.	Description
469-00011	VT-01	Cable Valve Fishing Tool

CABLE TYPE VALVE FISHING TOOL - 24"

- Combines valve core wrench and deflating pin with flexible cable for fishing valve through rim hole
- Cable type design
- 24" length
- Similar to Haltec TL-645-24
- Made in China

Ascot No.	Mfg. No.	Description
469-00024	VTC-018-24	Cable Type Valve Fishing Tool - 24"

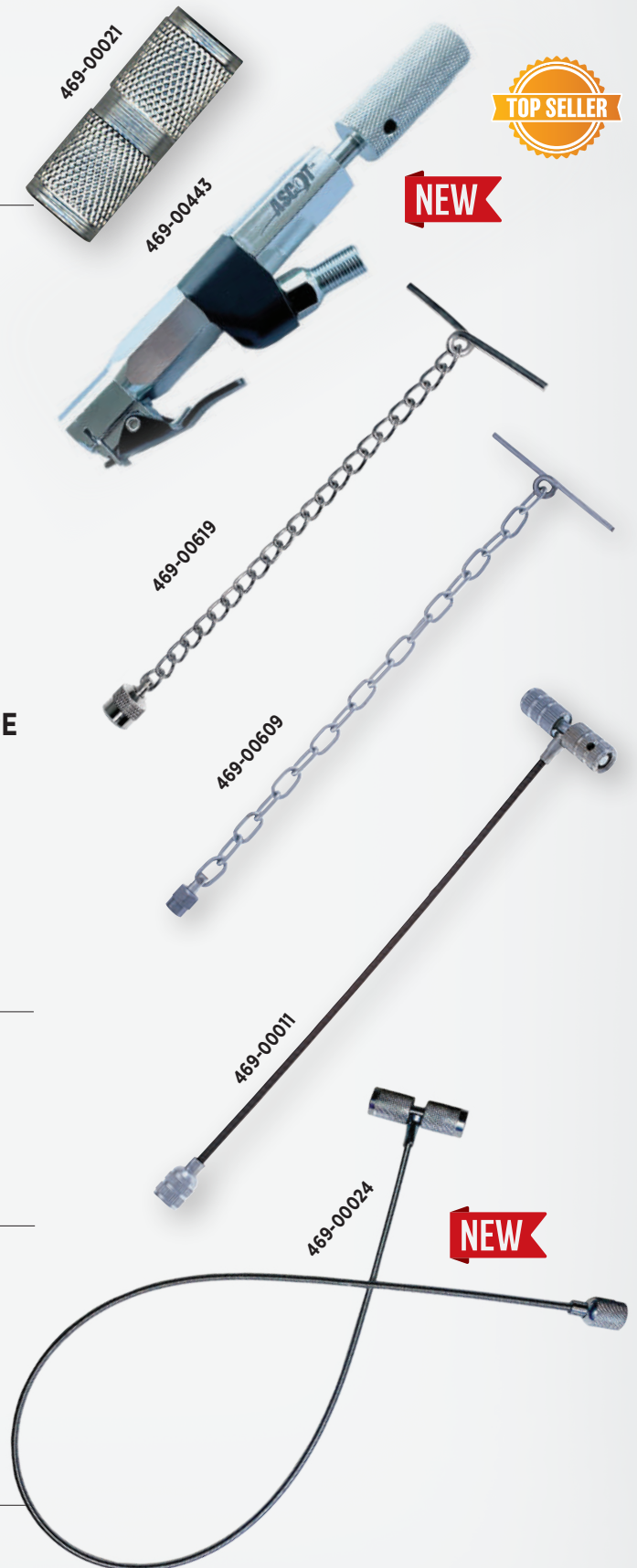

VALVE HARDWARE TOOLS & ACCESSORIES



469-51632
Tire Deflator Set

VALVE CORE TORQUE TOOL

- Preset torque guarantees correct setting every time on all cores
- Designed specifically for use with TPMS sensors
- Preset to 3-4 in./lbs.
- Can be used to install and remove cores in standard valves
- Similar to Dill 5414
- **Made in China**

Ascot No.	Mfg. No.	Description
469-08288	VCT-031	Valve Core Torque Tool

VALVE CORE TORQUE TOOL

- Preset torque guarantees correct setting every time on all cores!
- Can be used to install and remove cores in standard valve stems
- Calibrated to 4 in./lb. of torque
- Meets the Tire & Rim Association (TRA) specifications for installing valve cores on TPMS applications

Ascot No.	Mfg. No.	Description
469-00044	TPMS-4VC	Valve Core Torque Tool

SCREWDRIVER/CORE TOOL

- Lock-On Feature For The Valve Core
- Metal Pocket Clip
- Flat-Head Screwdriver Tip

Ascot No.	Mfg. No.	Description
469-00673	673-D	Screwdriver/Core Tool

HEX HANDLED STEEL VALVE CORE TOOL

- For inserting and removing valve cores
- Long hex body for easy access

Ascot No.	Mfg. No.	Description
469-01115	VT-1115S	Hex Handled Steel Valve Core Tool

RECESSED VALVE CORE TOOL

- Core tool is recessed into the handle through a shirt pocket
- Design eliminates the possibility of the tool poking
- Easily fits into a shirt pocket
- Includes clip

Ascot No.	Mfg. No.	Description
469-11115	VT-11151	Recessed Valve Core Tool

HOOK AND PICK SET

- Comfortable material handle
- 4 picks: combination pick 90° pick, straight pick, and hook pick
- Help removal of o-ring, cotter pin seals, and bushes in various automotive applications
- **Made in Taiwan**

Ascot No.	Mfg. No.	Description
319-46464	AS-MHPS	Hook And Pick Set

TIRE DEFLATOR SET

- Valves deflate pressure slowly to protect TPMS sensors
- No need to remove TPMS valve core
- Cups colored and marked with tire position to prevent incorrect tire mounting

Ascot No.	Mfg. No.	Description
469-51632	TD-1808	Tire Deflator Set

VALVE HARDWARE TOOLS & ACCESSORIES

9/16" SINGLE HEX VALVE STEM RATCHET WRENCH

- For TR570 Series Valves

Ascot No.	Mfg. No.	Description
469-00018	VSW-18	9/16" Single Hex Valve Stem Ratchet Wrench

5/8" DOUBLE HEX VALVE STEM RATCHET WRENCH

- For TR540 Series Valves

Ascot No.	Mfg. No.	Description
469-00020	VSW-20	5/8" Double Hex Valve Stem Ratchet Wrench

VALVE STEM WRENCH KIT

- Kit includes 9/16" & 5/8" valve stem wrenches in durable pouch

Ascot No.	Mfg. No.	Description
469-01820	VSW-1820-KIT	Valve Stem Wrench Kit

STUBBY FLEX HEAD COMBINATION WRENCHES

- Needs as little as 5 degrees to move a fastener
- 180 degree flex action head that allows access into the tightest applications
- Short pattern along with the slim head and body allow the stubby wrenches into places where no other wrench will work
- 12 point ratchet ring
- Enhanced open end design that prevents fastener rounding
- Size stamped on wrench for ease of identification
- Ideal for use with TR540-550 & TR570 series clamp-in tire valves
- **Made in Taiwan**

Ascot No.	Mfg. No.	Description
313-00058	58SFHCW	5/8" Stubby Flex Head Combination Wrench
313-00916	916SFHCW	9/16" Stubby Flex Head Combination Wrench

FLEX HEAD OPEN END COMBINATION WRENCHES

- Flex head capable of tilting 180 degrees
- 72 teeth with double stack pawls to provide 144 tips (ratcheting positions)
- 144 tips provides wrench with more movement, 2.5-degree space requirement for each turn
- Made with chrome vanadium steel for strength to exceed international standards
- Designed for working in confined space
- Meets ANSI specification
- Professional plating to prevent corrosion
- Ratcheting head allows fastener to travel without removing the ratchet head
- Non-slip open end allows 4 contact points, conventional open end offers 2 contact points
- 12-point box end with ratcheting function
- **Made in Taiwan**
- Same factory as Milwaukee Tools
- **Similar to Milwaukee 45-96-9815 & Milwaukee 45-96-9816**

Ascot No.	Mfg. No.	Description
313-01916	3205	9/16" Flex Head Open End Combination Wrench
313-00158	3027	5/8" Flex Head Open End Combination Wrench



VALVE HARDWARE TOOLS & ACCESSORIES

VALVE AND CORE TOOLS (CONT.)

Ascot No.	Mfg. No.	Description
469-23430	23.4300	TUBE DEFLATING ASPIRATOR <ul style="list-style-type: none"> Screwing aspirator onto valve mouth and applying air chuck to threaded inlet creates vacuum that siphons air from tube
469-32855 469-32856	3285D 3285E	LOCK-ON SCREWDRIVER CORE TOOLS <ul style="list-style-type: none"> Lock-On Screwdriver Core Tools Allows the valve core to stay attached to the tool after it is removed from the valve Protects the valve core from loss <ul style="list-style-type: none"> Aluminum handles provide a sturdy a grip for inserting and removing valve cores 469-32855: 5" Effective length 469-32856: 6.5" Effective length
469-52000	S-2	VALVE CAPPER INNER DUAL VALVE CORE/CAP TOOL

STANDARD BORE VALVE TOOLS

Ascot No.	Mfg. No.	Description
469-00612	612	STANDARD BORE LONG VALVE CORE TOOL <ul style="list-style-type: none"> 8" overall length, blade length of 5-1/8" Oversized handle Made in USA <ul style="list-style-type: none"> Packaged 200 per case Equivalent to Haltec TL-612 Made in USA
469-00610	CT6-10	STANDARD BORE VALVE CORE TOOL <ul style="list-style-type: none"> Has a plastic screwdriver handle for better grip and leverage 10 Pack Made in China
469-00123	AS-123	STANDARD BORE VALVE CAP INSTALLATION/REMOVAL TOOL <ul style="list-style-type: none"> Similar to Haltec TL-633 Easy to remove and install valve caps on inside dual wheels Designed for aluminum wheels with small hand holes, it comes with a protective sleeve to prevent scratching Works great at removing tight or cross-threaded caps Positive hold while valve is serviced Keeps cap in tool Length 8.25" without handle Made in China

TRUCK AND SPECIALTY VALVES

Ascot No.	Mfg. No.	Description
469-00580	X-10NS58B	BRASS TIRE VALVE NUT SPLITTER <ul style="list-style-type: none"> Removes brass tire valves from truck rims
469-22011	VB	VALVE BLASTER TRUCK VALVE STEM REMOVAL TOOL <ul style="list-style-type: none"> Removes valves quickly Slide hammer with an internal spring absorbs the shock of impact Easy to use Designed to shear the bottom flange off the valve with one or two blows 63" overall length
469-22012	RE	REPLACEABLE END FOR VALVE BLASTER TRUCK STEM REMOVAL TOOL
469-32011	35936	KEN TOOL VALVE BREAKER TOOL



MISCELLANEOUS TIRE SERVICING TOOLS

BRAKE LINING THICKNESS GAUGE

- Made of durable metal
- Each blade features both SAE and Metric measurements
- Clear and accurate depth readings for a quick and easy reading
- Color coded brake gauge provides effective identification
- **THE SET IS DIVIDED INTO 3 COLORS:** Red, Yellow and Green
- *Red 2 mm (.787") Brakes must be serviced*
- *Yellow 4 mm (.1575") Brakes must be serviced*
- Made in Taiwan

Ascot No.	Mfg. No.	Description
411-65201	B650201	8-Piece Brake Lining Thickness Gauge



411-65201
8-Piece Brake Lining Thickness Gauge

BRAKE THICKNESS GAUGE

- Quickly and easily determine the remaining thickness of a vehicle's brake pads without removing any wheel components
- Color coded gauge determines if the brake pads need to be replaced
- On the gauge, the colors correspond with the brake pad thickness readings:
- 11mm or more - Green, no replacement necessary
- 8mm to 10mm - Yellow, suggest replacement soon
- 0mm to 8mm - Red, recommend replacement

Ascot No.	Mfg. No.	Description
411-03218	NS-3218P	Brake Thickness Gauge



411-03218
Brake Thickness Gauge

TIRE TREAD DEPTH GAUGES

Ascot No.	Mfg. No.	Description
454-00190	HT-190L	3-Color All-Metal Tread Depth Gauge
454-00599	595	Tire Tread Depth Gauge
454-00712	NS712	All-Metal Tread Depth Gauge
454-01599	599-C	3-Color Tread Depth Gauge

454-00190
3-Color All-Metal Tread Depth Gauge

454-01599
3-Color Tread Depth Gauge

454-00599
Tire Tread Depth Gauge

454-00712
All-Metal Tread Depth Gauge

DIGITAL TREAD DEPTH GAUGE

- Made from strong carbon fiber composite
- Zero setting in any position
- Metric, decimal inch and fraction inch toggle
- Large LCD display

Ascot No.	Mfg. No.	Description
454-00209	NS209S	Digital Tread Depth Gauge



454-00209
Digital Tread Depth Gauge

MISCELLANEOUS TIRE SERVICING TOOLS



454-11410
Aluminum OTR Tire
Tread Depth Gauge

COMING SOON!
FALL 2024

ALUMINUM OTR TIRE TREAD DEPTH GAUGE

- Indicating bar is calibrated in 32nds on one side and millimeters on the other
- Magnified sight glass for easily reading the measurements
- Measures tread depth up to 6"
- Made from aluminum
- Comes in a black leather pouch
- Similar to Haltec N-1410
- **Made in Taiwan**

Ascot No.	Mfg. No.	Description
454-11410	ASN-1410	Aluminum OTR Tire Tread Depth Gauge



454-06763
PCD Wheel Bolt
Measuring Tool

NEW

PCD WHEEL BOLT MEASURING TOOL

- Can be used to measure a wheel or turned over to measure studs on a vehicle
- This wheel rim bolt pattern gauge is made of the best quality plastic material
- Lightweight and durable
- Quickly measures most common 4, 5, 6, 8 lug bolt patterns, it shows both inch and metric sizes.

Ascot No.	Mfg. No.	Description
454-06763	676-3	PCD Wheel Bolt Measuring Tool



454-01420
Truck Tire Tread
Depth Gauge

TRUCK TIRE TREAD DEPTH GAUGE

- Calibrated in millimeters and 1/32nds
- Measures shoulder wear as well as tread depth
- Durable metal construction
- *Protective pouch included*

Ascot No.	Mfg. No.	Description
454-01420	HT-1420	Truck Tire Tread Depth Gauge

MISCELLANEOUS TIRE SERVICING TOOLS

WHEEL BOLT PATTERN GAUGE

Ascot No.	Mfg. No.	Description
454-03000	WG-3000	Wheel Bolt Pattern Gauge - New Style

454-03000
Wheel Bolt
Pattern Gauge,
New Style



8-PIECE LUG NUT & WHEEL STUD CHECKER SET

- Wheel stud thread size gauge includes both male and female threads for checking lug nuts, wheel locks and wheel studs
- 8 sizes to verify most common bolts and lug thread sizes
- Size permanently stamped onto each gauge
- Color coded for easy identification
- **INCLUDES:** Purple (M12x1.25), Orange (M12x1.50), Pink (M12x1.75), Black (M14x1.50), Silver (M14x2), Red (9/16x18), Green (7/16x20) & Blue (1/2x20)

Ascot No.	Mfg. No.	Description
493-00801	8TGCS	8-Piece Lug Nut & Wheel Stud Thread Checker Set

493-00801
8-Piece Thread
Checker Set



ASCOT & MARKAL B PAINTSTICKS

- Real lead-free paint in stick form
- Combines long-lasting durability of paint with an ease-of-use crayon
- **TEMPERATURE RANGE:** -50 to 150 degrees F
- For use on metal, wood, plastic, concrete, rubber, glass, cardboard & paper
- Marks on smooth, rough, rusty or dirty surfaces and also marks through oil & water

Ascot No.	Mfg. No.	Description	Qty./Case
459-80220	80220	Markal B White Paintstick	144
459-80221	80221	Markal B Yellow Paintstick	144
459-80257	80257	Ascot B White Paintstick	144
459-80258	80258	Ascot B Yellow Paintstick	144
459-80271	80271	Ascot B Orange Paintstick	144

Ascot B
Paintsticks



Markal B
Paintsticks

EZ BREAK ANTI-SEIZE

- Copper-based anti-seize and lubricating compound
- Resists rust and corrosion
- Authorized by USDA for use in federally inspected meat and poultry plants
- Working temperature to 1800 degrees F
- Recommended for nuts, bolts, valves, flanges & splines for easy break out after years of service

Ascot No.	Mfg. No.	Description	Qty./Case
494-01010	008910	EZ Break Anti-Seize: 10 oz. Can w/ Brush-In Cap	24
494-08916	008916	EZ Break Anti-Seize: 14 oz. Aerosol Can	12

494-08916
EZ Break
Anti-Seize,
14 oz.
Aerosol
Can

494-01010
EZ Break
Anti-Seize,
10 oz. Can
with Brush-
In Cap



GAUGE ACCURACY GUIDE

Why do you need Quality Air Gauges?

Keeping an eye on tire pressure is a critical part of regular inspection and maintenance. Tire pressure is a critical function in many different ways. Underinflated (or grossly overinflated) tires don't handle safely, and if you find yourself in a "steer out of trouble" situation, improperly inflated tires can get you into a lot of trouble. Low tires heat up and can blow out, not only destroying the tire but also putting you in an accident-likely situation. Keeping tires properly inflated also makes sense from a dollars and sense perspective: Underinflated tires wear out more quickly. Overinflated tires can make the ride rough, and actually wear out suspension parts. And yes, fuel economy is really affected by tire inflation. The solution to these safety and money issues is as simple as regularly checking tire inflation, and for this you need an accurate tire pressure gauge. PLEASE USE THIS GAUGE ACCURACY GUIDE AS A HELPFUL TOOL!

GOOD	BETTER	BEST
3% ACCURACY	1-2% ACCURACY	.5% ACCURACY

A QUICK GUIDELINE FOR OUR GAUGES IS SHOWN WITH THE PRODUCTS IN THE SECTIONS BELOW

1-2% ACCURACY

ANALOG GAUGES

RECOMMENDED FOR ALL TYPES OF VEHICLES



477-10004
0-138 PSI

GOOD	BETTER	BEST
3% ACCURACY	1-2% ACCURACY	.5% ACCURACY

.5% ACCURACY

DIGITAL GAUGES

RECOMMENDED FOR ALL TYPES OF VEHICLES



477-10312
1-174 PSI



477-11237
0-174 PSI

GOOD	BETTER	BEST
3% ACCURACY	1-2% ACCURACY	.5% ACCURACY

0.5% ACCURACY

DIGITAL & PENCIL GAUGES

RECOMMENDED FOR ALL TYPES OF VEHICLES



476-03501
10-100 PSI

477-10001
0-174 PSI

477-11612
1-174 PSI

GOOD	BETTER	BEST
3% ACCURACY	1-2% ACCURACY	.5% ACCURACY

1-2% ACCURACY

PENCIL GAUGES

RECOMMENDED FOR ALL TYPES OF VEHICLE



476-10160
20-120 PSI

476-10105
10-50 PSI

GOOD	BETTER	BEST
3% ACCURACY	1-2% ACCURACY	.5% ACCURACY

1-2% ACCURACY

TRUCK SERVICE GAUGES

RECOMMENDED FOR ALL TYPES OF VEHICLES



476-10155
10-150 PSI

476-10480
10-150 PSI

GOOD	BETTER	BEST
3% ACCURACY	1-2% ACCURACY	.5% ACCURACY

1-2% ACCURACY

BAYONET & SIGHT GLASS GAUGES

RECOMMENDED FOR ALL TYPES OF VEHICLES ASSEMBLED IN THE USA



477-00001
0-150 PSI

GOOD	BETTER	BEST
3% ACCURACY	1-2% ACCURACY	.5% ACCURACY

AIR PRESSURE GAUGES, INFLATOR GAUGES

476-00211
Gauge Counter Display

GAUGE COUNTER DISPLAYS

- Low pressure for general use
- High pressure for SUVs, trucks and other high pressure applications
- Gauges calibrated in 2 lb. increments
- Aluminum barrel

Ascot No.	Mfg. No.	Description
476-00211	211-DIS	Counter Display of 10 Low Pressure Gauges (10-50 PSI)
476-00941	941-DIS	Counter Display of 10 High Pressure Gauges (10-120 PSI)



SCREWDRIVER ADJUSTABLE CALIBRATION GAUGE

- External Adjustment Screw makes calibration quick & easy
- Plated finish provides corrosion protection and great looks
- 4-sided metal indicator bar is durable and easy to read
- Hang-up ring provides a convenient method of storage
- Flat-head screwdriver required for calibration

Ascot No.	Mfg. No.	Description
476-01046	1046-ADJ	Screwdriver Adjustable Calibration Gauge



EXTERNAL ADJUSTABLE CALIBRATION GAUGES

- External adjustment screw makes calibration quick and easy
- 2-sided metal bar is durable and easy to read
- Heavy duty plated finish provides corrosion protection*
- Flathead screwdriver required for calibration



Chrome recalibration screw on all of the chrome plated gauges

Black recalibration screw on the gauge with the epoxy finish (476-00165)

Ascot No.	Mfg. No.	Description
476-00165	HT-165S-RCL	<ul style="list-style-type: none"> • Hang-up ring provides a convenient method of storage • Calibrated 10-150 PSI • Straight-on/30° reverse angled chuck • Equivalent to Haltec GA-165S-RCL
476-00255	HT-155S-RCL	<ul style="list-style-type: none"> • Chuck swivels for ease of use in tight areas • Calibrated 10-150 PSI • Equivalent to Haltec GA-255S-RCL

*Part # 476-00165 has black epoxy finish.

AIR PRESSURE GAUGES, INFLATOR GAUGES



AUTO
POWER OFF

476-03238
Digital Truck Tire Gauge

DIGITAL TRUCK TIRE GAUGE

- **OPERATING RANGE:** 0-180 PSI
- **RESOLUTION:** 0.5 PSI
- **ACCURACY:** ± 1% + 0.5 PSI at 100 PSI
- Calibration in BAR, KG/CM², KPA and PSI
- Auto Power Off - Simple Operation
- Built-in Backlight with Clear, Large LCD Display
- Replaceable LED Battery
- **POWER SOURCE:** Lithium & LR 44 Alkaline

Ascot No.	Mfg. No.	Description
476-03238	3238P-2	Digital Truck Tire Gauge



476-10500
Digital Passenger Gauge

DIGITAL PASSENGER GAUGE

- Large, easy-to-read LCD numbers for precise readings
- Features pinpoint accuracy, convenient air bleed, protective casing
- Features dual foot chuck

Ascot No.	Mfg. No.	Description
476-10500	DT-105	Digital Passenger Gauge: 1-100 PSI



476-32380
Digital Pocket Gauge

DIGITAL POCKET GAUGE

- Range: 0-150 PSI in .5 PSI increments
- **ACCURACY:** ±1 PSI
- Large LCD display
- Red backlight
- Angled chuck head

Ascot No.	Mfg. No.	Description
476-32380	3238P	Digital Pocket Gauge w/ Angle Chuck: 1-150 PSI

AIR PRESSURE GAUGES, INFLATOR GAUGES

ADJUSTABLE FIELD SERVICE GAUGE

- Field adjustable truck service gauge
- Adjustable calibration
- Chrome finish

Ascot No.	Mfg. No.	Description
476-07285	7285-R	Adjustable Field Service Gauge

476-07285
Adjustable Field Service Gauge

AUTOMOTIVE TIRE GAUGES

- Pencil, chrome tire gauges with nylon indicator bars

Ascot No.	Mfg. No.	Description
476-10100	945	Extra-Low Pressure Tire Gauge (1-20 lb.): Chrome-Plated
476-10105	910	10-50 psi Passenger Tire Gauge: Chrome-Plated
476-10115	920	High Pressure Pencil Gauge (20-120 lb.)
476-10125	120	Air/Liquid Tire Gauge (5-45 lb.): Chrome-Plated, Nylon Bar
476-10145	975	Mid-Range Pencil Gauge (10-75 lb.): Chrome-Plated, Calibrated in lb./kPa

476-10125
Automotive Tire Gauge

POCKET TRUCK GAUGES

Ascot No.	Mfg. No.	Description
476-10130	1314	Dual Foot - High Pressure Pencil Gauge (20-120 lb.)
476-10150	1317	Dual Straight Pencil Gauge (20-120 lb.) Chrome Plated
476-10160	1317T	Dual Chuck Service Gauge: Black Epoxy Straight-On/Angled (4-Sided Nylon Bar)

476-10160
Pocket Truck Gauge

DUAL FOOT CHUCK

- Used to check accuracy of gauges
- Calibrated 10-160 PSI

Ascot No.	Mfg. No.	Description
476-10140	1075	Dual Foot Chuck

476-10140
Dual Foot Chuck

PROFESSIONAL SIGHT GLASS MASTER TRUCK GAUGE

- Range: 10-160 PSI in 2 PSI increments
- **ACCURACY:** ± 1 PSI
- Highest quality, best design
- 360-degree swivel head

Ascot No.	Mfg. No.	Description
476-32922	3292E-RED	Sight Glass Master Truck Gauge: Angle Chuck

476-32922

AIR PRESSURE GAUGES, INFLATOR GAUGES

TRUCK SERVICE GAUGES

- Wide variety of service gauges to accommodate the numerous tire and wheel configurations encountered by tire service personnel
- Available in chrome-plated or protective black epoxy finish as indicated
- Calibrated from 10-150 psi in 2 pound increments
- Nylon or metal indicator bars

Ascot No.	Mfg. No.	Description
476-10135	1031	Dual Foot Service Gauge (10-150 lb.): Chrome-Plated, Nylon Bar
476-11135	1038	Dual Foot Service Gauge (10-150 lb.) w/ Heavy Duty Metal Bar
476-10155	1045	Dual Straight Service Chuck Gauge (10-150 lb.): Chrome-Plated
476-10165	1045T	Dual Chuck Service Gauge: Black Epoxy, Straight-On/ Angled, 4-Sided Nylon Bar
476-11165	HT-165	Dual Chuck Service Gauge: Black, 2-Sided Bar
476-11155	1048	Dual Straight Service Chuck Gauge (10-150 lb.): Chrome-Plated w/ Metal Bar
476-10185	1095	Dual Foot Service Gauge w/ Nylon Bar (180° Foot Chuck)
476-11185	1096	Dual Foot Service Gauge w/ Metal Bar (180° Foot Chuck): Chrome
476-10480	1048T	Dual Chuck Service Gauge: Black Epoxy, Straight-On/Angled, Metal Bar
476-11148	1048S	Dual Straight Service Gauge: Short Length

LARGE BORE GAUGES

- Swivel gauge swivels 360 degrees for those hard to reach valves

Ascot No.	Mfg. No.	Description
476-10240	1086	Large Bore Straight Gauge: 20-120 PSI
476-10255	1085	Large Bore Swivel Gauge: 10-150 PSI

LARGE BORE HIGH PRESSURE AIR GAUGE

- 10-150 psi in 3 lb. increments
- For standard & large bore valves
- Nylon indicating bar
- Chrome finish
- Similar to Haltec GA-250
- **Made in China**

Ascot No.	Mfg. No.	Description
476-11250	AS-250	Large Bore High Pressure Air Gauge

DIGITAL TRUCK GAUGE

- Large, easy-to-read LCD numbers for precise readings
- Features pinpoint accuracy, convenient air bleed, protective casing
- Features dual foot chuck
- **Made In Taiwan**

Ascot No.	Mfg. No.	Description
476-15038	DT150-38CV	Digital Truck Gauge: 3-160 PSI

476-10240
Large Bore
Straight Gauge

476-10255
Large Bore
Swivel Gauge

476-11250
Large Bore High
Pressure Air Gauge

NEW

476-15038
Digital Truck
Gauge

AIR PRESSURE GAUGES, INFLATOR GAUGES

MASTER AIR GAUGE CHECKING STATIONS

- **INFLATION RANGE:** 0-200 PSI
 - **ACCURATE TO:** ±1 PSI
 - Designed to allow users to quickly and accurately check their air gauges and inflator gauges
 - **THREE CHECKING POINTS:** standard valve port, large bore valve port & female coupler port
 - **MOST ACCURATE CHECKING**
- STATION ON THE MARKET**
- Equipped with a regulator and filter for proper air and water filtration
 - CARB Certified
 - Back-lit readout for ease of use
 - Can be mounted to a bench or a wall
 - **Made In Taiwan**

Ascot No.	Mfg. No.	Description
476-35020	TS3502A	Digital Gauge Checking Station
476-35021	TS3502AL	Air/Liquid Gauge Checking Station



476-35020
Digital Gauge Checking Station

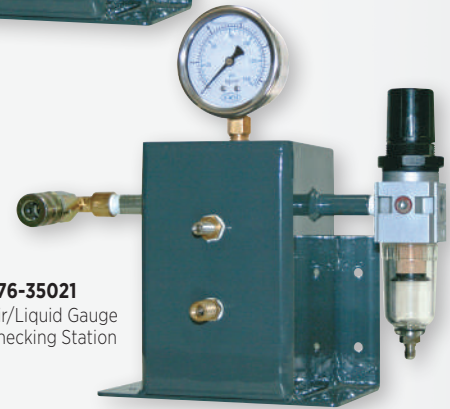

476-35021
Air/Liquid Gauge Checking Station

DIGITAL TIRE INFLATORS

- **INFLATION RANGE:** 0-174 PSI
 - **ACCURATE TO:** ± 1.2 psi
 - Auto ON, upon air pressure sensing
 - Large tilted LCD display with backlight and 90 second auto OFF
 - Multi-scale gauge
- Die-cast aluminum unit with rubber protective sleeve
 - Lightweight handle and trigger
 - Wire sheathed hose on flex area of hose to eliminate kinking
 - .5% Accuracy
 - *Brand may vary*



Ascot No.	Mfg. No.	Description
477-11235	11.0723ASC5	Digital Inflator: 20" Hose w/ Clip-On Chuck
477-11237	11.0723ASC7	Digital Inflator: 6' Hose w/ Clip-On Chuck
477-11239	—	Replacement 6' Hose w/ Clip-On Chuck for Digital Inflators
477-11240	—	Replacement 20" Hose w/ Clip-On Chuck for Digital Inflators



477-11235
RPG Digital Inflator: 20' Hose w/ Clip-On Chuck



OSHA Regulations require that an inflator gauge must be equipped with a lock-on chuck and have a hose extension sufficiently long for the operator to stand clear of the possible trajectory of a multi-piece rim.

* This gauge provides more accurate air pressure readings which is essential with TPMS.

AIR PRESSURE GAUGES, INFLATOR GAUGES



477-10312
Digital Inflator
w/ 20" Hose
and Hold-on
Air Chuck



477-11612
Automatic Inflator -
5' Hose w/ Clip-
On Air Chuck

DIGITAL INFLATOR

- Auto on/off operation
- **MAX INFLATION:** 174 PSI
- Accuracy exceeds EC Standards
- Multi-scale gauge
- Serial/batch numbered
- Backlit digital display
- Wire sheathed hose eliminates kinking
- Impact absorbing bumpers
- Rubber grip on chuck
- Tough die cast aluminium body
- 20" hose with hold-on chuck
- Quick and easy to use
- *Includes certificate of calibration*
- **.5% Accuracy**

MULTI-SCALE GAUGE:

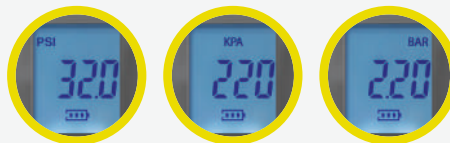

Ascot No.	Mfg. No.	Description
477-10312	10.3012NA	Digital Inflator w/ 20" Hose and Hold-On Air Chuck

AUTOMATIC INFLATOR

- All the features of a wall mounted inflator in a portable hand held unit
- **BUILT-IN OVERPRESSURE SETTING FUNCTION:** OPS function that allows the tire to be inflated to a certain pressure then deflates automatically to a normal operating pressure, used to seat tires to rims
- Auto on/off operation
- **MAX INFLATION:** 174 PSI
- Accuracy exceeds EC Standards
- Multi-scale gauge
- Serial/batch numbered
- Backlit digital display
- Wire sheathed hose eliminates kinking
- Tough poly carbonate/ABS body
- Two programmable pre-set preset buttons
- Fast and safe
- 5' hose with lock-on chuck
- Built-in rechargeable lithium-ion battery
- Up to 15 hours of continuous use
- *Includes AC adapter for charging*
- *Includes certificate of calibration*
- **.5% Accuracy**

Ascot No.	Mfg. No.	Description
477-11612	11.0612NA	Automatic Inflator - 5' Hose w/ Clip-On Air Chuck

ASCOT REBRAND COMING SOON!



OSHA Regulations require that an inflator gauge must be equipped with a lock-on chuck and have a hose extension sufficiently long for the operator to stand clear of the possible trajectory of a multi-piece rim.

AIR PRESSURE GAUGES, INFLATOR GAUGES

MK4 HEAVY DUTY HAND-HELD INFLATOR

- **NEW VIEWING WINDOW:** Larger window gives 20% greater field of viewing
- **LIGHTER WEIGHT:** Gauge body weighs 2.035 lb., less work strain and easier for repetitive use
- **BIOMORPHIC SHAPE:** Ergonomic, easier to use and less prone to damage when dropped
- **NEW CLEAR LITHOGRAPHIC DESIGN:** Fast and accurate reading of results
- **NEW VALVE MECHANISM:** Simplified 2-stage mechanism design prevents user having to “push” against full line pressure on deflate preventing fatigue
- **NEW PISTON & SEAL DESIGN:** New design, less drag, reduced friction & less movement inertia means no internal corrosion, no sticking and no skewing of accuracy
- **MAXIMUM INFLATION PRESSURE:** 160 PSI
- **1-2% Accuracy**



477-10004
MK4 Heavy Duty Hand-Held Inflator

NEW PISTON & SEAL DESIGN

Ascot No.	Mfg. No.	Description
477-10004	MK4	MK4 Heavy Duty Hand-Held Inflator

DIGITAL HAND-HELD TIRE INFLATOR

- **INFLATION RANGE:** 0-174 PSI
- **ACCURACY:** ± .2 PSI
- 6' Hose
- Lightweight shock resistant design
- High specification ceramic sensor
- Long life, easily replaceable battery
- Available in custom hose lengths and chuck styles
- **1-2% Accuracy**



477-10001
Digital Hand-Held Tire Inflator

LIGHTWEIGHT & SHOCK RESISTANT

Ascot No.	Mfg. No.	Description
477-10001	Accura 1	Hand-Held Digital Tire Inflator: 6' Hose

DIGITAL INFLATOR GAUGE

- Large, clear, easy to read LCD display with backlight
- **RELIABLE ACCURACY:** ± 1 psi up to 60 psi, then 2 psi up to 150 psi (with individual testing and certification)
- Easy and cost effective to use
- Low and simple maintenance
- Suitable for all applications including tire shop environments
- Powered by PCL inflation technology and experience
- 6' hose w/ clip-on chuck
- **1-2% Accuracy**



477-10008
Digital Inflator Gauge

Ascot No.	Mfg. No.	Description
477-10008	DT108	Digital Inflator Gauge



OSHA Regulations require that an inflator gauge must be equipped with a lock-on chuck and have a hose extension sufficiently long for the operator to stand clear of the possible trajectory of a multi-piece rim.

AIR PRESSURE GAUGES, INFLATOR GAUGES



477-11623
4-Way Inflator Kit

4-WAY INFLATOR KIT

- Quick coupler connects directly to the inflator
- Slide valve allows air supply to be turned on/off
- Includes all hoses and connection

• **USA hoses**

Ascot No.	Mfg. No.	Description
477-11623	11.0623NA	4-Way Inflator Kit - 25ft Hoses
477-11625	11.0625NA	4-Way Inflator Kit - 10ft Hoses

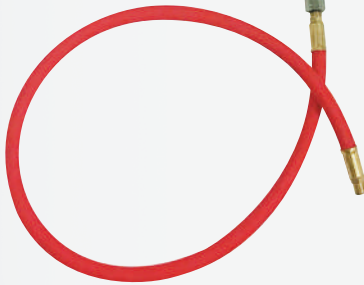

477-11624
4-Way Accessory Block

4-WAY ACCESSORY BLOCK

- Lightweight aluminum manifold splits air lines into 4 separate lines
- Slide valve turns air on/off to start inflation
- **(4) 1/4" universal quick couplers allow for any type fitting**
- 3' whip hose
- **USA hoses**
- **Made in Taiwan**

Ascot No.	Mfg. No.	Description
477-11624	N/A	4-Way Accessory Block

477-47732
6-in-1 Air Line Manifold Kit



6-IN-1 AIR LINE MANIFOLD KIT

- Lightweight aluminum manifold
- 1/4" air inlet
- (6) 1/4" outlets
- (3) 1/4" aluminum plugs
- **Made in Taiwan**

Ascot No.	Mfg. No.	Description
477-47732	N/A	6-in-1 Air Line Manifold Kit



OSHA Regulations require that an inflator gauge must be equipped with a lock-on chuck and have a hose extension sufficiently long for the operator to stand clear of the possible trajectory of a multi-piece rim.

AIR PRESSURE GAUGES, INFLATOR GAUGES

AIR LINE INFLATORS

Ascot No.	Description
AIR LINE INFLATOR GAUGES	
477-00001	12" Hose w/ Dual Foot Chuck
477-00011	12" Hose w/ Tapered Chuck
477-00111	12" Hose w/ Lock-On Chuck
477-01111	12" Hose w/ No Chuck
477-11111	12" Hose w/ Lock-On Chuck & Bleeder Valve
SAFETY INFLATOR GAUGES	
477-00002	3' Hose w/ Ball Foot (Clip-On) Chuck
477-00003	3' Hose w/ Straight Lock-On Chuck
477-00004	6' Hose w/ Ball Foot (Clip-On) Chuck
477-00005	6' Hose w/ Straight Lock-On Chuck
477-00006	6' Hose Assembly
477-00007	3' Hose Assembly
477-00008	9' Hose w/ Ball Foot (Clip-On) Chuck
477-00009	9' Hose w/ Straight Lock-On Chuck
477-00010	12' Hose w/ Ball Foot (Clip-On) Chuck
477-00012	12' Hose w/ Straight Lock-On Chuck
477-00014	6' Hose w/ No Chuck
477-00015	15' Hose w/ Straight Lock-On Chuck
477-00020	20' Hose w/ Straight Lock-On Chuck
477-00033	3' Hose w/ Euro-Style Chuck
477-00066	6' Hose w/ Euro-Style Chuck
477-00099	9' Hose w/ Euro-Style Chuck
477-00112	3' Hose w/ No Chuck
477-00113	3' Hose w/ Sleeve Chuck
477-00115	6' Hose w/ Black Epoxy Lock-On Chuck
477-00116	6' Hose w/ European Air Chuck
477-00117	3' Hose w/ European Air Chuck
477-00118	9' Hose w/ No Chuck
477-00144	12' Hose w/ Euro-Style Chuck
477-01112	12' Hose w/ No Chuck

Safety Inflator Gauge with Ball Foot (Clip-On) Chuck

Safety Inflator Gauge with Straight Lock-On Chuck



Air Line Inflator Gauge

LARGE BORE AIR LINE INFLATOR GAUGES

- Large Bore inflation unit with in-line gauge
- Equipped with AC-B12 large bore chuck
- Gauge is calibrated 10-140 PSI in 2 lb. increments
- Available in hose lengths of 6', 9', 12' & 24'
- USA hoses

Ascot No.	Description
477-01006	6' Hose with AC-B12 Large Bore Chuck
477-01009	9' Hose with AC-B12 Large Bore Chuck
477-01012	12' Hose with AC-B12 Large Bore Chuck
477-01025	25' Hose with AC-B12 Large Bore Chuck

Air Line Inflator Gauge



OSHA Regulations require that an inflator gauge must be equipped with a lock-on chuck and have a hose extension sufficiently long for the operator to stand clear of the possible trajectory of a multi-piece rim.

AIR CHUCKS & ACCESSORIES



478-00305



478-05451



478-02985



478-00001



478-00340
Lock-On
Air Chuck



BALL FOOT CHUCKS

Ascot No.	Mfg. No.	Description
478-00305	5565	Ball Foot Air Chuck: 1/4" FPT Fitting (Normally Closed)
478-00315	5567	Ball Foot Air Chuck & Clip: 1/4" FPT (Normally Closed)
478-00325	5567-FT	Ball Foot Air Chuck & Clip: 1/4" FPT (Normally Open)
478-05451	N/A	Heavy Duty Clip-On Ball Foot Air Chuck: Alligator (Normally Closed)

EUROPEAN STYLE CLIP-ON CHUCKS

- These chucks feature the popular European-style clip-on design

Ascot No.	Mfg. No.	Description
478-02985	5570	Clip-On Air Chuck: European Style (Closed)
478-02995	5570-FT	Clip-On Air Chuck: European Style (Open)
478-00001	AC-1	Euro-Style Air Chuck: 1/4" Hose Barb (Open)

LOCK-ON AIR CHUCK

Ascot No.	Mfg. No.	Description
478-00340	5560	Lock-On Chuck: 1/4" FPT Fitting (Normally Closed)

DUAL FOOT AIR CHUCKS

Ascot No.	Mfg. No.	Description
478-00335	6566	Dual Foot Chuck: 1/4" FPT, Plated Finish (Normally Closed)
478-01330	6568-FT	Dual Foot Chuck: 1/4" FPT, 6" Long, Lock-On Threads (Normally Open)
478-01335	6566-FT	Dual Foot Chuck: 1/4" FPT, Plated Finish (Normally Open)
478-01350	6568T	Dual Foot Black Epoxy Straight-On/Angled (Normally Closed)
478-01352	6568TL	Dual Foot Black Chuck: 14" (Normally Closed)
478-03300	6568	Dual Foot Chuck: 1/4" FPT, 6" Long, Lock-On Threads
478-03301	6569	Dual Foot Chuck w/ Straight-On Chuck: 1/4" FPT
478-03330	6568L	Straight-on/Angle Normally Closed Chuck w/ Lock-On Feature: 14" Length
478-03370	6596	180° Dual Foot Air Chuck w/ Lock-On Feature

AIR CHUCKS & ACCESSORIES



LARGE BORE AIR CHUCKS

Ascot No.	Mfg. No.	Description
478-00377	AC-B11	Long Lock-On Large Bore Air Chuck
478-00328	AC-B10	Short Lock-On Large Bore Air Chuck
478-04660	AC-B12	Large Bore Clip-On Air Chuck
478-06585	6585-LB	Large Bore Dual Foot Air Chuck - Right Angle
478-00322	6587-LB	Large Bore Dual Foot Air Chuck



TRUCK LOCK-ON EXTENSION CHUCK

- Extended reach for dual wheels
- Easy on/off application
- Steel pins for increased service life
- Automatic locking design
- Improves seal on flow through caps
- 22" overall length
- **Made in Taiwan**



Ascot No.	Mfg. No.	Description
478-32072	32071-L2	Truck Lock-On Extension Chuck

plasteel®

HYBRID-LOCK™
PLASTIC + STEEL BODY

HARDENED
STEEL CLIP

CURVED
APPEARANCE

ALUMI-FLAKE™
METALLIC MATERIAL

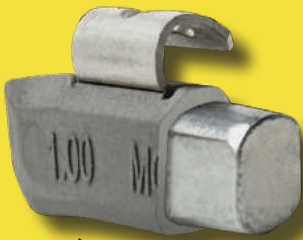

PLASTIC
FOR SOFTNESS

STEEL
FOR STRENGTH



RECYCLABLE
MATERIALS



EASY
APPLICATION



SCRATCHLESS
INSTALLATION



TECHNICIAN
APPROVED

AVAILABLE IN: **MC** **FN** **AW** **IAW** **EN** **T** **P**



TESTED.
PROVEN.
TRUSTED.

PROUDLY AVAILABLE FROM: **ASCOT**
Supply Corporation

LEAD, ZINC & STEEL WHEEL WEIGHTS

"FN" SERIES COATED LEAD WHEEL WEIGHTS

• **"FN" SERIES:** Designed for the thicker flange alloy wheels now being used on many Japanese vehicles



488-23030



NOTE: FNS = FN = ALCFN

Ascot No.	Mfg. No.	Weight	Ascot No.	Mfg. No.	Weight
"FN" SERIES: LEAD			"FN" SERIES: LEAD		
488-23010	FN010	10.0 G	488-23035	FN035	35.0 G
488-23015	FN015	15.0 G	488-23040	FN040	40.0 G
488-23020	FN020	20.0 G	488-23045	FN045	45.0 G
488-23025	FN025	25.0 G	488-23050	FN050	50.0 G
488-23030	FN030	30.0 G	488-23055	FN055	55.0 G
			488-23060	FN060	60.0 G

QUANTITY: 25 per box

"MC" SERIES COATED LEAD WHEEL WEIGHTS

• **"MC" SERIES:** "MC" is an economical alternative to OEM quality coated weights • Coated weights should be used on all vehicles having alloy wheels



488-19100



NOTE: MCS = MCN = ALCMC

Ascot No.	Mfg. No.	Weight	Ascot No.	Mfg. No.	Weight
"MC" SERIES: LEAD			"MCN" SERIES: LEAD		
488-19025	MC025N	0.25 oz.	488-19175	MC175N	1.75 oz.
488-19050	MC050N	0.50 oz.	488-19200	MC200N	2.00 oz.
488-19075	MC075N	0.75 oz.	488-19225	MC225N	2.25 oz.
488-19100	MC100N	1.00 oz.	488-19250	MC250N	2.50 oz.
488-19125	MC125N	1.25 oz.	488-19275	MC275N	2.75 oz.
488-19150	MC150N	1.50 oz.	488-19300	MC300N	3.00 oz.

QUANTITY: 25 per box



APPLICATIONS (FN SERIES):

TOYOTA: All since 1990; **LEXUS:** All since 1990; **HONDA:** All since 1989; **ACURA:** All since 1990; **NISSAN:** All since 1990; **INFINITI:** All since 1990; **ISUZU:** All since 1997; **MAZDA:** All since 1990; **DAEWOO:** All since 1999

"FN" SERIES STEEL WHEEL WEIGHTS



PERFECT

PLOMBCO PLASTEEL

APPLICATIONS (FN SERIES):

TOYOTA: All since 1990; **LEXUS:** All since 1990; **HONDA:** All since 1989; **ACURA:** All since 1990; **NISSAN:** All since 1990; **INFINITI:** All since 1990; **ISUZU:** All since 1997; **MAZDA:** All since 1990; **DAEWOO:** All since 1999

Ascot No. (For Perfect FN Series)	Perfect FN Series No.	Ascot No. (For Plombco Plasteel FN Series)	Plombco Plasteel FN Series No.	Weight
"FN" SERIES: STEEL				
488-33010	FN010FE	488-53010	FNPS-10	10 G
488-33015	FN015FE	488-53015	FNPS-15	15 G
488-33020	FN020FE	488-53020	FNPS-20	20 G
488-33025	FN025FE	488-53025	FNPS-25	25 G
488-33030	FN030FE	488-53030	FNPS-30	30 G
488-33035	FN035FE	488-53035	FNPS-35	35 G
488-33040	FN040FE	488-53040	FNPS-40	40 G

QUANTITY: 25 per box

"MC" SERIES STEEL WHEEL WEIGHTS



PERFECT

PLOMBCO PLASTEEL

APPLICATIONS (MC SERIES):

FORD: All from 1985; **CHRYSLER:** All from 1990 to 1997; some models changed to LHS in 1998; **GM:** Increasingly used starting in 1988; as of 2000 only C5 Corvette remains AWS

Ascot No. (For Perfect MC Series)	Perfect MC Series No.	Ascot No. (For Plombco Plasteel MC Series)	Plombco Plasteel MC Series No.	Weight
"MC" SERIES: STEEL				
488-29025	MC025FE	488-56025	MCPS-0.25	0.25 oz.
488-29050	MC050FE	488-56050	MCPS-0.50	0.50 oz.
488-29075	MC075FE	488-56075	MCPS-0.75	0.75 oz.
488-29100	MC100FE	488-56100	MCPS-1.00	1.00 oz.
488-29125	MC125FE	488-56125	MCPS-1.25	1.25 oz.
488-29150	MC150FE	488-56150	MCPS-1.50	1.50 oz.
488-29175	MC175FE	488-56175	MCPS-1.75	1.75 oz.
488-29200	MC200FE	488-56200	MCPS-2.00	2.00 oz.
488-29225	MC225FE	488-56225	MCPS-2.25	2.25 oz.
488-29250	MC250FE	488-56250	MCPS-2.50	2.50 oz.
-	-	488-56275	MCPS-2.75	2.75 oz.
-	-	488-56300	MCPS-3.00	3.00 oz.

QUANTITY: 25 per box

LEAD, ZINC & STEEL WHEEL WEIGHTS

"P SERIES" STEEL WHEEL WEIGHTS



PERFECT
QUANTITY: 25 per box

PLOMBCO PLASTEEL

Ascot No. (For Perfect P Series)	Perfect P Series No.	Ascot No. (For Plombco Plasteel P Series)	Plombco Plasteel P Series No.	Weight
"P" SERIES: STEEL				
488-13025	P025FE	488-55025	PPS-0.25	0.25 oz.
488-13050	P050FE	488-55050	PPS-0.50	0.50 oz.
488-13075	P075FE	488-55075	PPS-0.75	0.75 oz.
488-13100	P100FE	488-55100	PPS-1.00	1.00 oz.
488-13125	P125FE	488-55125	PPS-1.25	1.25 oz.
488-13150	P150FE	488-55150	PPS-1.50	1.50 oz.
488-13175	P175FE	488-55175	PPS-1.75	1.75 oz.
488-13200	P200FE	488-55200	PPS-2.00	2.0 oz.
488-13225	P225FE	-	-	-
488-13250	P250FE	-	-	-

APPLICATIONS (P SERIES):

STANDARD PASSENGER CAR with 13" to 15" steel wheels

"P" SERIES UNCOATED LEAD WHEEL WEIGHTS FOR PASSENGER CAR STEEL WHEELS



• **"P" SERIES:** For use on all passenger car rims with 13"-15" steel wheels • "P" series replaces the two piece (steel wheel) design commonly found on vehicles manufactured in Europe • Designed with "dovetail" clip to insure double retention of the clip to the wheel • Clips are plated and batch salt spray tested to assure compliance to demanding OEM specifications • **USE RIM GAUGE NUMBER RGPI TO VERIFY CORRECT APPLICATION** • Available in coated & uncoated

APPLICATIONS (P SERIES):

STANDARD PASSENGER CAR with 13" to 15" steel wheels



487-12100

Ascot No.	Mfg. No.	Weight
"P" SERIES: LEAD		
487-12025	P025	0.25 oz.
487-12050	P050	0.50 oz.
487-12075	P075	0.75 oz.
487-12100	P100	1.00 oz.
487-12125	P125	1.25 oz.
487-12150	P150	1.50 oz.

Ascot No.	Mfg. No.	Weight
"P" SERIES: LEAD		
487-12175	P175	1.75 oz.
487-12200	P200	2.00 oz.
487-12225	P225	2.25 oz.
487-12250	P250	2.50 oz.
487-12275	P275	2.75 oz.
487-12300	P300	3.00 oz.

QUANTITY: 25 per box

MC SERIES UNCOATED LEAD CLIP-ON WHEEL WEIGHTS



Ascot No.	Mfg. No.	Weight	Ascot No.	Mfg. No.	Weight
"MC" SERIES: LEAD			"MC" SERIES: LEAD		
487-28025	MC025	0.25 oz.	487-28175	MC175	1.75 oz.
487-28050	MC050	0.50 oz.	487-28200	MC200	2.00 oz.
487-28075	MC075	0.75 oz.	487-28225	MC225	2.25 oz.
487-28100	MC100	1.00 oz.	487-28250	MC250	2.50 oz.
487-28125	MC125	1.25 oz.	487-28275	MC275	2.75 oz.
487-28150	MC150	1.5 oz.	487-28300	MC300	3.00 oz.

QUANTITY: 50 per box

P SERIES UNCOATED LEAD CLIP-ON WHEEL WEIGHTS



Ascot No.	Mfg. No.	Weight	Ascot No.	Mfg. No.	Weight
"P" SERIES: LEAD			"P" SERIES: LEAD		
487-35025	P025	0.25 oz.	487-35175	P175	1.75 oz.
487-35050	P050	0.50 oz.	487-35200	P200	2.00 oz.
487-35075	P075	0.75 oz.	487-35225	P225	2.25 oz.
487-35100	P100	1.00 oz.	487-35250	P250	2.50 oz.
487-35125	P125	1.25 oz.	487-35275	P275	2.75 oz.
487-35150	P150	1.50 oz.	487-35300	P300	3.00 oz.

QUANTITY: 50 per box

QUANTITY: 25 per box

T SERIES COATED LEAD CLIP-ON WHEEL WEIGHTS



Ascot No.	Mfg. No.	Weight	Ascot No.	Mfg. No.	Weight
"T" SERIES: LEAD			"T" SERIES: LEAD		
489-18025	Tc025	0.25 oz.	489-18175	Tc175	1.75 oz.
489-18050	Tc050	0.50 oz.	489-18200	Tc200	2.00 oz.
489-18075	Tc075	0.75 oz.	489-18225	Tc225	2.25 oz.
489-18100	Tc100	1.00 oz.	489-18250	Tc250	2.50 oz.
489-18125	Tc125	1.25 oz.	489-18275	Tc275	2.75 oz.
489-18150	Tc150	1.5 oz.	489-18300	Tc300	3.00 oz.

QUANTITY: 25 per box

LEAD, ZINC & STEEL WHEEL WEIGHTS



486-05323



486-09462

STEEL, LEAD & ZINC WHEEL WEIGHT SAMPLE KITS

- FREE to Ascot Members
- Sampling of wheel weights in a display kit to allow salesmen
- to show customers the actual product that is available
- Steel display is made in China
- Lead & zinc displays are made in Thailand



486-00234

Ascot No.	Mfg. No.	Description
486-05323	LWWDB	Lead Clip-On Wheel Weight Display Kit
486-09462	ZWWDB	Zinc Clip-On Wheel Weight Display Kit
486-00234	SAWWDB	Steel Adhesive Wheel Weight Display Kit

FN SERIES COATED LEAD CLIP-ON WHEEL WEIGHTS



Ascot No.	Mfg. No.	Weight
"FN" SERIES: LEAD		
488-43005	FNc005	5 grams
488-43010	FNc010	10 grams
488-43015	FNc015	15 grams
488-43020	FNc020	20 grams
488-43025	FNc025	25 grams

Ascot No.	Mfg. No.	Weight
"FN" SERIES: LEAD		
488-43030	FNc030	30 grams
488-43035	FNc035	35 grams
488-43040	FNc040	40 grams
488-43045	FNc045	45 grams
488-43050	FNc050	50 grams

QUANTITY: 25 per box

MC SERIES COATED LEAD CLIP-ON WHEEL WEIGHTS



Ascot No.	Mfg. No.	Weight
"MC" SERIES: LEAD		
488-49025	MCc025	0.25 oz.
488-49050	MCc050	0.50 oz.
488-49075	MCc075	0.75 oz.
488-49100	MCc100	1.00 oz.
488-49125	MCc125	1.25 oz.
488-49150	MCc150	1.50 oz.

Ascot No.	Mfg. No.	Weight
"MC" SERIES: LEAD		
488-49175	MCc175	1.75 oz.
488-49200	MCc200	2.00 oz.
488-49225	MCc225	2.25 oz.
488-49250	MCc250	2.50 oz.
488-49275	MCc275	2.75 oz.
488-49300	MCc300	3.00 oz.

QUANTITY: 25 per box

IMPORT ZINC COATED CLIP-ON WHEEL WEIGHTS

Ascot No.	Mfg. No.	Weight	Ascot No.	Mfg. No.	Weight
REG IMPORT ZINC COATED			FN IMPORT ZINC COATED		
488-81025	P025Z	.25 Oz.	488-84010	FNZ010	10 Gram
488-81050	P050Z	.50 Oz.	488-84015	FNZ015	15 Gram
488-81075	P075Z	.75 Oz.	488-84020	FNZ020	20 Gram
488-81100	P100Z	1.00 Oz.	488-84025	FNZ025	25 Gram
488-81125	P125Z	1.25 Oz.	488-84030	FNZ030	30 Gram
488-81150	P150Z	1.50 Oz.	488-84035	FNZ035	35 Gram
488-81175	P175Z	1.75 Oz.	488-84040	FNZ040	40 Gram
488-81200	P200Z	2.00 Oz.	488-84045	FNZ045	45 Gram
488-81225	P225Z	2.25 Oz.	488-84050	FNZ050	50 Gram
488-81250	P250Z	2.50 Oz.	T IMPORT ZINC COATED		
488-81275	P275Z	2.75 Oz.	488-86025	TZ025	.25 Oz.
488-81300	P300Z	3.00 Oz.	488-86050	TZ050	.50 Oz.
MC IMPORT ZINC COATED			488-86075	TZ075	.75 Oz.
488-83025	MC025Z	.25 Oz.	488-86100	TZ100	1.00 Oz.
488-83050	MC050Z	.50 Oz.	488-86125	TZ125	1.25 Oz.
488-83075	MC075Z	.75 Oz.	488-86150	TZ150	1.50 Oz.
488-83100	MC100Z	1.00 Oz.	488-86175	TZ175	1.75 Oz.
488-83125	MC125Z	1.25 Oz.	488-86200	TZ200	2.00 Oz.
488-83150	MC150Z	1.50 Oz.	488-86225	TZ225	2.25 Oz.
488-83175	MC175Z	1.75 Oz.	488-86250	TZ250	2.50 Oz.
488-83200	MC200Z	2.00 Oz.	488-86275	TZ275	2.75 Oz.
488-83225	MC225Z	2.25 Oz.	488-86300	TZ300	3.00 Oz.
488-83250	MC250Z	2.50 Oz.			
488-83275	MC275Z	2.75 Oz.			
488-83300	MC300Z	3.00 Oz.			

LEAD, ZINC & STEEL WHEEL WEIGHTS

WHEEL WEIGHT ROLL WIRE HANGERS

- Hanging racks for adhesive wheel weights
- Fits most popular wheel balancers
- Single and double roll racks available
- Heavy duty steel wire construction
- Compatible with most adhesive wheel weight rolls



Ascot No.	Mfg. No.	Description
486-31283	WWRR-1	Single Roll Wheel Weight Wire Hanger
486-31284	WWRR-2	Double Roll Wheel Weight Wire Hanger

4-SLOT WHEEL WEIGHT ROLL STAND CONVERSION KIT

- Convert a 4-slot wheel weight stand into a 6-slot wheel weight stand
- Left and right slots and hardware included
- All metal construction
- Easy to assemble



Ascot No.	Mfg. No.	Description
486-31285	WWR-2	4-Slot Wheel Weight Roll Stand Conversion Kit

METAL WHEEL WEIGHT RACK

- All-metal construction
- 8 shelves
- Includes dividers
- 64 weight locations
- Square tube to support the rack
- 52"H x 27-1/2"W x 8"D



486-31280 Metal Wheel Weight Rack

Ascot No.	Mfg. No.	Description
486-31280	MFR	Metal Wheel Weight Rack

ADHESIVE WHEEL WEIGHT ROLL STANDS

- All-metal construction
- Accommodates three & four rolls
- Floor mount
- Easy to assemble
- Adapter for smaller rolls



486-31282 4-Slot Adhesive Wheel Weight Roll Stand

486-31281 3-Slot Adhesive Wheel Weight Roll Stand

Ascot No.	Mfg. No.	Description
486-31281	WWR-3	3-Slot Adhesive Wheel Weight Roll Stand
486-31282	WWR-4	4-Slot Adhesive Wheel Weight Roll Stand

ADHESIVE WHEEL WEIGHTS

ASCOT RIM GAUGE

- Convenient and economical gauge that guides you to the correct wheel weight application
- Helpful with alloy wheels and thinner high strength steel wheels that have numerous new rim configurations

Ascot No.	Mfg. No.	Description
486-75011	ARGP1	Ascot Rim Gauge For Passenger Cars

486-75011
Ascot Rim Gauge

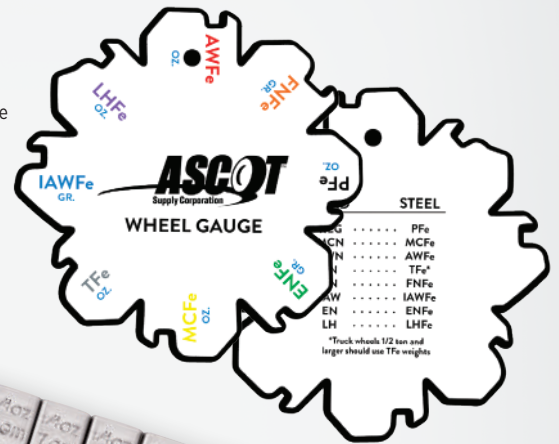

PERFECT QUIK-STIK™ SEGMENTED ADHESIVE STYLE WHEEL WEIGHTS

- Only pre-cut, pre-taped weight
- No cutting, no pre-contouring and no waste
- Each segment is stamped with the actual weight in ounces and grams

Ascot No.	Mfg. No.	Description
484-00006	CL6	Lead Adhesive Wheel Weight: 6 oz. (30 Strips per Box)
484-00112	CL12	Lead Adhesive Wheel Weight: 12 oz. (8 Strips per Box)
484-10720	100720	Lead Adhesive Wheel Weight: 3 oz. (60 Strips per Box)
484-11360	100360	Lead Adhesive Wheel Weight: 3 oz. (30 Strips per Box)
484-13360	200624	Lead Adhesive Wheel Weight: 3 oz. (52 Strips per Box)
484-30360	300360	Lead Adhesive Wheel Weight: 6 oz. (30 Strips per Box)

PERFECT QUIK-STIK™ SEGMENTED ADHESIVE STYLE STEEL WHEEL WEIGHTS

- Only pre-cut, pre-taped weight
- No cutting, no pre-contouring and no waste
- Each segment is stamped with the actual weight in ounces and grams

Ascot No.	Mfg. No.	Description
484-20576	200576FE	1/4 oz. Steel Adhesive Wheel Weight: 3 oz. (48 Strips per Box)
484-30224	300224FE	1/2 oz. Steel Adhesive Wheel Weight: 4 oz. (28 Strips per Box)
484-31360	300360ST	Steel Adhesive Wheel Weight: 6 oz. Strips (30 Strips per Box)
484-22576	200576FEBLK	1/4 oz. Black Steel Adhesive Wheel Weight: 3 oz. (48 Strips per Box)
484-32224	300224FEBLK	1/2 oz. Black Steel Adhesive Wheel Weight: 4 oz. (28 Strips per Box)

STEEL SEGMENTED ADHESIVE STYLE WHEEL WEIGHTS

- Pre-cut weights
- No cutting, no pre-contouring and no waste
- Each segment is stamped with the actual weight in ounces
- US white "quick" tape

Ascot No.	Mfg. No.	Description
484-16001	1184	1 oz. Steel Adhesive Wheel Weights: 1 oz. Strips, 4 Segments (18 Strips per Box)
484-17026	14308	1/4 oz. Steel Adhesive Wheel Weights with Plastic Powder Coating: 1/4 oz. Strips, 8 Segments (30 Strips per Box)
484-17127	12187	1/2 oz. Steel Adhesive Wheel Weights: 1/2 oz. Strips, 7 Segments (18 Strips per Box)
484-37026	14308B	1/4 oz. Black Steel Adhesive Wheel Weights with Black Powder Coating: 1/4 oz. Strips, 8 Segments (30 Strips per Box)
484-67026	24308B	1/2 oz. Black Steel Adhesive Wheel Weight: 3.5 oz. Strip (18 Strips per Box)
484-77026	34308B	1 oz. Black Steel Adhesive Wheel Weight: 4 oz. Strip (18 Strips per Box)



ADHESIVE WHEEL WEIGHTS



PLOMBCO STEEL ADHESIVE WHEEL WEIGHTS

- Only pre-cut, pre-taped weight
- No cutting, no pre-contouring and no waste
- Each segment is stamped with the actual weight in ounces and grams

Ascot No.	Mfg. No.	Description
484-28408	408FE-28	Steel Adhesive Wheel Weight: 4 oz. (28 Strips per Box)
484-28428	VL408FEB-28	Value Line Black Steel Adhesive Wheel Weight: 4 oz. (28 Strips per Box)
484-31234	312Fe-30	Steel Adhesive Wheel Weight: 3 oz. (30 Strips per Box)
484-40848	408Fe-48	408Fe-48 Steel Adhesive Wheel Weight: 4 oz. (48 Strips/Box)
484-50615	506Fe-15	Steel Adhesive Wheel Weight: 6 oz. (15 Strips per Box)
484-52312	312FE-52	Steel Adhesive Wheel Weight: 3 oz. (52 Strips per Box)

STEEL ADHESIVE WHEEL WEIGHTS

Ascot No.	Mfg. No.	Description
484-10100	FSF101C	1/4 oz. Adhesive Wheel Weight: 3 oz. (48 Strips per Box)
484-10101	FSF101B	1/4 oz. Black Steel Adhesive Wheel Weight: 3 oz. (48 Strips per Box)
484-10102	FSF101CP	1/4 oz. Adhesive Wheel Weight: 3 oz. (48 Strips per Box) - Paper Backing
484-10200	FSF102C	1/2 oz. Adhesive Wheel Weight: 3 oz. (48 Strips per Box)
484-10201	FSF102B	1/2 oz. Black Steel Adhesive Wheel Weight: 3 oz. (48 Strips per Box)
484-10300	FSF103C	1 oz. Adhesive Wheel Weight: 4 oz. (36 Strips per Box)
484-10301	FSF103B	1 oz. Black Steel Adhesive Wheel Weight: 4 oz. (36 Strips per Box)
484-10400	FSF104C	2 oz. Adhesive Wheel Weight: 6 oz. (18 Strips per Box)

ADHESIVE WHEEL WEIGHTS

PLOMBCO STEEL ADHESIVE WHEEL WEIGHT ROLLS

- Only pre-cut, pre-taped weight
- No cutting, no pre-contouring and no waste
- Each segment is stamped with the actual weight in ounces and grams

Ascot No.	Mfg. No.	Description
484-35320	320Fe	Steel Adhesive Wheel Weight Roll: 20 lb., .25 oz. Segments
484-35420	320Fe-CW	Steel Adhesive Wheel Weight Roll: .25 oz Segments, Cold Weather Adhesive
484-42010	420Fe	Steel Adhesive Wheel Weight Roll: 20 lb., .50 oz. Segments

484-35320
Steel Adhesive Wheel Weight Roll: 20 lb., .25 oz. Segments



484-35420
Steel Adhesive Wheel Weight Roll: .25 oz Segments, Cold Weather Adhesive

PERFECT STEEL ADHESIVE WHEEL WEIGHT ROLLS

- **FAMILIAR DESIGN:** Features all of the same standard steel QuikStik characteristics
- Low profile height for tighter clearance applications
- 3-year aftermarket proven powder coating
- All-Weather™ white tape with instant stick
- Only use the amount of weight you need each time you balance
- No cutting and no measuring
- Rolled weights are more efficient and help reduce waste

Ascot No.	Mfg. No.	Description
484-21576	200576FER	0.25 oz. (704 Segments)
484-21624	200624STR	.25 oz. (1280 Segments)
484-32360	300360STR	.5 oz. (640 Segments)
484-23576 NEW!	200576FERBLK	0.25 Oz. (704 Segments) - Black
484-32224 NEW!	300224FER	0.50 Oz. (640 Segments)
484-33224 NEW!	300224FERBLK	0.50 Oz. (640 Segments) - Black



484-21576
Perfect Steel Adhesive Wheel Weight Rolls (1/4 oz., 704 Segments)

STEEL ADHESIVE WHEEL WEIGHT ROLLS

- Oversized white paper tape
- **Easy to peel**
- Easy to tear by hand
- Available in grey steel or black steel
- 3 rolls per case

Ascot No.	Mfg. No.	Description
484-51500	AVL315FeB	Black Steel Adhesive Roll: 1/4 oz. Segments (960/roll)
484-51501	AVL315FeS	Grey Steel Adhesive Roll: 1/4 oz. Segments (960/roll)
484-61500	AVL414FeB	Black Steel Adhesive Roll: 1/2 oz. Segments (480/roll)
484-61501	AVL415FeS	Grey Steel Adhesive Roll: 1/2 oz. Segments (480/roll)
484-71500	AVL515FeB	Black Steel Adhesive Roll: 1 oz. Segments (230/roll)
484-71501	AVL515FeS	Steel Adhesive Roll: 1 oz. Segments (230/roll)

484-51501
Grey Steel Adhesive Roll: 1/4 oz. Segments



484-61500
Black Steel Adhesive Roll: 1/2 oz. Segments

STEEL ADHESIVE WHEEL WEIGHT ROLLS

- Simply use the amount of weight you need each time you balance
- Convenient pull and rip design
- No cutting and no measuring
- **Easy to Peel**
- Rolled weights are more efficient and help reduce waste
- Plastic coated
- US white "quick" tape

Ascot No.	Mfg. No.	Description
484-47026	145KG	5kg Steel Adhesive Wheel Weight Roll: 1/4 oz. Segments (700 Segments per Roll)

484-47026
5kg Steel Adhesive Wheel Weight Roll (1/4 oz., 700 Segments)



WHEEL BALANCING TOOLS & ACCESSORIES



COUNTERACT BALANCING BEADS

• Perfect balance - perfect wear • Clean, trouble free balancing micro-beads provide continuous self-adjusting balance • No clumping • Just open the outside package and throw the inside bag into the tire • Method allows the use of an air blaster to seat the tire on the rim without contaminating the seating area • Air blaster pressure inside the tire will collapse the bag containing Counteract Balancing Beads or the package will break open and release its contents soon after driving • Available in application sizes from half ton vehicles to heavy trucks • All packaging is color coded to tire size on application chart



- INCREASE TIRE LIFE
- IMPROVE FUEL ECONOMY
- TPMS COMPATIBLE
- REDUCE VIBRATIONS
- TROUBLE FREE
- ENVIRONMENTALLY FRIENDLY
- REDUCE MAINTENANCE COSTS
- GUARANTEED

Ascot No.	MFG. NO.	Description	Qty./Case
451-00203	3 oz. BP	3 oz. Bag in Bag	96
451-00204	4 oz. B	4 oz. Bag in Bag	92
451-00205	5 oz. B	5 oz. Bag in Bag	76
451-00206	6 oz. B	6 oz. Bag in Bag	64
451-00208	8 oz. B	8 oz. Bag in Bag	52
451-00210	10 oz. B	10 oz. Bag in Bag	40
451-00212	12 oz. B	12 oz. Bag in Bag	36
451-00214	14 oz. B	14 oz. Bag in Bag	32
451-00216	16 oz. B	16 oz. Bag in Bag	28

COUNTERACT INJECTOR PUMP

- All-new design is constructed from the highest quality of materials and designed specifically for its purpose
- Allows for a more efficient installation of Counteract Balancing Beads into a tire through the valve stem
- Holds 20 oz. of Counteract Balancing Beads at a time, allowing for quick, easy, and safe injection of the product
- No need to break the tire bead
- Quick injection
- Allows the user to add small amounts to "fine-tune a balance"



Ascot No.	Mfg. No.	Description
451-00014	CBB-IP	Counteract Injector Pump

WHEEL BALANCING TOOLS & ACCESSORIES

ECO BALANCE BALANCING BEADS

- Eco-friendly complete wheel assembly internal balancing agent
- Increase tire life with even tread wear
- Lower tire operating temperatures
- TPMS Compatible
- Reduce maintenance with easy installation throw-in-bag
- Improve fuel economy by reducing rolling resistance
- Easy to use application chart
- Remain balanced for the life of the tire

ECO BALANCE XL BALANCING BEADS

- Eco-friendly balancing beads
- Extra large beads for extreme balancing conditions
- Convenient, pre-measured bags
- Sizes range from 3 oz. up to 20 oz.
- Contains throw in bag and valve cap
- Improve fuel economy, increase tire life & reduce vibrations

451-01203
3 oz.



SMALL
1MM BEAD
SIZE

451-01204
4 oz.

451-01206
6 oz.



451-01208
8 oz.

451-01210
10 oz.



451-01212
12 oz.

451-01214
14 oz.



451-01216
16 oz.

XL
2.55-3MM
BEAD SIZE



451-00618
EcoBalance XL
18 lb. bucket

Ascot No.	Mfg. No.	Description	Qty./Case
451-01203	3 oz. BP-EB	3 oz. Bag in Bag	96
451-01204	4 oz. B-EB	4 oz. Bag in Bag	92
451-01206	6 oz. B-EB	6 oz. Bag in Bag	64
451-01208	8 oz. B-EB	8 oz. Bag in Bag	52
451-01210	10 oz. B-EB	10 oz. Bag in Bag	40
451-01212	12 oz. B-EB	12 oz. Bag in Bag	36
451-01214	14 oz. B-EB	14 oz. Bag in Bag	32
451-01216	16 oz. B-EB	16 oz. Bag in Bag	28

Ascot No.	Mfg. No.	Description	Qty./Case
451-00618	ECOXL18LB	18 lb. Bucket	N/A

WHEEL BALANCING TOOLS & ACCESSORIES

PERFECT SELF-ADJUSTING BALANCE



451-00200

MAGNUM+ BALANCING COMPOUND

- An advanced technology dry tire balancing compound, with superior tire balancing properties
- Formulated from specially-processed multiple-density materials
 - Provides continuous and lasting tire balancing for standard, low-profile and wide-base medium truck tires and heavy duty light truck tires
- No more time-consuming and expensive mechanical balancing, perfect self-adjusting balance in all your tires, less vehicle wear and tear, easier maintenance and less driver fatigue

Ascot No.	Mfg. No.	QTY./CASE
451-00100	LTP100	36
451-00150	LTP150	36
451-00200	LTP200	24
451-00250	MTP250	24
451-00300	MTP300	20
451-00400	MTP400	12
451-00500	MTP500	12

2X MORE ABSORPTION POWER



451-32016

EQUAL FLEXX DROP-IN BAGS

- IMI EQUAL FLEXX™ is an adaptive, internal wheel-end balancing solution that reduces fuel and tire costs by reducing vibration from the wheel end
- Developed in partnership with the foremost experts in vibration analysis and testing, its soft, dry particles are engineered to continuously balance tires, creating a smoother ride and more even tire wear for the life of the tire
- FLEXX will never damage the tire casing, wheel or TPMS units.
- It does not void tire manufacturer warranties
- 2x more absorption power, up to 15% better performance, easiest to use

Ascot No.	Mfg. No.	Description	Qty./Case
451-32016	EQFXWC32	16 Oz. EQUAL FLEXX Drop-In Bag - 32 Bags - W Pkgs.	32
451-40004	EQFXEC40	4 Oz. EQUAL FLEXX Drop-In Bag - 40 Bags - E Pkgs.	40
451-40006	EQFXDC40	6 Oz. EQUAL FLEXX Drop-In Bag - 40 Bags - D Pkgs.	40
451-40008	EQFXCC40	8 Oz. EQUAL FLEXX Drop-In Bag - 40 Bags - C Pkgs.	40
451-40010	EQFXBC40	10 Oz. EQUAL FLEXX Drop-In Bag - 40 Bags - B Pkgs.	40
451-40012	EQFXAC40	12 Oz. EQUAL FLEXX Drop-In Bag - 40 Bags - A Pkgs.	40
451-40016	EQFXFC40	3 Oz. EQUAL FLEXX Drop-In Bag - 40 Bags - F Pkgs.	40

INTRODUCING THE NEW



Counteract[®] Balancing App & **WHEEL DEALER REWARDS ADVANTAGE**

Download our new app for quick Counteract calculations for any vehicle. Plus, access the Wheel Advantage Dealer Rewards Program, rewarding dealers with redeemable points for Counteract products and merchandise.

What's In Store?

Our innovative program offers you the chance to earn valuable reward points that seamlessly translate into a treasure trove of Counteract Merchandise.

Collect QR Code vouchers found in full cases of Counteract Balancing Beads[®], scan and trade them for some fabulous rewards.



Case of Beads (3oz to 20oz)
REDEMPTION VALUE
10,000 Points



Mounting Lube - 4x8lb
REDEMPTION VALUE
8,000 Points



Injection Pump
REDEMPTION VALUE
7,000 Points



Scan to
download
the app



For a list of all rewards and more details,
download the Counteract Balancing app

*Please note that participation in the Wheel Advantage Dealer Rewards Program is at the discretion of individual distributors. As such, not all distributors may choose to participate in the program. Consequently, Counteract products distributed through non-participating distributors will not include the Wheel Advantage Reward QR Code Vouchers.

magnum+

The Perfect Balance
Between Profits and Efficiency



THE ORIGINAL AND THE BEST

Checkpoint®

Put
Safety
Into Motion



by MARTINS

WHEEL BALANCING TOOLS & ACCESSORIES

PREMIUM HEAVY DUTY PROFESSIONAL WHEEL WEIGHT HAMMER

- Heavy duty construction
- Black coated handles with red highlight
- Designed for use on coated wheel weights
- Will not mark alloy wheels
- *Replaceable plastic head available*
- **Made in TW**

Ascot No.	Mfg. No.	Description
486-33581	3358-B	Premium Heavy Duty Professional Wheel Weight Hammer
486-33584	335804	Replacement Head



486-33581
Premium Heavy Duty Professional Wheel Weight Hammer

486-33584
Replacement Head

HEAVY DUTY WHEEL WEIGHT HAMMER

- Heavy-duty construction
- Designed for use on coated wheel weights
- Will not mark alloy wheels
- *Replaceable plastic head available*
- **Made in TW**



Ascot No.	Mfg. No.	Description
486-33580	3358	Heavy Duty Wheel Weight Hammer
486-33584	335804	Replacement Head



486-33580
Heavy Duty Wheel Weight Hammer

486-33584
Replacement Head

ECONOMY CHROME WHEEL WEIGHT HAMMER

- The industry standard for passenger car wheel weight tools
- **Made in TW**

Ascot No.	Mfg. No.	Description
486-00011	P-1	Economy Chrome Wheel Weight Hammer



486-00011
Economy Chrome Wheel Weight Hammer

PREMIUM FIBERGLASS WHEEL WEIGHT HAMMER

- Used to easily install and remove all types of steel and zinc clip-on wheel weights
- Standard with large replaceable hook for prying
- Fiberglass shaft for added durability
- The hook is made from cold rolled steel
- Slip-resistant, ergonomic grip reduces arm strain & fatigue
- The striking face has a non-marring, surface protective medium-hard replaceable tip
- *Replacement hooks and caps available*
- **MADE IN THE USA**

Ascot No.	Mfg. No.	Description
486-11000	P110	Premium Fiberglass Wheel Weight Hammer
486-11006	P110-6	Replacement Tip for P110-T Premium Truck Wheel Weight Hammer



486-11000
Premium Fiberglass Wheel Weight Hammer

486-11006
Replacement Tip

WHEEL BALANCING TOOLS & ACCESSORIES



486-00222
Euro-Style
Wheel Weight
Hammer

EURO-STYLE WHEEL WEIGHT HAMMER

- Heavy commercial duty design
- Coated handles for comfort
- Nickel-plated vanadium

Ascot No.	Mfg. No.	Description
486-00222	P-2C	Euro-Style Wheel Weight Hammer



486-00233
Coated Wheel
Weight Hammer

486-00133
Replacement
Head

SOFT HEAD WHEEL WEIGHT HAMMER

- Protects valuable wheels from damage
- Features replaceable plastic head

Ascot No.	Mfg. No.	Description
486-00233	P-3B	Soft Head, Soft Claw Wheel Weight Hammer
486-00133	P-3H	Replacement Head for P-3B Wheel Weight Hammer



486-00044
Heavy Duty
Adhesive
Wheel Weight
Removal Tool

HEAVY DUTY ADHESIVE WHEEL WEIGHT REMOVAL TOOL

- Light weight and easy to use
- Easy and quick to remove stick-on wheel weights without damaging rims
- The plastic cover of the jaws can protect the alloy rims from damaging or scratching
- Adjustable jaws for different types and sizes of wheel weights
- *Replacement plastic tips available separately*
- **Made in TW**

LIGHT IN
WEIGHT

EASY
TO USE

Ascot No.	Mfg. No.	Description
486-00044	P4	Heavy Duty Adhesive Wheel Weight Removal Tool
486-00144	P4R	Replacement Tips for P4 (2-Pack)



482-09011
Rim Width Caliper

RIM WIDTH CALIPER

- Measures wheel width in inches
- *For use with all COATS automotive balancers*
- **Equivalent to COATS 309011**

Ascot No.	Mfg. No.	Description
482-09011	8309011	Rim Width Caliper

WHEEL BALANCING TOOLS & ACCESSORIES

RED HEAVY DUTY ADHESIVE WHEEL WEIGHT SCRAPER

- 265mm long (large) made for gently removing adhesive wheel weights with minimal damage. Additional applications; removing decals, emblems, and body molding without scratching or damaging metal, glass, or paint
- Lightweight, high-impact resistant nylon plastic material for maximum durability, resistant to deforming over time, and helps avoid scratching while removing tire wheel weights
- or other stubborn material
- Sturdy design for a prolonged lifespan while in the field. A comfortable and baffle grip provides the user more control and absorbs vibration from consistent hammer blows, allowing for more precision work
- Solvent-resistant and the blade is able to be re-sharpened.
- Adaptable to multiple-sized wheels

NEW

Ascot No.	Mfg. No.	Description
486-71512	AS-002	Red Heavy Duty Adhesive Wheel Weight Scraper - 10.4" Length

486-71512
Red Heavy Duty Adhesive Wheel Weight Scraper - 10.4" Length

486-71510
Red Heavy Duty Adhesive Wheel Weight Scraper



486-71511
Black Heavy Duty Adhesive Wheel Weight Scraper



HEAVY DUTY ADHESIVE WHEEL WEIGHT SCRAPERS

- Knobbed handle to prevent hand from slipping while removing wheel weights
- Made of high impact plastic
- For use with stick-on wheel weights

Ascot No.	Mfg. No.	Description
486-71510	N/A	Red Heavy Duty Adhesive Wheel Weight Scraper
486-71511	N/A	Black Heavy Duty Adhesive Wheel Weight Scraper



GT FORCE TWO-IN-ONE WHEEL WEIGHT APPLICATION AND REMOVAL TOOL

- Eliminates finger injury by eliminating the need for a hammer
- One tool for both installation and removal
- Replaceable heads available
- No more damaging expensive wheels with a hammer

NEW



Ascot No.	Mfg. No.	Description
486-48301	GTF-01	GT Force Two-In-One Wheel Weight Application And Removal Tool

486-48301
GT Force Two-In-One Wheel Weight Application And Removal Tool

GT FORCE WHEEL WEIGHT TOOL IN ACTION



WHEEL BALANCING TOOLS & ACCESSORIES



483-40800
Soft Grip
Quick Nut
- 40 x 8

SOFT GRIP QUICK NUT - 40 X 8

- Improved design, essential wheel balancer tooling
- New ergonomic design with soft-touch handle
- New metal alloy threaded jaws last longer
- Larger bearing surface allows for higher torque
- Pressure ring is always attached to the quick nut (a must for quick plate/flange plate use)
- Optimized glide prevents fast wear of the thread shaft
- Redesigned, heavy duty pressure cup
- Improved quick action mechanism prevents opening under load
- Lower housing height for shorter shafts and larger profile wheels... always grabs the thread
- Lighter weight, easier to handle due to lower housing height



483-40806
Steel ProGrip QuickNut
40 x 8 with Handles
and Pressure Cup

STEEL PROGRIP QUICKNUT WITH HANDLES AND PRESSURE CUP

- Essential wheel balancer tooling
- Clamping device speeds wheel mounting process on balancers
- Heavy duty steel design solution for Road Force balancers



483-40301
SoftGrip Quick Nut
40 x 3 with Handles



483-40401
SoftGrip Quick Nut
40 x 4 with Handles



483-40801
SoftGrip Quick Nut
40 x 8 with Handles

SOFTGRIP QUICKNUTS WITH HANDLES

- Essential wheel balancer tooling
- Upgraded threaded jaws with bigger bearing surface allows higher torque pressure
- Softgrip clamping device will not open under load
- New alloy metal jaws provides longer life for threaded jaws
- Heavier duty pressure cup
- Torque ring is ever present - removal not required for use with pressure cup
- Lower overall housing height enables use with quick or flange plates on shorter shafts

Ascot No.	Mfg. No.	Description
483-40301	HW125 403 001	SoftGrip Quick Nut 40 x 3 with Handles
483-40401	HW125 404 001	SoftGrip Quick Nut 40 x 4 with Handles
483-40801	HW125 408 001	SoftGrip Quick Nut 40 x 8 with Handles

483-40091
Light Truck
Cone Kit
40mm

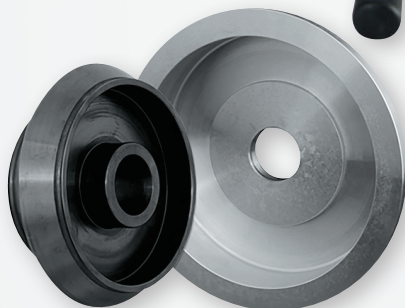
**LIGHT TRUCK CONE KIT 40MM**

- Covers hub ranges 120mm-174mm
- Kit includes a cone and distance spacer
- Works on all balancer makes and models with 40mm shaft

Ascot No.	Mfg. No.	Description
483-40091	HW150 400 091	Light Truck Cone Kit 40mm

WHEEL BALANCING TOOLS & ACCESSORIES



PRESSURE CUP FOR SOFT GRIP QUICKNUTS

- Must be used with rubber ring (HW190 008 005)
- Works with all Soft Grip QuickNuts (Not standard QuickNuts)
- Rigid, heavy duty design prevents flex during balancer spin
- Long lasting, hard plastic composition
- Snap connects easily to Soft Grip QuickNut



483-08065
Pressure Cup for Soft Grip QuickNuts

Ascot No.	Mfg. No.	Description
483-08065	HW190 008 065	Pressure Cup for Soft Grip QuickNuts

PROGRIP PRESSURE CUP

- Pressure Cup for all ProGrip Quicknuts 40mm, 38mm, 36mm, 28mm
- HW143 403 003, HW143 403 006, HW143 383 003, HW143 383 006, HW143 363 003, HW143 363 006, HW143 283 003, HW143 283 006, HW143 404 003, HW143 404 006, HW143 285 006, HW143 405 006, HW140 403 033, HW140 404 033



483-08002
ProGrip Pressure Cup

Ascot No.	Mfg. No.	Description
483-08002	HW190 008 002	ProGrip Pressure Cup

4.5 IN. RUBBER RING FOR HUNTER QUICK RELEASE NUT

- For use with TMRWB1753531 pressure cup
- To prevent the marring of wheels
- Rubber ring for Hunter Quick Release Nut
- Replaces OEM Hunter #106-82-2



483-16822
4.5 in. Rubber Ring for Hunter Quick Release Nut

Ascot No.	Mfg. No.	Description
483-16822	WB106822	4.5 in. rubber ring for Hunter Quick Release Nut

6 IN. RUBBER RING FOR HUNTER QUICK RELEASE NUT

- Replaces Hunter 106-157-2
- For Use On All Hunter Wheel Balancers
- To Prevent Marring Of The Wheel During Wheel Balancing Service When Using A Pressure Cup
- For Use With Hunter Steel Wing Nuts And Quick Nuts
- For Use With TMRWB1753921 Pressure Cup



483-16572
6 in. Rubber Ring for Hunter Quick Release Nut

Ascot No.	Mfg. No.	Description
483-16572	WB1061572	6 in. rubber ring for Hunter Quick Release Nut

WHEEL BALANCING TOOLS & ACCESSORIES



483-08005
Rubber Cover for
5" Pressure Cup

RUBBER COVER FOR 5" PRESSURE CUP

- Provides rubberized protection between wheel rim and pressure cup

Ascot No.	Mfg. No.	Description
483-08005	HW190 008 005	Rubber Cover for 5" Pressure Cup



483-08027
Pressure Ring
for all ProGrip
QuickNuts

PRESSURE RING FOR ALL PROGRIP QUICKNUTS

- *Pressure Ring must be present on ProGrip QuickNuts when using Quick or Flange Plates*
- Without the pressure ring, the clamping device does not provide enough torque pressure to press rim on cones/collets evenly and consistently elicits inaccurate balancing results

Ascot No.	Mfg. No.	Description
483-08027	HW190 008 027	Pressure Ring for all ProGrip QuickNuts



483-40062
Toyota
Precision
Collet

TOYOTA PRECISION COLLET

- Precision-designed, application-specific solution for balancing Toyota Truck wheels
- Problem-solving precision collet for Toyota Tundra, Sequoia, Tacoma, 4Runner, FJ as well as Lexus SUV applications and more

Ascot No.	Mfg. No.	Description
483-40062	HW160 400 062	Toyota Precision Collet



483-40060
Ford
Precision
Collet

FORD PRECISION COLLET

- Precision-designed, application-specific solution for balancing Ford light truck and SUV applications
- Problem-solving precision collet for Ford F150, Expedition and Lincoln Navigator applications

Ascot No.	Mfg. No.	Description
483-40060	HW160 400 060	Ford Precision Collet

WHEEL BALANCING TOOLS & ACCESSORIES



PROCOLLET KIT 40MM

- Two-sided, low taper collets
- Standard cone upgrade
- Low taper provides improved centering at wheel hub for more accurate balancing results
- Clad wheel Problem Solver

Ascot No.	Mfg. No.	Description
483-40110	HW150 400 110	ProCollet Kit 40mm



483-40110
ProCollet Kit 40mm

PRO CENTERING KIT VII

- OE precision collets and dual sided, low taper collets for improved centering
- **PROBLEM SOLVER FOR FORD TRUCK APPLICATIONS:** F-150, Expedition, Navigator
- **PROBLEM SOLVER FOR TOYOTA TRUCK APPLICATIONS:** Tundra, Tacoma, Sequoia, 4Runner, FJ Cruiser
- Clad wheel problem solver
- No wheel hub interference (clad wheels)
- *For best results, use with a lug adapter system (quick plates/flange plates)*

Ascot No.	Mfg. No.	Description
483-40132	HW150 400 132	Pro Centering Kit VII

483-40132
Pro Centering Kit VII



NORTH AMERICAN FLANGE PLATE KIT 40MM

- Replicates vehicle wheel lug mount on the balancer
- Provides consistent, even pressure when mounting wheel on cones/collets for precision balancing results

Ascot No.	Mfg. No.	Description
483-99409	HW200 299 409	North American Flange Plate Kit 40mm



483-99409
North American Flange Plate Kit 40mm

MISC. AUTO/FLEET SERVICE PRODUCTS



309-00404
Tesla Jack Pads



RUBBER JACK PADS FOR TESLA VEHICLES

- Lifting jack pads for Tesla models
- Set of four in convenient carrying case
- Protect the vehicle, battery and paint from damage
- Can be used with floor jack or 2-post lifts
- Top piece fits into designated factory lift points

Ascot No.	Mfg. No.	Description
309-00404	TJP4	Tesla Jack Pads - Set of 4 with case



309-00405
Tesla Model Y
Jack Pads

SET OF 4 RUBBER JACK PADS FOR TESLA MODEL Y VEHICLES

- Lifting jack pads for 2023 - 2024 Tesla Model Y vehicles manufactured in the Texas plant
- Set of four in convenient carrying case
- Protect the vehicle, battery and paint from damage
- Can be used with floor jack or 2-post lifts
- Top piece fits into designated factory lift points



Ascot No.	Mfg. No.	Description
309-00405	TJP4-Y	Rubber Jack Pads for Tesla Model Y Vehicles - Set of 4



MISC. AUTO/FLEET SERVICE PRODUCTS

RUBBER LIFT PAD (4" X 4")

- **RUBBER PAD DIMENSIONS:** 4" x 4"
- **Kit of four rubber pads**
- Replacement pads for Challenger CL9 and CL10 lifts

Ascot No.	Mfg. No.	Description
309-00009	JOK090	Rubber Lift Pad - 4" x 4"

309-00009
Rubber Lift Pad
(4" x 4")



RUBBER LIFT PAD (3.25" X 4")

- **RUBBER PAD DIMENSIONS:** 3.25" x 4"
- **Kit of four rubber pads**
- Replacement pads for Rotary SPO10, SPO12 lifts

Ascot No.	Mfg. No.	Description
309-00022	JOK22D	Rubber Lift Pad - 3.25" x 4"

309-00022
Rubber Lift Pad
(3.25" x 4")



RUBBER LIFT PAD (6.25" ROUND SLIP ON)

- **RUBBER PAD DIMENSIONS:** 6.25" Round Slip On
- **Kit of four rubber pads**
- Replacement pads for ALM Lifts

Ascot No.	Mfg. No.	Description
309-00006	JOK06M	Rubber Lift Pad - 6.25" Round Slip On

309-00006
Rubber Lift Pad (6.25"
Round Slip On)



RUBBER LIFT PAD (5.25" ROUND)

- **RUBBER PAD DIMENSIONS:** 5.25" round
- **Kit of four rubber pads**
- Replacement pads for Challenger CL10, Quality lifts

Ascot No.	Mfg. No.	Description
309-00014	JOK14O	Rubber Lift Pad - 5.25" Round

309-00014
Rubber Lift Pad
(5.25" Round)



RUBBER LIFT PAD (5" ROUND)

- **RUBBER PAD DIMENSIONS:** 5" round
- **Kit of four rubber pads**
- Replacement pads for Nussbaum lifts

Ascot No.	Mfg. No.	Description
309-00003	JOK03M	Rubber Lift Pad - 5" Round

309-00003
Rubber Lift Pad
(5" Round)



MISC. AUTO/FLEET SERVICE PRODUCTS



309-00005
Rubber Lift Pad
(4" x 5")

RUBBER LIFT PAD (4" X 5")

- **RUBBER PAD DIMENSIONS:** 4" x 5"
- **Kit of four rubber pads**
- Replacement pads for Ammco, Ben Pearson lifts

Ascot No.	Mfg. No.	Description
309-00005	JOK05M	Rubber Lift Pad - 4" x 5"



309-00007
Rubber Lift Pad
(5" x 5")

RUBBER LIFT PAD (5" X 5")

- **RUBBER PAD DIMENSIONS:** 5" x 5"
- **Kit of four rubber pads**
- Replacement pads for Forward, Worth, American, Gemini, Grand, Tuxedo, Eagle, Whip lifts

Ascot No.	Mfg. No.	Description
309-00007	JOK07M	Rubber Lift Pad - 5" x 5"



309-00011
Rubber Block 1.5"

RUBBER BLOCK 1.5"

- **RUBBER BLOCK DIMENSIONS:** 6" x 4"
- **Kit of four 1.5" rubber blocks**
- Spacer blocks for Rotary Airjacks and all Mid-Rise pad lifts

Ascot No.	Mfg. No.	Description
309-00011	JORB-1	Rubber Block 1.5"



309-00013
Rubber Block 3"

RUBBER BLOCK 3"

- **RUBBER BLOCK DIMENSIONS:** 6" x 4"
- **Kit of four 3" rubber blocks**
- Spacer blocks for Rotary Airjacks and all Mid-Rise pad lifts

Ascot No.	Mfg. No.	Description
309-00013	JORB-3	Rubber Block 3"

MISC. AUTO/FLEET SERVICE PRODUCTS



703-00509
Tire Dolly w/
Casters



TIRE DOLLY W/ CASTERS

- 300 lb. capacity
- Ideal for moving tires around or for tire storage
- **INCLUDES:** (4) swivel, non-marking and smooth 3" casters, (1) equipped with brake
- Unique built-in compartment stackable design for space saving storage
- **SIZE:** 25.2" x 25.2" x 4.33"



The Tire Dolly is ideal for moving tires around or for simply storing them.

Ascot No.	Mfg. No.	Description
703-00509	TC0509	Tire Dolly w/ Casters



703-00810
Tire Cart



TIRE CART

- Easy to maneuver, even with a full load of tires
- Can handle tires up to 35" in diameter
- Allows you to move tires 12" to 35" in size
- All you have to do is to push down on the pedal, slide the cart under the stack of tires and release the pedal - the frame lines up the tire on its own

Ascot No.	Mfg. No.	Description
703-00810	MTC	Tire Cart - 8 to 10 Tire Capacity, 35" Diameter Max
703-00812	MTC-GC	Gas Cylinder for MTC Tire Cart

703-00818
Tire Cart
Replacement
Tires/Wheels
Flat-Free



TIRE CART REPLACEMENT TIRES/WHEELS

- **Flat-free foam design**
- Industrial inner & outer wheel bearings
- **Sold as a pair of two**
- **SIZE: 10" x 3-1/2"**

Ascot No.	Mfg. No.	Description
703-00818	PU1005ASC	Tire Cart Replacement Tires/Wheels

MISC. AUTO/FLEET SERVICE PRODUCTS

322-19822
Dunk Tank for Passenger Cars



322-02444
Dunk Tank for SUV/Light Trucks



DUNK TANKS

- Heavy duty plastic tire and tube test tank
- Features pyramid type ribs for extra support to prevent bowing
- Handles passenger tire sizes to wide oval and light duty truck tires



Ascot No.	Mfg. No.	Description
322-19822	2400-10	Passenger Car
322-02444	2400-44	SUV/Light Truck

322-90045
Truck & Trailer Wheel Pan



5-LITER OIL DRAIN PAN FOR BUSES, TRAILERS & TRUCKS

- Catches oil from hubs after removing cap
- Fits rims on buses, trailers and large trucks
- Prevents oil mess during wheel repair
- Side opening design for easy dumping of oil collection
- Made of polypropylene for durability
- Capacity 5 liters (178 oz.)



Ascot No.	Mfg. No.	Description
322-90045	FS9004-5L	Truck & Trailer Wheel Pan

751-00072
72" Tire Display on Casters



72" TIRE DISPLAY ON CASTERS

- Provides an excellent compromise between strength and lightness
- Equipped with casters that let you move it quickly and easily
- Allows you to store 16 tires with an outside diameter of up to 31 inches



Ascot No.	Mfg. No.	Description
751-00072	MTD-72	72" Tire Display on Casters, 16-tire capacity

MISC. AUTO/FLEET SERVICE PRODUCTS

B'LASTER SILICONE LUBE

- Teflon™ fluoropolymer enhances performance
- Long-lasting lubrication
- Won't accumulate dust & dirt
- **QUANTITY:** 12 per case

Ascot No.	Mfg. No.	Description
328-00016	16-SL	B'laster Silicone Lube, 11 oz.



328-00016
B'laster Silicone Lubricant, 11 oz.

B'LASTER DRY LUBRICANT

- Teflon™ fluoropolymer helps reduce friction & wear
- Enhance performance
- Protect surfaces
- **QUANTITY:** 12 per case

Ascot No.	Mfg. No.	Description
328-00116	16-TDL	B'laster Dry Lubricant, 9.3 oz.

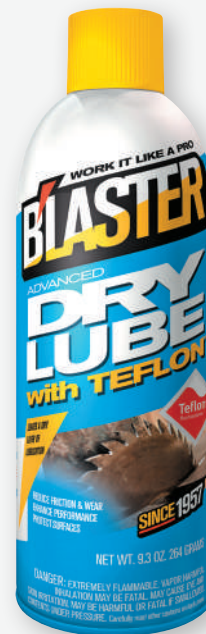

328-00116
B'laster Dry Lubricant, 9.3 oz.

MISC. AUTO/FLEET SERVICE PRODUCTS

FULL BORE HAND CLEANER

- Rids hands of dirt and grease while leaving the skin soft and chap free
- Solvent free
- Economical
- Contains skin moisturizers
- Clean fragrance
- Never irritates or burns open wounds
- Rinses clean
- Keeps your sink clean
- Keeps your pipes clean
- Will not separate during hot months
- Long shelf life
- Neutral pH
- Meets American Clean Waters Act



395-00103



395-00101



395-00102



395-00103



395-06402



395-00104



395-00125



395-00126

ASCOT NO.	MFG. NO.	DESCRIPTION
ULTRA FLOW		
395-00101	TS1GAL	Ultra Flow, 1 Gallon
395-00103	TS1Gal-W4P	Ultra Flow 1 Gallon w/ Pump
395-00102	TS1GAL-FT	Ultra Flow, 1 Gallon Flat Top
ULTRA FLOW DISPENSERS		
395-00104	Plastic Pump	Plastic Pump
395-00125	TS125-D	Stainless Steel Wall Mount Dispenser
395-00126	TS125-FT-D	Stainless Steel Wall Mount Dispenser (Fits Flat Top)
395-06402	EG-dispenser	Dispenser for Extreme Green 64 oz. Tub
SUPER GRIT		
395-40000	TS4000	Super Grit, 4 Gallon
395-06400	TS6400	Super Grit, 64 oz.
EXTREME GREEN		
395-00400	MG-HS-4GAL	Extreme Green, 4 Gallon
395-06401	MG-HS-64OZ	Extreme Green, 64 oz.



395-40000



395-00400



395-06400



395-06401

MISC. AUTO/FLEET SERVICE PRODUCTS

1/4" FPT RADIATOR FILLER

- Radiator faucet with heavy duty rubber nozzle
- 90° rubber spout
- Easy operation with lever control
- Spring-loaded lever-operated valve
- For water, anti-freeze, windshield washing fluid, etc.
- 1/4" FPT female inlet

Ascot No.	Mfg. No.	Description
329-18685	3281-RF	1/4" FPT Radiator Filler



329-18685
1/4" FPT Radiator Filler

8-IN-1 DRAIN PLUG WRENCH W/ MAGNET

- **Sizes: Hex 12, 13, 14, 15, 16, 17, 18, 19mm**
- 16 different socket sizes to fit most oil drain transfer case and differential plugs
- Heavy duty magnet on handle to hold drain plugs or nuts
- Offset head design

Ascot No.	Mfg. No.	Description
313-01219	ASC1219	8-in-1 Drain Plug Wrench w/ Magnet



313-01219
8-in-1 Drain Plug Wrench

LOCKING JAW PLIERS

- Curved jaw puts tremendous pressure on four points of any style nut or bolt head; includes convenient wire cutter
- Ideal for tightening, clamping, twisting and turning
- Turn screw to adjust pressure and fit work; stays adjusted for repetitive use
- Constructed of high-grade heat-treated alloy steel for maximum toughness and durability
- Guarded release trigger quickly unlocks and protects from accidental release

Ascot No.	Mfg. No.	Description
319-01023	AS102L3	10" Curved Jaw Locking Pliers
319-01024	AS102L3S	10" Straight Jaw Locking Pliers



319-01023
10" Curved Jaw Locking Pliers

319-01024
10" Straight Jaw Locking Pliers



8-PIECE PROFESSIONAL SCREWDRIVER SET

- Includes 5 flat tip and 3 Phillips tip drivers **SLOTTED:** 3/8" x 8", 5/16" x 6", 1/4" x 4", 3/16" x 3", 1/4" x 1-1/2"
- **PHILLIPS:** #2 Phillips x 4", #1 Phillips x 3", #2 Phillips x 1-1/2"
- **Hardened chrome vanadium shafts**
- **Hex bolsters for extra turning power**
- **Vapor blasted magnetic tips**
- Packaged in molded plastic tray for storage

Ascot No.	Mfg. No.	Description
319-19800	19800	8-Piece Professional Screwdriver Set



319-19800
8-Piece Professional Screwdriver Set





“It’s simple, really.

You have work to do, and customers to serve. Chicago Pneumatic is there to help you get the job done, without compromise.”

CP7782-6

- **1 Inch Air Impact Wrench**
- **6 Inch Extended Anvil**
- **Max Torque: 1,920 ft.lbs**
- **Speed: 5,200 RPM**
- **Pinless Closed Reinforced Rocking Dog Impact Mechanism**



**Chicago
Pneumatic**

People. Passion. Performance.

MISC. AUTO/FLEET SERVICE PRODUCTS

MILWAUKEE TOOL 28 OZ. DEAD BLOW HAMMER

- Provides maximum impact and the most durable handle
- Delivers the highest impact with minimal effort when swinging
- Steel reinforced handle core
- Durable handle is also resistant to peeling when exposed to solvents
- Precision balanced design, paired with the overmold handle and anti-slip grip offers more control
- Lifetime guarantee

Ascot No.	Mfg. No.	Description
426-29150	48-22-9150	Milwaukee Tool 28 Oz. Dead Blow Hammer

426-29150
Milwaukee Tool Dead Blow Hammer



NEW

GASKET SCRAPERS

- Removes pieces of old gasket, sealant and hardened oil or carbon deposits
- 1" wide forged alloy steel blade with chisel edge
- Can be re-sharpened
- Rugged molded plastic handle and steel shank
- 9-3/4" & 12" overall lengths available

Ascot No.	Mfg. No.	Description
319-02080	AS2080	Gasket Scraper - Overall Length - 9-3/4"
319-02081	AS2081	Long Gasket Scraper - Overall Length - 12"

319-02080
Gasket Scraper 9-3/4"

319-02081
Gasket Scraper 12"



PROFESSIONAL 4 PC. PRY BAR SET

- Chrome vanadium steel shafts
- Injection molded handle
- Black oxide finish resists corrosion
- Curved blades
- Includes 1/4" x 8", 3/8" x 12", 7/16" x 18" & 7/16" x 24" pry bars
- Includes handy storage tray

Ascot No.	Mfg. No.	Description
319-76403	AS-876404	Professional 4 Pc. Pry Bar Set

319-76403
Professional 4 Pc. Pry Bar Set

NEW



1/2" DRIVE 24" BREAKER BAR

- 24" breaker bar allows user to break free stubborn bolts or stuck fasteners
- 180° swivel head allows for multiple angles of use
- Heavy duty chrome vanadium steel construction
- Spring loaded ball bearing retains sockets
- Smoothly contoured, knurled handle for a comfortable grip
- Similar to SK Tools 41654
- Made in Taiwan

Ascot No.	Mfg. No.	Description
168-01224	NS-F4243RD	1/2" Drive 24" Breaker Bar

168-01224
1/2" Drive 24" Breaker Bar

COMING SOON!
FALL 2024



UNIVERSAL CHROME WRENCH EXTENDER

- Works with almost any wrench to increase leverage or gain access to hard-to-reach fasteners
- Handle offers comfort and control
- Polished, chrome plated CR-V steel
- Overall length: 15"
- Made in Taiwan

Ascot No.	Mfg. No.	Description
313-00385	NS-WE385	Universal Chrome Wrench Extender

313-00385
Universal Chrome Wrench Extender

COMING SOON!
FALL 2024



WRENCHES & TOOLS



11 PC. SAE LONG COMBINATION OPEN END WRENCH SET

- Open-end grip provides 25% more torque
- Offset box end
- Comfortable I-beam handle design
- Chrome plated for rust protection
- Convenient storage pouch
- Fractional sizes: 1/4", 5/16", 11/32", 3/8", 7/16", 1/2", 9/16", 5/8", 11/16", 3/4", 7/8"
- **Similar to Milwaukee 48-22-9411**

Ascot No.	Mfg. No.	Description
313-09411	AS9411	11 Pc. SAE Long Combination Open End Wrench Set



11 PC. METRIC LONG COMBINATION OPEN END WRENCH SET

- Open-end grip provides 25% more torque
- Offset box end
- Comfortable I-beam handle design
- Chrome plated for rust protection
- Convenient storage pouch
- Metric sizes: 8mm, 10mm, 11mm, 12mm, 13mm, 14mm, 15mm, 16mm, 17mm, 18mm, 19mm
- **Similar to Milwaukee 48-22-9415**

Ascot No.	Mfg. No.	Description
313-09511	AS9511	11 Pc. Metric Long Combination Open End Wrench Set



15 PC. SAE LONG COMBINATION OPEN END WRENCH SET

- Open-end grip provides 25% more torque
- Offset box end
- Comfortable I-beam handle design
- Chrome plated for rust protection
- Convenient storage pouch
- Fractional sizes: 1/4", 9/32", 5/16", 7/8", 11/32", 3/8", 7/16", 1/2", 9/16", 5/8", 11/16", 3/4", 13/16", 15/16", 1"
- **Similar to Milwaukee 48-22-9511**

Ascot No.	Mfg. No.	Description
313-09415	AS9415	15 Pc. SAE Long Combination Open End Wrench Set



15 PC. METRIC LONG COMBINATION OPEN END WRENCH SET

- Open-end grip provides 25% more torque
- Offset box end
- Comfortable I-beam handle design
- Chrome plated for rust protection
- Convenient storage pouch
- Metric sizes: 8mm, 9mm, 10mm, 11mm, 12mm, 13mm, 14mm, 15mm, 16mm, 17mm, 18mm, 19mm, 20mm, 21mm, 22mm
- **Similar to Milwaukee 48-22-9515**

Ascot No.	Mfg. No.	Description
313-09515	AS9515	15 Pc. Metric Long Combination Open End Wrench Set

MECHANIC'S GLOVES

RPG NITRILE MICRO-DIAMOND GLOVES

- Textured finish
- For industrial and automotive applications
- Powder-free
- THICKNESS: 6 mil Not made from natural rubber latex
- QUANTITY: 100 per box, 10 boxes per case



Ascot No.	Mfg. No.	Description
396-00301	32806BK240R2	Micro Diamond Black Nitrile Glove (Small)
396-00303	32806BK240R4	Micro Diamond Black Nitrile Glove (Large)
396-00304	32806BK240R5	Micro Diamond Black Nitrile Glove (XL)
396-00401	32806OR240R2	Micro Diamond Orange Nitrile Glove (Small)
396-00402	32806OR240R3	Micro Diamond Orange Nitrile Glove (Medium)
396-00403	32806OR240R4	Micro Diamond Orange Nitrile Glove (Large)
396-00404	32806OR240R5	Micro Diamond Orange Nitrile Glove (XL)



NITRILE GLOVES

- Powder-free disposable nitrile gloves
- 4.5 mil
- Suitable for automotive and industrial applications
- QUANTITY: 100 per box, 10 boxes per case

Ascot No.	Mfg. No.	Description
396-00803	BLK-L	Black Nitrile Gloves (L)
396-00804	BLK-XL	Black Nitrile Gloves (XL)
396-00805	BLK-XXL	Black Nitrile Gloves (XXL)



ASCOT BLACK POLYESTER WORK GLOVES

- Palm coated with nitrile offers good protection from liquids, oil & grease
- Excellent dexterity
- Ergonomic design for a comfortable fit
- 13-gauge polyester liner provides outstanding fit, feel & comfort to reduce hand fatigue
- Machine washable
- 12 per bag



Ascot No.	Mfg. No.	Description
396-50317	N/A	Black Polyester Work Gloves (Textured Palm)
396-50318	N/A	Black Polyester Work Gloves (Smooth Palm)
396-50319	N/A	Black Polyester Work Gloves (Smooth Palm Medium/Large)
396-50320	N/A	Black Polyester Work Gloves (Textured Palm Medium/Large)



MECHANIC'S GLOVES



396-95055



AME MAG-BEAR 25' MAGNETIC RETRACTABLE BARRIER

- Enhanced Safety: Our 25ft Belt with printed "Caution - Do Not Enter" Warning, in a vibrant yellow color, ensures the utmost safety by effectively restricting access to hazardous areas
- Durable Protection: The sturdy ABS protective case, featuring a striking black and yellow design, provides long-lasting protection for your equipment
- Ultimate Portability: Designed with portability in mind, this system can be easily moved and set up wherever needed, making it an indispensable tool for technicians on the go
- Technician Safety First: Prioritizing technician safety, our system helps safeguard them while servicing equipment, preventing unauthorized access and potential accidents
- Effortless Installation: With a magnetic mounting system, this product can be quickly and securely installed, saving you valuable time and effort
- Magnetic Strength: Equipped with six super strong magnets on the back and two on the belt end, this system boasts an exceptional magnetic force, ensuring it stays securely in place
- Reliable Security: Count on our super-strong magnets to maintain a dependable and robust barrier, effectively preventing unauthorized access and enhancing overall security

Ascot No.	Mfg. No.	Description
396-95055	95055	Mag-Bear 25' Magnetic Retractable Barrier

396-55220



396-10011

RPG MECHANIC'S GLOVES

- Black synthetic leather palm with small patches
- Features blue spandex on back, neoprene on knuckle, 4cm wide elastic, hook & loop

Ascot No.	Description
396-10011	RPG Mechanic's Gloves

DOUBLE PALM LEATHER GLOVES

Ascot No.	Mfg. No.	Description
396-55220	7533	Double Palm Leather Gloves (12 Pairs per Pkg.)



396-00901

SAFETY GLASSES-CLEAR LENS

- 12 pcs. per inner box
- 300 pcs. per case
- Clear lens
- Anti-scratch & anti-fog coating
- Lightweight, unisex protective eyewear
- High wraparound coverage
- Comfortable, contoured fit
- Designed for indoor or outdoor use
- Polycarbonate lenses absorb 99.9% UVA and UVB
- ANSI Z87.1 CE EN 166

Ascot No.	Mfg. No.	Description
396-00901	SG-2 CLEAR	Safety Glasses-Clear Lens



396-00902

SAFETY GLASSES-SMOKE LENS

- 12 pcs. per inner box
- 300 pcs. per case
- Smoke lens
- Anti-scratch & anti-fog coating
- Lightweight, unisex protective eyewear
- High wraparound coverage
- Comfortable, contoured fit
- Designed for indoor or outdoor use
- Polycarbonate lenses absorb 99.9% UVA and UVB
- ANSI Z87.1 CE EN 166

Ascot No.	Mfg. No.	Description
396-00902	SG-2 SMOKE	Safety Glasses-Smoke Lens

www.ascotsupply.com

⚠ WARNING: For more information go to www.P65Warnings.ca.gov.

TIRE REPAIR TOOLS & ACCESSORIES



**COB RECHARGEABLE WORK LIGHT
W/ USB CABLE**

- 400LM brightness
- Dimming Switch
- Features a hook on lamp head and base with magnet for hands-free operation
- WORKING TIME: Approx. 2.5 hrs.
- CHARGING TIME: Approx. 4 hrs.
- 8W COB LED



Ascot No.	Mfg. No.	Description
312-03007	TWL3007E	COB Rechargeable Work Light w/ USB Cable



LED RECHARGEABLE PEN LIGHT

- Aluminum pen light with laser and UV light
- Top UV light, wavelength: 365NM
- Side 5W COB Floodlight: 450 lumen
- Tail light: 3W spotlight white LED 140 lumen & red laser light
- Power Source: rechargeable Li-ion battery
- Includes: 50 cm USB-C cable
- Charging time: 3 hours
- Run time: COB 2.5 h, white spotlight: 2.5 hours
- 120° rotating metal clip with strong magnet
- Dimming switch with battery indication



Ascot No.	Mfg. No.	Description
312-07179	CP-R179	LED Rechargeable Pen Light

LED RECHARGEABLE HEADLIGHT

- Material: :ABS+Silicone
- LED: COB +3W led
- Battery:1200mAh Li-poly Battery(can be replaced)
- Function: COB high-COB low-3W led high-3W led low-COB flashing
- Press sensor switch, sensing function.
- Brightness: COB:200 lumen, 3W led:120 lumen
- USB Type-C cable (Included)
- Charging time: 3-4hours
- Working time: 3-8hours
- Waterproof & shockproof



Ascot No.	Mfg. No.	Description
312-39001	CP-H001	LED Rechargeable Head Light



312-07179
LED Rechargeable Pen Light



TIRE REPAIR TOOLS & ACCESSORIES



XLIGHT TIRE SERVICE LED WORK LIGHT

- **CONVENIENT:** Designed for hands-free lighting during tire service and other work applications
- 14" adjustable spring-tube for optimum light positioning within tight spaces
- **BRIGHTNESS:** 2-stage compact high-power LED light provides 125 & 250 lumen output
- Multiple high-power magnets on the handle and light head grip strongly to most metal surfaces
- **RECHARGEABLE BATTERIES:** Lithium-ion rechargeable battery
- Redesigned handle allows for 25% larger clamping diameter compared with original XLIGHT 14-921
- **CLAMP-ON HANDLE:** Clamp-on handle quickly and easily "grips" over the bead of the tire
- *Compatible with all passenger, light truck and commercial truck tires*
- *Compatible with all tire spreaders*

Ascot No.	Mfg. No.	Description
312-14923	14-923	XLight Tire Service LED Work Light



LED WORK LIGHT ASSEMBLY

- **LED worklamp for tire spreaders**
- Directional spotlight for increased visibility
- 8W COB LED will provide 650 Lumens, 750 Lux at 1M
- Stays cool to the touch
- Adjustable, flexible gooseneck
- Includes mounting bracket

Ascot No.	Mfg. No.	Description
312-08473	TR8473	LED Work Light Assembly

TIRE REPAIR TOOLS & ACCESSORIES

HAWK BILL TIRE REPAIR KNIFE

- High carbon steel, hawk bill notch, glaze finish, round burnt finish handle (riveted)

Ascot No.	Mfg. No.	Description
531-60570	X751N	2" Hawk Bill Notch Repair Knife

531-60570
Hawk Bill Tire Repair Knife



ROUND POINT FLEXIBLE REPAIR KNIFE

- High carbon steel, round point skiver, glaze finish, round burnt finish handle (riveted)

Ascot No.	Mfg. No.	Description
531-75150	X2RF	4" Round Point Flexible Tire Repair Knife

531-75150
Round Point Flexible Repair Knife



TAPER POINT FLEXIBLE REPAIR KNIFE

- High carbon steel, taper point, glaze finish, round burnt finish handle (riveted)

Ascot No.	Mfg. No.	Description
531-75190	X2T	4" Taper Point Flexible Tire Repair Knife

531-75190
Taper Point Flexible Repair Knife



OTHER KNIVES

Ascot No.	Mfg. No.	Description
531-60300	60300	4" x 1" Curved Notch Repair Knife
531-75220	75220	3/8" Curved Point Shoe Knife
531-75310	X3N	4-7/8" Round Point Skiving Knife

RAZOR BLADE SCRAPER W/ OFFSET HEAD

- Strong, solid handle ideal for stripping paint, caulk, labels, overspray, gasket material, urethane and glue
- No sharpening needed, just replace the blade
- Protective cover keeps blade sharp and prevents cuts
- Includes one standard single edge blade

Ascot No.	Mfg. No.	Description
537-05246	AS-5246	Razor Blade Scraper W/ Offset Head

537-05246
Razor Blade Scraper w/ Offset Head



ASCOT RAZOR BLADES

- 100 blades per box
- Great for paint prep, glass scraping and cutting rubber
- Fits all window scrapers and box cutters
- Each blade is protected in wax paper
- High-grade long-lasting high carbon steel edge

Ascot No.	Mfg. No.	Description
537-72967	RB-100	Ascot Razor Blades

537-72967
Razor Blades



TIRE REPAIR TOOLS & ACCESSORIES



505-71216
Aerosol
Pre-Buff
Cleaner



532-07460
Quart Cement
Can W/
Wooden
Handled
Brush

AEROSOL PRE-BUFF CLEANER

- Non-flammable
- Prepares rubber for easy tire repairs
- Removes contaminants
- Dries fast & leaves no residue
- 14 oz. per can
- **QUANTITY:** 12 cans per case

Ascot No.	Mfg. No.	Description
505-71216	N/A	Aerosol Pre-Buff Cleaner - Non-Flammable



532-74601
Wooden
Handled Brush



532-74602
Aluminum
Quart
Cement
Can

QUART CEMENT CAN W/ WOODEN HANDLED BRUSH

- Can capacity: 1 qt
- Air-tight design keeps cement clean and usable
- Brush-in-cap design prevents evaporation and contamination
- Similar to Rema 6020

Ascot No.	Mfg. No.	Description
532-07460	7460	Quart Cement Can W/ Wooden Handled Brush
532-74601	74601	Wooden Handled Brush For Quart Cement Can
532-74602	74602	Aluminum Quart Cement Can



532-14381
Quart Cement
Dispenser with
Plastic Handle
Brush



Plastic
Handle
Brush

QUART CEMENT DISPENSER WITH PLASTIC HANDLE BRUSH

- Refillable can designed for tire repair cements
- Screw-on brush-top to prevent leakage
- Large horsehair brush to carry more cement to the repair zone
- Stout, long-lasting varnished can for heavy duty handling
- Easy to clean
- Allows users to use their cements from a bulk source

Ascot No.	Mfg. No.	Description
532-14381	14-381	Quart Cement Dispenser with Plastic Handle Brush

CARBIDE CUTTING TOOLS

- Made In USA

Ascot No.	Mfg. No.	Description
533-00003	CB3	1/8" (3mm) Pointed End
533-00010	CB10	3/8"(10mm) Pointed End
533-00012	CB12	1/2" (12mm) Pointed End
533-00045	CB4.5	1/8" (4.5mm) Pointed End
533-01120	BU12B	1/2" Ball Burr
533-01140	BU14R	1/4" Router Burr (3" Overall Length)
533-01141	BU14T	1/4" Taper Burr
533-01180	BU18R	1/8" Router Burr
533-01181	BU18T	1/8" Taper Burr
533-01182	BU18TL	1/8" Taper Burr (3" Overall Length)
533-01316	BU316N	3/16" Taper Burr
533-01381	BU38T	3/8" Taper Burr
533-01516	BU516NR	5/16" Long Taper Burr
533-01716	BU716N	7/16" Long Taper Burr
533-01732	BU732N	7/32" Long Taper Burr



533-01120



533-01141



533-01181



533-01180



533-01381

TIRE REPAIR TOOLS & ACCESSORIES

BUFFING STONES FOR STEEL - BELTED TIRES

- Please specify white or brown color when ordering

Ascot No.	Mfg. No.	Description
534-80005	A-5	Small Cone 3/4" Stone Diameter
534-80001	A-1	Large Cone 3/4" Stone Diameter
534-80011	A-1B	Large Cone 3/4" Stone Diameter (Brown)
534-80015	A-15	Pencil Point 1/4" Stone Diameter
534-80057	'57	Carborundum Stone - 14"
534-80115	A-15B	Pencil Point 1/4" Stone Diameter (Brown)
534-80036	A-36	Stone Disc 1-3/4" Diameter
534-80136	A-36B	Stone Disc 1-3/4" Diameter (Brown)
534-80037	A-37	Stone Disc 1-1/4" Diameter
534-80137	A-37B	Stone Disc 1-1/4" Diameter (Brown)



SERIAL NUMBER REMOVAL TOOL

Ascot No.	Mfg. No.	Description
531-95001	TTHB-1	Serial Number Remover Tool
531-95002	RRB-1	12-Pack Replacement Blades



PROFESSIONAL STITCHERS

- Corrugated ball bearing stitcher with hardened steel wheel and varnished wooden handle

Ascot No.	Mfg. No.	Description
536-00001	CS-1	1-1/2" x 1/16" Corrugated Stitcher
536-02040	MRO2040	2" x 2" Flat Roller
536-02890	MRO2890	2" x 1/16" Corrugated Stitcher
536-02910	MRO2910	2" x 1/4" Corrugated Stitcher
536-06500	MRO6500	2" x 2" Porcupine Roller



ECONOMY BALL-BEARING STITCHERS



- **WHEEL DIAMETER:** 1-1/2"
- **HANDLE LENGTH:** 5"
- Serrated wheel
- **OVERALL LENGTH:** 7-1/2"
- Varnished wood handle

Ascot No.	Mfg. No.	Description
536-01121	VT-1121A	Economy Ball-Bearing Stitcher - 1.5" x 1/16"
536-01122	VT-1121B	Economy Ball-Bearing Stitcher - 1.5" x 1/8"

536-00001 1-1/2" x 1/16" Corrugated Stitcher 536-02040 2" x 2" Flat Roller 536-06500 2" x 2" Porcupine Roller

GOOSENECK STITCHER

- Ideal repair tool for trucks, cars and motorcycles
- Durable and ergonomic handle

Ascot No.	Mfg. No.	Description
536-00101	NS-TS01	Gooseneck Stitcher - 1.5" x 1/8"



TIRE REPAIR TOOLS & ACCESSORIES



537-00083
Color Coded Tire Injury Measuring Tool

NEW

537-00001
Black Handle Tire Probe Awl

537-00353
Black Handled Tire Denailer



537-00004
Black Handle Inner Liner Scraper



736-10004
Tire Repair Tool Pouch



537-00003
RPG Air Powered Tire Repair Vacuum

COLOR CODED TIRE INJURY MEASURING TOOL

- Color-coded injury measuring tool made of the highest quality materials and designed to make tire repair jobs easier and faster
- Measures the size of the injury allowing for proper sized tire repairs
- Heavy duty screwdriver-type handle
- Made in Taiwan
- Similar to Tech TRT105
- **Made in China**

Ascot No.	Mfg. No.	Description
537-00083	PHT-083A	Color Coded Tire Injury Measuring Tool

TIRE PROBE AWL

- Used to inspect injuries in tires and to remove small stones and debris

Ascot No.	Mfg. No.	Description
537-00001	AWL-1	Black Handle Awl

BLACK HANDLED TIRE DENAILER

- Recessed tip to allow nails or other puncturing objects to be pushed back through the tire
- **MADE IN THE USA**

Ascot No.	Mfg. No.	Blade Length	Recess Depth	Point Diameter	Overall Length
537-00353	353	7"	1/8"	5/16"	6-1/2"

INNER LINER SCRAPER

- This tool is a must for professional tire repairs
- Eliminates power buffing on many tire repairs
- Scraper removes material that might contaminate buffing wheels, ensuring a better repair every time

Ascot No.	Mfg. No.	Description
537-00004	S-4	Black Handle Inner Liner Scraper

TIRE REPAIR TOOL POUCH

- Durable nylon pouch
- 3-color tread depth gauge
- 5-50 psi pencil gauge
- Valve core tool
- White crayon
- Ink pen

Ascot No.	Mfg. No.	Description
736-10004	TTP	Tire Repair Tool Pouch

RPG AIR POWERED TIRE REPAIR VACUUM



- Quick change from blow to vacuum function
- Kit includes: Plastic body gun, dust bag, 2 extension tubes, shop brush, flat tube, tiny tube



Ascot No.	Mfg. No.	Description
537-00003	VBG2	RPG Air Powered Tire Repair Vacuum

TIRE REPAIR TOOLS & ACCESSORIES

FLARED CONTOUR/PRECISION CONTOUR WHEELS

- Redesigned to most effectively use their "SSG" tooth armorings
- Working faces of the wheels are at an angle to the shaft, which makes it easy to clear the hand-piece for working inside and outside of casings
- Wide and nearly flat working face radius produces the ideal texture over a wider contact area for a more even textured surface

Ascot No.	Mfg. No.	Description
538-10200	RH102	1-3/4" Flared Cup - 230 SSG
538-10700	RH107	2-1/2" Flared Cup x 1" x 3/8" w/ 170 SSG
538-10900	RH109	2-1/2" Flared Cup x 1" x 3/8" w/ 230 SSG
538-11100	RH111	2-1/2" Flared Cup x 1" x 3/8" w/ 390 SSG
538-11200	RH112	3" Flared Cup x 1-1/4" x 3/8" w/ 170 SSG
538-11400	RH114	3" Flared Cup x 1-1/4" x 3/8" w/ 230 SSG
538-11600	RH116	3" Flared Cup x 1-1/4" x 3/8" w/ 390 SSG
538-11800	RH118	3-1/2" Contour Wheel x 3/8" w/ 170 SSG
538-12000	RH120	3-1/2" Contour Wheel x 3/8" w/ 230 SSG
538-12200	RH122	3-1/2" Contour Wheel x 3/8" w/ 390 SSG
538-12900	RH129	4" Cup x 1-1/2" x 3/4" w/ 390 SSG
538-14000	RH140	1/4" x 3/8-24 Mini Patch Prep Wheel w/ 170 SSG



"MINI-CUP" FLARED CONTOUR WHEELS

- Innerliner buffer
- Available in grit or "SSG" coating

Ascot No.	Mfg. No.	Description
538-13000	RH130	2" Black Mini Cup w/ #60 Grit
538-13017	RH130-170	2" Mini Cup x 3/4" x 3/8" w/ 170 SSG
538-13023	RH130-230	2" Mini Cup x 3/4" x 3/8" w/ 230 SSG

538-13000
"Mini-Cup"
Flared
Contour
Wheel



POLYPLUGS FOR FLARED CONTOUR WHEELS

- Made for flared contour wheels and are reusable
- Make the wheels run true, protect them from damage and provide a flywheel effect for better control

Ascot No.	Mfg. No.	Description
538-15100	RH151	Polyplug Insert 3/8" ID for 2" Cup"
538-15200	RH152	Polyplug Insert 3/8" ID for 2-1/2" Cup
538-15400	RH154	Polyplug Insert 3/8" ID for 3" Cup

538-15200
Polyplug
for Flared
Contour
Wheel



RETREADING SIDEWALL WHEELS

- Designed for shoulder and sidewall preparation
- Used on manual or automatic sidewall buffers
- Fast and effective removal of oxidized rubber
- Used with or without traditional wire brushes
- Excellent durability, reducing cost per buff
- Provides a uniform texture maximizing rubber-to-rubber bond

Ascot No.	Mfg. No.	Description
538-70800	RH708	6" x 1" x 1-1/2" Donut Wheel, coarse (SSG 390)



538-70800

3" EXTREME FLARED CONTOUR WHEEL

- Rapid repair removal
- Coarse texturizing
- Heavy buffing without heat or loading
- Extremely long wear-life
- Applications: Repair removal, section repair, Post-rasp texturing of low spots along edge of crown (skiving station), Clean-up of sidewall repairs (final inspection)

Ascot No.	Mfg. No.	Description
538-11601	RH116X	3" Extreme Flared Contour Wheel

538-11601
3" Extreme
Flared
Contour
Wheel



TIRE REPAIR TOOLS & ACCESSORIES

538-30400
Round Face
Buzzout Wheel



538-60100
1/2" x 1/4" Shank
Ball w/ 330 SSG



538-61100
Small Taper



538-61900
Rotor Saw



538-62600
Nail Hole Reamer

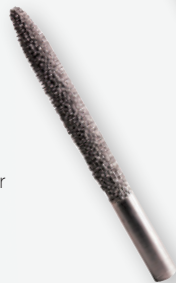

539-10001
Buffing Wheel



ROUND FACE BUZZOUT WHEELS

- **APPLICATIONS:** For skiving and texturing of larger exterior section repairs

Ascot No.	Mfg. No.	Description
538-30000	RH300	2" Buzzout x 1/4" x 3/8"-24b.o. w/ 230 SSG
538-30200	RH302	2" Buzzout x 1/4" x 3/8"-24b.o. w/ 390 SSG
538-30600	RH306	2" Buzzout x 3/8" x 3/8"-24b.o. w/ 390 SSG

SMALL AND MEDIUM BALLS

- Medium balls for skiving/ texturing of larger exterior section repairs
- Small balls for skiving/texturing of medium exterior section repairs

Ascot No.	Mfg. No.	Description
538-60100	RH601	1/2" x 1/4" Shank Ball w/ 330 SSG
538-60300	RH603	3/4" x 1/4" Shank Ball w/ 330 SSG

SMALL TAPERS

- **APPLICATIONS:** For small section repairs of tread and sidewall

Ascot No.	Mfg. No.	Description
538-61100	RH611	1/2" x 1/4" Shank Taper w/ 330 SSG

ROTOR SAWS

- **APPLICATIONS:** For small buzzout repairs of tread and sidewall

Ascot No.	Mfg. No.	Description
538-61900	RH619	1-3/8" x 1/8" x 1/4" Shank Saw w/ 330 SSG

NAIL HOLE REAMERS

- **APPLICATIONS:** For plug repairs on fabric tires only

Ascot No.	Mfg. No.	Description
538-62600	RH626	1/4" x 3" x 1/4" Shank NHR w/ 390 SSG & #23 Grit

BUFFING WHEEL

- **APPLICATIONS:** For use on tires or tubes
- Coarse grit, round nose
- Tungsten carbide
- 2-1/2" diameter

Ascot No.	Mfg. No.	Description
539-10001	BC-1	2-1/2" Radius Cup Rasp



7" DIAGONAL CUTTING PLIERS

- XTREME LEVERAGE TECHNOLOGY (XLT™) increases performance and reduces hand fatigue
- Laser treated cutting edges perform better and last longer
- Precision-machined knife and anvil style cutting edges ensure perfect mating for superior performance and longevity
- Forged high carbon U.S. steel for maximum strength and durability is specially coated for ultimate rust prevention
- Blue comfort grips
- **100% MADE IN USA**

Ascot No.	Mfg. No.	Description
319-00337	337	7" Diagonal Cutting Pliers



319-00337
7" Diagonal Cutting Pliers

7.75" CURVED DIAGONAL CUTTING PLIERS

- Curved diagonal for maximum pulling leverage
- Perfectly mated cutter, heat treated to hold its edge
- Polished high carbon drop forged steel
- Blue comfort grips

Ascot No.	Mfg. No.	Description
319-00447	447	7.75" Curved Diagonal Cutting Pliers



319-00447
7.75" Curved Diagonal Cutting Pliers

8" CUTTING PLIER WITH END CUTTER

- Perfectly mated cutter, scientifically heat treated to hold its edge
- Polished high carbon drop forged steel
- Blue comfort grips

Ascot No.	Mfg. No.	Description
319-00358	358	8" Cutting Plier with End Cutter



319-00358
8" Cutting Plier with End Cutter

TIRE REPAIR TOOLS & ACCESSORIES

319-01337
7" Diagonal
Cutting Pliers



7" DIAGONAL CUTTING PLIERS

- Laser treated cutting edges perform better and last longer
- Precision-machined knife and anvil style cutting edges ensure perfect mating for superior performance and longevity
- Forged high carbon steel for maximum strength and durability is specially coated for ultimate rust prevention
- comfort grips
- **MADE IN TAIWAN**

COMING SOON!
FALL 2024

Ascot No.	Mfg. No.	Description
319-01337	A337	7" Diagonal Cutting Pliers

319-01447
7.75" Curved
Diagonal
Cutting Pliers



7.75" CURVED DIAGONAL CUTTING PLIERS

- Curved diagonal for maximum pulling leverage
- Perfectly mated cutter, heat treated to hold its edge
- Polished high carbon drop forged steel
- comfort grips
- **MADE IN TAIWAN**

COMING SOON!
FALL 2024

Ascot No.	Mfg. No.	Description
319-01447	A447	7.75" Curved Diagonal Cutting Pliers

319-01358
8" Cutting Plier
with End Cutter



8" CUTTING PLIER WITH END CUTTER

- Perfectly mated cutter, scientifically heat treated to hold its edge
- Polished high carbon drop forged steel
- comfort grips
- **MADE IN TAIWAN**

COMING SOON!
FALL 2024

Ascot No.	Mfg. No.	Description
319-01358	A358	8" Cutting Plier with End Cutter

TIRE REPAIR TOOLS & ACCESSORIES

TIRE LABELS

- 2-1/2" x 6" label for easy identification of new, used and retreaded tires
- **QUANTITY:** Packed 500 per roll

Ascot No.	Mfg. No.	Description
601-00101	TL-101	Tire Labels New-Used-Retread

601-00101
Tire Labels



MISCELLANEOUS TIRE REPAIR TOOLS

Ascot No.	Mfg. No.	Description
537-90002	SEPG	Plastic Pistol Grip Handle - Short
537-90003	OETT	Plastic T-Handle
537-90006	TST	Chrome Plated T-Handle with 3" Replaceable Needle
537-90009	SPPG	Plastic Pistol Grip Handle Spiral Probe
537-90019	TSPRB	Chrome Plated T-Handle Spiral Probe
537-90035	WRN35	Replacement Needle: 3-1/2"

Ascot No.	Mfg. No.	Description
537-90045	WRN45	Replacement Needle: 4-1/2"
537-90116	TST	Metal T-Handle Insertion Tool
537-90119	PRBR	Replacement Spiral Probe
537-90135	AWRN35	Replacement Needle: 3-1/2"
537-90150	P150	Heavy Duty Screwdriver-Type Handle Barbed Rasp
537-90155	AWRN55	Replacement Needle: 5-1/2"

Ascot No.	Mfg. No.	Description
537-90200	TSBRP	Chrome Plated T-Handle with Barbed Rasp
537-90201	PPG	Plastic Pistol Grip Handle Barbed Rasp
537-92119	ATSPRB	Metal T-Handle Spiral Probe for Auto/Lt Truck

537-90002
Plastic Pistol Grip Handle - Short



537-90019
Chrome Plated T-Handle Spiral Probe



537-90009
Plastic Pistol Grip Handle Spiral Probe



537-90003
Plastic T-Handle



537-90150
Heavy Duty Screwdriver-Type Handle Barbed Rasp



537-90201
Plastic Pistol Grip Handle Barbed Rasp



537-90006
Chrome Plated T-Handle with 3" Replaceable Needle



537-90116
Metal T-Handle Insertion Tool



537-90119
Replacement Spiral Probe



537-90035
Replacement Needle (3-1/2")



537-92119
Metal T-Handle Spiral Probe for Auto/Lt Truck



537-90200
Chrome Plated T-Handle with Barbed Rasp



CEMENTS, SEALANTS & PATCHES

TIRE REPAIR CHEMICALS

- Fast drying
- Wide brush for easy application

Ascot No.	Mfg. No.	Description
501-90018	ASV8	Clear Chemical Vulcanizing Cement, 8 oz. (24 per case)
501-90032	ASV32	Clear Chemical Vulcanizing Cement, Quart (6 per case)
501-90008	ASV8BL	Blue Chemical Vulcanizing Cement, 8 oz. (24 per case)
504-90011	ABSG	Black Bead Sealer, Gallon (4 per case)
504-90032	ABS32	Black Bead Sealer, Quart (6 per case)
504-90005	ABS5G	Black Bead Sealer, 5-Gallon
504-90016	ARS16BK	Black Inner Liner Sealer, 16 oz. (12 per case)
505-90032	ABU32	Inner Liner Cleaner, Quart (12 per case)

504-90005
Black Bead Sealer, 5-Gallon



504-90011
Black Bead Sealer, Gallon



504-90032
Black Bead Sealer, Quart



501-90018
Clear Chemical Vulcanizing Cement, 8 oz.

501-90032
Clear Chemical Vulcanizing Cement, Quart



501-90008
Blue Chemical Vulcanizing Cement, 8 oz.



504-90016
Black Inner Liner Sealer, 16 oz.

CEMENTS, SEALANTS & PATCHES

PUSH THROUGH PATCH/PLUG

- One-piece molded rubber patch/plug unit with a metal quill that protects the stem from damage during insertion
- **APPLICATIONS:** For tread area of bias and radial passenger and truck tires

Ascot No.	Mfg. No.	Description
587-01150	QS50R	1/8" Quill Patch Plug (48 per Box)
587-01151	QSR1	1/4" Quill Patch Plug (24 per Box)
587-01152	QSR2	1/4" Quill Patch Plug (48 per Box)



587-01150
Push Through Patch/Plug

LEAD WIRE PULL THROUGH PATCH/PLUG

- Easiest and most popular method to fill a nail-hole and apply a patch in one simple step
- Lead-wire guides the rubber stem through injury
- Stem coated with self vulcanizing material and patch features Versacure bonding gum
- **APPLICATIONS:** For tread area of bias and radial passenger and truck tires

Ascot No.	Mfg. No.	Description
587-01303	M-3	1/8" Plug-N-Patch (48 per Box)
587-01306	M-6	1/4" Plug-N-Patch (24 per Box)
587-01309	M-9	3/8" Plug-N-Patch (24 per Box)



587-01303
Lead Wire Pull Through Patch/Plug



587-01309
Lead Wire Pull Through Patch/Plug



BLUE WRAP PATCH PLUGS

- Grey cushion gum
- Wrapped in blue poly
- **QUANTITY:** 24 per box, 63 boxes per case

Ascot No.	Mfg. No.	Description
587-01406	M6B	1/4" Plug-N-Patch: Grey Cushion Gum, Blue Wrap (24 per Box, 63 Boxes per Case)
587-01409	M9B	3/8" Plug-N-Patch: Grey Cushion Gum, Blue Wrap (24 per Box, 63 Boxes per Case)



587-01406
M6B Patch/Plug



587-01409
M9B Patch/Plug

WIRE PULLER

Ascot No.	Mfg. No.	Description
468-01120	VT-1120L	7-1/4" Wire Puller



468-01120
Wire Puller

CEMENTS, SEALANTS & PATCHES



541-90020
Large Round Tube Repair



541-90030
Medium Round Tube Repair



541-90040
Small Round Tube Repair



550-90000
Small Round Universal Radial/Bias Repair



550-90004
Medium Round Universal Radial/Bias Repair



550-90005
Large Round Universal Radial/Bias Repair



550-90001
Small Square Universal Radial/Bias Repair, Grey Gum/Red Plastic



550-90011
Small Square Universal Radial/Bias Repair, Grey Gum/Red Plastic



550-90017
Small Square Universal Radial/Bias Repair, Black Gum/Blue Plastic

TUBE REPAIRS

- Feather edge, soft gum repairs
- For use with all types of tubes
- *Repair using chemical vulcanizing cement*

Ascot No.	Mfg. No.	Description
541-90020	ARB20	Large Round Tube Repair: 3-1/8" (20 per box)
541-90030	ARB30	Medium Round Tube Repair: 2-1/8" (30 per box)
541-90040	ARB40	Small Round Tube Repair: 1-9/16" (40 per box)
541-90101	ARB100-1000	Small Round Tube Repair: 1-9/16" (1000 per box)

UNIVERSAL RADIAL/BIAS REPAIRS

- For use on private passenger and light truck tires up to 1/4" injuries
- Rubber reinforced soft gum
- *Repair using chemical vulcanizing cement*

Ascot No.	Mfg. No.	Description
550-90000	AWR0	Small Round Universal Radial/Bias Repair: 1-9/16" (35 per box)
550-90002	ASQ2	Medium Square Universal Radial/Bias Repair: 2-1/8", Grey Gum/Red Plastic (40 per box)
550-90004	AWR4	Medium Round Universal Radial/Bias Repair: 2-1/8" (30 per box)
550-90005	AWR5	Large Round Universal Radial/Bias Repair: 3-1/8" (18 per box)
550-90008	AWR8	Medium Square Universal Radial/Bias Repair: 2-1/4" (25 per box)
550-90009	AWR9	Large Square Universal Radial/Bias Repair: 2-3/4" (15 per box)
550-90011	ASQ1T	Small Square Universal Radial/Bias Repair: 1-3/4", Grey Gum/Red Plastic (100 per tub)
550-90012	ASQ2T	Medium Square Universal Radial/Bias Repair: 2-1/8", Grey Gum/Red Plastic (80 per tub)
550-90014	AWR4T	Medium Round Universal Radial/Bias Repair: 2-1/8" (100 per tub)
550-90015	AWR5T	Large Round Universal Radial/Bias Repair: 3-1/8" (50 per tub)
550-90017	AWR7T	Small Square Universal Radial/Bias Repair: 1-3/4", Black Gum/Blue Plastic (100 per tub)
550-90018	AWR8T	Medium Square Universal Radial/Bias Repair: 2-1/4", Black Gum/Blue Plastic (50 per tub)
550-90019	AWR9T	Large Square Universal Radial/Bias Repair: 2-3/4", Black Gum/Blue Plastic (50 per tub)
550-90031	ASQ3T	Large Square Universal Radial/Bias Repair: 2-1/4", Grey Gum/Red Plastic (50 per tub)
550-90114	AWR4-1000	Medium Round Universal Radial/Bias Repair: 2-1/8" (1000 per box)
550-90200	AWR0T	Small Round Universal Radial/Bias Repair: 1-9/16" (200 per tub)
550-90550	AWR5-500	Large Round Universal Radial/Bias Repair: 3-1/8" (500 per box)
550-91000	AWR0-1000	Small Round Universal Radial/Bias Repair: 1-9/16" (1000 per box)
550-92100	ASQ2-1000	Medium Square Universal Radial/Bias Repair: 2-1/8", Grey Gum/Red Plastic (1000 per box)

CEMENTS, SEALANTS & PATCHES



BIAS HEAVY DUTY UNITS

- ASB series is a cord reinforced soft gum repair
- ACB series is a cord reinforced repair with hard blue gum
- *Repair with chemical vulcanizing cement*

Ascot No.	Mfg. No.	Description
564-90012	ASB2	Bias Heavy Duty: 2-7/8" (20 per box)
564-90013	ASB3	Bias Heavy Duty: 4-5/8" (10 per box)
564-90014	ASB4	Bias Heavy Duty: 5-3/8" (10 per box)
564-90022	ACB2HD	Bias Heavy Duty: 2-7/8" (20 per box)
564-90111	ACB1HD	Bias Heavy Duty: 2-1/2" (20 per box)



564-90111
Bias Heavy Duty
(2-1/2")



564-90012
Bias Heavy Duty
Unit (2-7/8")

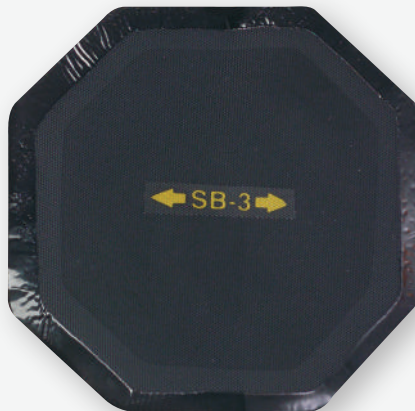

564-90013
Bias Heavy Duty
Unit (4-5/8")



564-90014
Bias Heavy Duty
Unit (5-3/8")

CEMENTS, SEALANTS & PATCHES



576-90010
Radial Heavy Duty Truck Unit (2-1/8" x 3")



576-90110
Radial Heavy Duty Truck Unit (2-1/8" x 3")

RADIAL HEAVY DUTY TRUCK UNITS

- ACX series is a cord reinforced hard blue gum repair (*For radial repairs only*)
- ASX series is a cord reinforced soft gum repair (*For radial tires only*)

Ascot No.	Mfg. No.	Description
576-90010	ACX10	Radial Heavy Duty: 2-1/8" x 3" (20 per box)
576-90012	ACX12	Radial Heavy Duty: 2-3/4" x 4-1/2" (10 per box)
576-90014	ACX14	Radial Heavy Duty: 3-3/8" x 5-1/8" (10 per box)
576-90020	ACX20	Radial Heavy Duty: 3-1/8" x 4-7/8" (10 per box)
576-90040	ACX40	Radial Heavy Duty: 3-7/8" x 7-5/8" (10 per box)
576-90110	ASX10	Radial Heavy Duty: 2-1/8" x 3" (20 per box)
576-90111	ASX10-300	Radial Heavy Duty: 2-1/8" x 3" (300 per box)
576-90112	ASX12	Radial Heavy Duty: 2-3/4" x 4-1/2" (10 per box)
576-90114	ASX14	Radial Heavy Duty: 3-3/8" x 5-1/8" (10 per box)
576-90120	ASX20	Radial Heavy Duty: 3-1/8" x 4-7/8" (10 per box)



571-90410
4" Orange, 12 Strand Tire Repair

571-90705
7" Black, 5 Strand Tire Repair

STRAND TIRE REPAIR

- Excellent emergency repair when a full service repair facility is unavailable
- Produced using butyl rubber and 100% saturated cord
- Excellent for golf carts, lawn mowers and ATV's
- **MADE IN THE USA**
- **QUANTITY:** 10 packets per box

Ascot No.	Mfg. No.	Description
571-90410	VRI410	4" Orange, 12 Strand Tire Repair (10 Packets per Box)
571-90705	VRI705	7" Black, 5 Strand Tire Repair (10 Packets per Box)

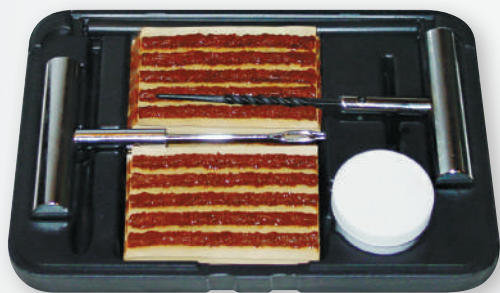

518-90060
Tubeless Tire Insert Kit

TUBELESS TIRE INSERT KIT

- For use on the wheel
- Designed for emergency repairs
- Fast and easy application
- Made in the USA by Western States/Elgi

TUBELESS TIRE INSERT KIT CONTAINS:

- 1 HD chrome T-Handle slot eye inserter w/ replaceable needle
- 60 brown string inserts
- 1 HD chrome T-Handle spiral probe w/ replaceable probe
- 1 plug lubricant
- 1 razor knife

Ascot No.	Mfg. No.	Description
518-90060	ATS60K	Tubeless Tire Insert Kit

CEMENTS, SEALANTS & PATCHES

HEAVY DUTY 4" AUTOMOTIVE REPAIR INSERT KIT

- For use on the wheel • Everything needed to make temporary, emergency repairs to most flat tires caused by nails or other objects up to 1/4" • 518-90130 KIT INCLUDES: (30) 4" temporary inserts, metal t-handle insertion tool, metal t-handle probe, lubricant, cutting blade, Allen wrench and instructions • 518-90160 KIT INCLUDES: (60) 4" temporary inserts, metal t-handle insertion tool, metal t-handle probe, lubricant, cutting blade, Allen wrench and instructions • Blow molded case for easy storage



518-90160

FOR EASY, TEMPORARY REPAIRS

TOP SELLER

Ascot No.	Mfg. No.	Description
518-90160	ATR60K-HD	Heavy Duty 4" Automotive Repair Insert Kit - 60 Repairs

*Product Case Color May Vary

HEAVY DUTY 8" AUTOMOTIVE REPAIR INSERT KIT

- For use on the wheel • Everything needed to make temporary, emergency repairs to most flat tires caused by nails or other objects up to 1/4" • KIT INCLUDES: (30) 8" temporary inserts, metal t-handle insertion tool, metal t-handle probe, lubricant, cutting blade, Allen wrench and instructions • Blow molded case for easy storage

*Product Case Color May Vary



518-90030

Ascot No.	Mfg. No.	Description
518-90030	ATS30K-HD	Heavy Duty 8" Automotive Repair Insert Kit - 30 Repairs

BROWN, 12 STRAND TIRE REPAIR INSERT W/ BLUE PAPER BACKING

- 8" brown • Made in the USA • Extended shelf life • No leaks • 3rd party testing • EPA approved • Durable cord body • 100% butyl saturation • 6 repairs per packet • 5 packets per box



571-91964



571-91968

Ascot No.	Mfg. No.	Description
571-91964	ATS1964	4" Brown, 12 Strand Tire Repair Insert w/ Blue Paper Backing
571-91968	ATS1968	8" Brown, 12 Strand Tire Repair Insert w/ Blue Paper Backing



Ascot Supply Corp. does not recommend "temporary" tire repairs. All repairs should perform the function of filling or replacing the injured section as recommended by the RMA and other industry associations.

TIRE REPAIR CABINETS



719-12001

HEAVY DUTY TIRE REPAIR CABINET

Features sliding storage drawers with rollers.

- SIZE: 19.6" x 10" x 26"
- 2 shelves inside (3 storage levels)
- 2 tool hook sets on two inside doors
- 2 sliding storage drawers with rollers
- Switch-to-open handle
- Optional shelf available
- WEIGHT: 36 lbs.



Ascot No.	Mfg. No.	Description
719-12001	TBG-WC12001	Heavy Duty Tire Repair Cabinet
719-12011	TBG-WC12001-01	Optional Shelf for Tire Repair Cabinet



719-00018

18-DRAWER METAL STORAGE CABINET

- CABINET SIZE: 33-3/4" (W) x 11-3/4" (D) x 10-3/4" (H)
- DRAWER SIZE: 4-7/8" (W) x 11-1/4" (D) x 2-3/4" (H)
- Modular drawer design for efficiency and organization
- Heavy-duty, welded steel construction provides strength and stability
- Drawers feature stoppers to prevent accidental pulling or spilling
- Full-width handles and easy glide runners
- Shipped fully assembled and ready to use
- WEIGHT: 45 lbs.



Ascot No.	Mfg. No.	Description
719-00018	18D	18-Drawer Metal Storage Cabinet



719-00032

32-BIN METAL STORAGE CABINET

- CABINET SIZE: 33-3/4" (W) x 8-1/2" (D) x 19-1/4" (H)
- BIN SIZE: 4" (W) x 8-3/8" (D) x 4-1/2" (H)
- Keeps your tools and accessories organized and accessible
- Heavy-duty, welded steel construction provides strength and stability
- Hemmed bin fronts for retaining parts
- Mounting holes located in the top and bottom
- Shipped fully assembled and ready to use
- WEIGHT: 37 lbs.

Ascot No.	Mfg. No.	Description
719-00032	32B	32-Bin Metal Storage Cabinet

*Actual product appearance may vary

TIRE SPREADERS

1750LB CAPACITY HEAVY DUTY WORK BENCH

- 1750 lb. capacity Heavy duty steel construction
- Equipped with easy-to-use leveling feet
- Bolts together for quick assembly
- Sliding storage drawer
- Blue powder coated finish
- Dimensions: 63" x 27" x 34", 124 Lbs



Ascot No.	Mfg. No.	Description
721-63001	TWB63001	1600 Lb. Capacity Heavy Duty Work Bench w/ Leveling Feet



721-63001
Heavy Duty Work Bench

ADJUSTABLE CENTER-POST TIRE SPREADER

- Easy to use, durable
- Adjustable from 0" to 10"

Ascot No.	Mfg. No.	Description
605-08028	N/A	Adjustable Tire Spreader 0" to 10"



605-08028
Adjustable Center-Post Tire Spreader

MANUAL TIRE SPREADER

- Lightweight and easy to use
- Special locking pin for safety
- Made from durable materials
- Locks both beads open for easy tire inspection and repair

Ascot No.	Mfg. No.	Description
605-14191	MS-1	Manual Tire Spreader



605-14191
Manual Tire Spreader

TIRE SPREADER

- Designed for quick spreading of tire beads
- Improves ease of tire repair by opening up inner tire
- Compatible with an impact gun or torque wrench
- Ideal for mobile service
- **DIMENSIONS:** 19" x 3" x 11"

Ascot No.	Mfg. No.	Description
605-00101	GTS-01	Tire Spreader



605-00101
Tire Spreader

TIRE SPREADERS



604-01275
Floor Mount
Adjustable Tire
Spreader

**FLOOR MOUNT ADJUSTABLE
TIRE SPREADER**

- Provides easy access for repairing passenger and light truck tires
- The adjustable tire spreader can accommodate all tires from garden service through light truck
- The Tire Spreader has a foot-control swivel, tilts, and is equipped with a tool tray and a floor stand base-plate



Ascot No.	Mfg. No.	Description
604-01275	BJ-275B	Floor Mount Adjustable Tire Spreader



603-00275
Air Operated
Tire Spreader

AIR OPERATED TIRE SPREADER

- For passenger/RV/light truck tires
- Wide platform gives stable work surface
- Adjustable light



Ascot No.	Mfg. No.	Description
603-00275	BJ-S275	Air Operated Tire Spreader

PARTS & ACCESSORIES

Ascot No.	Mfg. No.	Description
603-43700	437	Working Light for Air Operated Tire Spreader



603-00825
Automatic Truck
Tire Spreader

AUTOMATIC TRUCK TIRE SPREADER

- Air lift allows operator to lift without lifting the tire/wheel
- Heavy gauge steel construction
- *Work light included*
- *Air regulator/lubricator included*



Ascot No.	Mfg. No.	Description
603-00825	BJ-S825	Automatic Truck Tire Spreader

PARTS & ACCESSORIES

Ascot No.	Mfg. No.	Description
603-82502	650	Air Regulator for Automatic Truck Tire Spreader
603-82517	BJ-S825-17	Spreader Control Valve For Automatic Truck Spreader

TIRE CHANGERS

MANUAL TIRE CHANGER

- Applications: For changing small tires and wheels
- Includes: Everything needed to change 4" to 16.5" tires including rim
- Rim clamp mechanism
- 2 center posts (for open or hub type wheels and bearing type wheels)
- Can be mounted on a bench, tire stand, or tire changer



441-00220
Manual Tire Changer

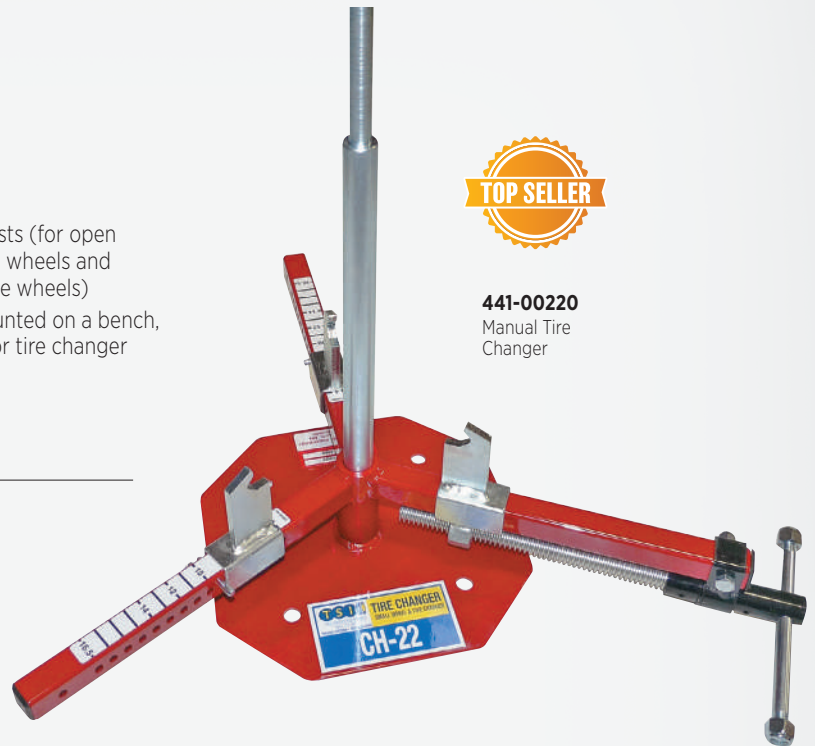

Ascot No.	Mfg. No.	Description
441-00220	CH-22	TSI Manual Tire Changer



MANUAL TIRE CHANGER

- Small tire changing system for lawn & garden, ATV and other small tires/wheels
- Not for passenger tires
- Adjustable to accommodate multiple tire/wheel sizes
- High quality, energy saving & environmentally friendly
- Portable and equipped with professional accessories
- Can be operated easily without the use of power or pneumatic supplies
- Works for an impressive range of tires
- Great for family and commercial garages, racing teams, emergencies and any time a convenient changer is required

441-00202
Manual Tire Changer



Ascot No.	Mfg. No.	Description
441-00202	BJ-CO2	Manual Tire Changer



AUTEL BT608 WIRELESS BATTERY AND SYSTEM ANALYZER

- **Battery life cycle management with intelligent battery diagnostics to reduce misdiagnosis, diagnose low capacity batteries and reduce charge & retest for discharged batteries**
- Largest vehicle coverage: 53 vehicle makes
- **5.5-inch touchscreen complete with graphic instruction for battery position and testing**
- Guided replacement procedure with prompted memory resets. Auto battery registration after replacement
- Built-in thermal printer to print health reports
- Includes Bluetooth VCI unit, clamp cables and thermal paper roll

Tool shown in use.

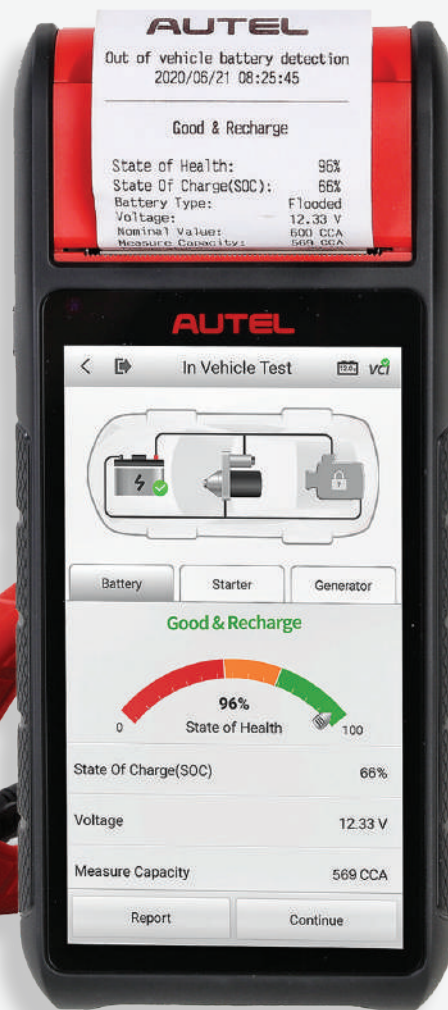

342-00608
Wireless Battery & System Analyzer



Ascot No.	Mfg. No.	Description
342-00608	BT608	Autel Wireless Battery and System Analyzer

ALPHABETICAL INDEX

// A

Air Chucks - Ball Foot	158
Air Chucks - Dual Foot	158
Air Chucks - European Style	158
Air Chucks - Large Bore	159
Air Chucks - Lock-On	158
Air Chucks - Lock-On Extension	159
Air Drill Parts & Accessories	32
Air Drills	32
Air Gauge	104
Air Hose Reels	16
Air Hoses - Coupled	16
Air Hoses - Hunter Replacement	105
Air Hoses - Coats Replacement	105
Air Hoses Blue Recoil	17
Air Line Inflators	157
Air Line Inflators - Large Bore	157
Air Tanks - Portable	17
Air Tool Lubricants	38
Air Wedge Bag Kit	88
Air/Hydraulic Pumps	96
Anti-Seize Compounds	147

// B

Balancing Beads - Counteract	168
Balancing Beads - Eco	169
Balancing Compound - Magnum+	170
Balancing Compound - Equal Flexx	170
Batteries - Lithium	36
Battery & System Analyzer	214
Bead Breakers	90,92,93
Bead Breaking Hammers	93
Bead Buster - Liquid	111
Bead Holders	89
Bead Keepers	89
Bead Lifting Tools	104
Bead Seaters - Bead Bazookas	101
Bead Seaters - Bead Bazooka Parts & Acc.	101
Bead Seaters - Cheetah	99
Bead Seaters - Cheetah Parts & Acc.	100
Bead Seaters - RPG	97,98
Bead Seaters - RPG Parts & Acc.	98
Bead Seaters - Viper	100
Blow Gun Kit	17
Bottle Jacks - 20-Ton	64,68
Bottle Jacks - 30-Ton	65
Bottle Jacks - Ascot	59
Bottle Jacks - Replacement Parts	59
Brake Rotor Securing Tool	73

// B (CONT.)

Brake Thickness Gauges	145
Breaker Bars	189
Brushes	106
Buffing Stones	197
Buffing Wheels	200
Buzzout Wheels	200

// C

Cabinets	47,210
Cabinets - Tire Changers	105
Calcium Chloride Pump	94
Carbide Cutting Tools	196
Cement Cans & Brushes	196
Centering Kits	179
Centering Sleeve Install/Removal	55
Centering Sleeves	55
Chemical Vulcanizing Cements	204
Chuck Adapters	37
Clamps - 2 Ear	21
Clamps - Pinch	21
Cleaner - Pre-Buffer	196
Cleaner Tool Kits	85
Collets	178,179
Contour Wheels	199
Couplers	18,19
Cut Off Tools	32
Cut Off Wheels	116
Cutters - High Speed	26

// D

Demount Tools	91
Die Grinders - Mini Angle	26,32
Drain Pans	184
Drop Center Tool	87
Dual Wheel Separator	96
Duckheads	103
Dunk Tanks	184

// E

Emergency Triangle Kit	75
Equal Flexx	170
Eraser Pads	31

// F

Filters/Regulators/Lubricators	14,15
Flange Plate Kit	179
Floor Dispenser Rack	79
Floor Jacks - 2-Ton	64

// F (CONT.)

Floor Jacks - 3.5-Ton	64
Floor Jacks - 4-Ton	66
Floor Jacks - Ascot	57,58
Floor Jacks - Replacement Parts	58
Floor Mats	76
Foam Kneeling Pad	78

// G

Gasket Scrapers	189
Gauge Checking Stations	153
Gauge Counter Displays	149
Gloves - Double Palm	192
Gloves - Mechanic	192
Gloves - Nitrile Micro Diamond	191
Gloves - Polyester Work	191
Grinding Discs - Green Zirconia	115
Grip-Max Inserts	103
Grommets - Replacement	129

// H

Hammers - Dead Blow	189
Hand Cleaners	186
Handle Protectors	89
Hose Barbs	20
Hub Cleaners - Hub Buddy Tool	85
Hub Cleaners - Hub Pro XL	85
Hose Cutters	16
Hose Splicers	20
Hub Cap Pullers	87
Hub Centering Nuts	54
Hub Grinders	85
Hydraulic Coupler Dust Cover	70
Hydraulic Couplers	70
Hydraulic Hoses	70
Hydraulic Jack Oil	108

// I

Impact Socket Sets	48-51
Impact Sockets	52,53
Impact Sockets - Combination	53
Impact Wrench Parts & Accs.	28,37
Impact Wrenches - 1" Drive	24,25
Impact Wrenches - 1" Drive D-Handle	35
Impact Wrenches - 1/2" Drive	27-30
Inflation Cages	118,119
Injector Pump	168
Inner Liner Scraper	198
Inner Rim Cleaners	85

ALPHABETICAL INDEX (CONT.)

// J		// P (CONT.)		// S (CONT.)	
Jack Block _____	69	Pliers - Cutting _____	201,202	Socket Drivers _____	73,134
Jack Pads - Tesla _____	180	Pliers - Locking Jaw _____	187	Socket Extensions - Flip _____	73,134
Jack Plates _____	72	Plugs _____	18,19	Sockets - Flank Bite _____	80
Jack Stands - 10-Ton _____	67	Power Brushes _____	117	Sockets - Twist _____	80
Jack Stands - 22-Ton _____	60	Power Crimped Wheels _____	116	Spare Tire Tools Set _____	74
Jack Stands - 3, 6, 12-Ton _____	63,67	Pressure Cups _____	176	Spray Bottles _____	112
Jack Stands - High Reach _____	61	Pressure Rings _____	178	Sprayers _____	112,113
Jack Stands - Transmission _____	62	Pry Bar Set _____	189	Steering Wheel Covers _____	78
Jack Stands - Underhoist _____	62	Pry Bars _____	88	Stitchers _____	197
Jacks - Axle _____	66	// Q		Strip-Brite Pads _____	115
Jacks - Trac Tire _____	69	Quick Nuts _____	176	Stud Alignment Tools _____	70
Jacks - Truck _____	60	// R		Stud Cleaning Tools _____	83
Jacks - Truck Replacement Parts _____	60	Radiator Fillers _____	187	Stud Hub Brush Kit _____	84
// K		Rams _____	71	Stud Installers & Removers _____	56
Key Tags _____	77	Ratchet Tool Kits _____	36	Super Slick'em _____	111
Knives - Repair _____	195	Razor Blade Scraper _____	195	Surface Conditioning Discs _____	115,116
// L		Razor Blades _____	195	// T	
Leak Detectors _____	108	Reamers _____	200	Tap & Die Set _____	55
Lift Pads - Rubber _____	181	Repair Insert Kits _____	209	Tapers _____	200
Lights - COB Rechargeable _____	193	Repairs - Bias Heavy Duty _____	207	Thread Checker Set _____	147
Lights - Head _____	193	Repairs - Radial Heavy Duty _____	208	Tire & Tube Mounting Compounds _____	109
Lights - Pen _____	193	Repairs - Radial/Bias _____	206	Tire Bags _____	79
Lights - Work _____	194	Repairs - Strand Tire _____	208	Tire Branders Letters & Numbers _____	113,114
Locking Lug Keys & Sockets _____	82	Replacement Handles _____	94	Tire Buffer Accessories _____	23
Lube Buckets _____	105	Rib Nuts _____	56	Tire Buffers - High Speed _____	23,26
Lubricants _____	110,185	Rim Flange Clamp _____	92	Tire Buffers - Low Speed _____	22,26,32
Lug Nut Adapters _____	47	Rim Gauges _____	165	Tire Buffers - Low Speed Cordless _____	33,34
Lug Nut Cover Wrench _____	87	Rim Kote _____	110	Tire Cage Inflator Stand _____	119
Lug Nut Pullers _____	87	Rim Rust Retardant _____	108	Tire Carts _____	183
Lug Nut Removers _____	55	Rim Width Caliper _____	174	Tire Changers _____	213
Lug Nuts _____	46	Rotor Saws _____	200	Tire Changing System _____	91
Lug Off Kits _____	56	Rubber Blocks _____	182	Tire Denailer _____	198
// M		Rubber Covers _____	178	Tire Displays _____	184
Mag Tool Replacement Insert Kit _____	88	Rubber Rings _____	177	Tire Dollies _____	69,183
Mag-Bear _____	192	// S		Tire Flat Repair Kit _____	35
Manifold Kits _____	156	Safety Glasses _____	192	Tire Gauges - Adjustable Field Service _____	151
Mount Demount Heads _____	102,103	Screwdriver Sets _____	187	Tire Gauges - Automotive _____	151
// O		Sealers - Bead _____	204	Tire Gauges - Calibration _____	149
O-Rings _____	92	Sealers - Inner Liner _____	204	Tire Gauges - Digital Passenger _____	150
// P		Seat Covers _____	79	Tire Gauges - Digital Pocket _____	150
Paint Sticks _____	147	Serial Number Removal Tools _____	197	Tire Gauges - Digital Truck _____	150,152
Patch Plugs _____	205	Shank Balls _____	200	Tire Gauges - Dual Foot _____	151
Penetrants _____	108	Sidewall Wheels _____	199	Tire Gauges - Large Bore _____	152
		Skirt Nuts _____	54	Tire Gauges - Master _____	151
		Slick _____	112	Tire Gauges - Pocket Truck _____	151
				Tire Gauges - Truck Service _____	152
				Tire Inflator Kits - 4 Way _____	156

ALPHABETICAL INDEX (CONT.)

// T (CONT.)

Tire Inflators - Automatic	154
Tire Inflators - Digital	153-155
Tire Inflators - Hand Held	155
Tire Injury Measuring Tools	198
Tire Insert - Tubeless	208
Tire Labels	77,203
Tire Mounting Paste	109,110
Tire Paint - Black	110
Tire Press - Portable	93
Tire Pressure Value Sticker	125
Tire Probes, Rasps & Needles	198,203
Tire Regrooving Tools & Accessories	114
Tire Sealant	111
Tire Spreader	211,212
Tire Swabs	104
Tire Valves - Passenger	138
Tire Valves - Truck & Specialty	136
Tool Pouch - Tire Repair	198
Torque Chart	45
Torque Limiting Extensions	44,45
Torque Sockets	44,45,47
Torque Tools	133
Torque Wrench Extensions	43
Torque Wrenches - 1" Drive Preset	42
Torque Wrenches - 1/2" Drive	41
Torque Wrenches - 1/4" Drive	41
Torque Wrenches - Flex Hinge	43
Torque Wrenches - Preset Valve Nut	43,133
Torque Wrenches - Split Beam	40
Torque Wrenches - Square Drives	43
Torque Wrenches - Wheel Sets	39
TPMS - Diagnostic Tool	121
TPMS - Maxi Wifi Tool	121,122
TPMS Accessory Kits	125,135
TPMS Band	134
TPMS Mechanical Tool Kit	134
TPMS Sensors - Ascot By Autel	122
TPMS Sensors - EZ GO	126
TPMS Sensors - EZ Sensor Bundle	127
TPMS Sensors - Metal	122,124
TPMS Sensors - Rubber	122-124
TPMS Sensors - Tesla	124
TPMS Sensors - Universal	124
Tread Depth Gauges	145,146
Tread Depth Measurement Tool	121
Tube Repairs	206
Vacuum - Tire Repair	198
Valve & Core Tools	140-142,144

// V

Valve Breaker Tools	90
Valve Caps	129
Valve Cores	130
Valve Extensions - Air Flexx	137
Valve Inserts	126
Valve Stem Insertion & Removal Tools	139
Valve Stem Removal Tools	91
Valve Stem Replacement Kits	133
Valve Stem Wrenches	143
Valve Stems	130-132

// W

Water Adapter Set	94
Wheel Attaching Hardware	54
Wheel Bolt Measuring Tools	146,147
Wheel Chocks	75
Wheel Lock Removal Kits	81
Wheel Nut Indicators	86
Wheel Protector Sockets	80
Wheel Protectors	86
Wheel Stud Alignment Sets	55
Wheel Stud Service Kit	56
Wheel Weight Adhesive Removal Tools	31
Wheel Weight Application & Removal Tools	174
Wheel Weight Hammers	173,174
Wheel Weight Rack	164
Wheel Weight Roll Stand - Conversion Kits	164
Wheel Weight Roll Stands	164
Wheel Weight Roll Wire Hangers	164
Wheel Weight Sample Kits	163
Wheel Weight Scrapers	175
Wheel Weights - FN, Lead	161,163
Wheel Weights - Lead Adhesive	165
Wheel Weights - MC, Lead	161,163
Wheel Weights - MC, Lead Uncoated	162
Wheel Weights - P, Lead Uncoated	162
Wheel Weights - P, Steel	162
Wheel Weights - Steel Adhesive	165-167
Wheel Weights - T, Lead	162
Wheel Weights - Zinc Import	163
Wire Pullers	205
Wire Wheels	116
Work Bench - Heavy Duty	211
Work Ticket Holders	78
Wrench Extenders	189
Wrenches - Drain Plug	187
Wrenches - Open End Combination	190



NUMERIC INDEX

107-00125	17	131-61579	18	157-03253	31	163-10280	52	165-30481	53
107-69102	17	131-62523	18	157-03254	31	163-10281	52	165-30482	53
111-30002	14	133-01855	18	157-10874	32	163-10282	52	166-04026	53
111-35201	14	133-61471	18	157-10875	32	163-10300	52	166-04033	53
111-35203	14	133-61563	18	157-48520	33	163-10401	52	166-04191	50
111-35301	14	133-61568	18	157-48522	33	163-11032	52	166-04323	53
111-35401	14	133-61569	18	158-01871	26	163-15260	52	167-01012	73,134
111-35403	14	135-10605	19,70	158-02873	26	163-22219	49,80	167-01015	73,134
111-37600	14	135-10606	19,70	158-03873	26	163-28492	80	167-12050	50
112-00162	14	135-10607	19,70	158-10871	23	163-28494	80	167-12051	51
112-00352	14	135-11606	19,70	158-10873	22	163-28496	80	167-12110	52,134
112-00376	14	135-12606	19,70	158-11871	23	163-28498	80	167-12179	52
112-01352	14	136-71404	20	158-11873	22	163-28917	80	167-12460	52
112-01354	14	136-71406	20	158-40922	33	163-28919	80	167-12461	52
113-01352	14	136-71408	20	158-45922	35	163-28921	80	167-12490	52
113-01354	14	136-71440	20	163-00440	47	164-02024	52	167-12910	52
114-03352	15	136-71604	20	163-01018	52	164-02026	52	167-12911	52
114-03354	15	136-71606	20	163-01019	52	164-02033	52	167-12912	52
114-13354	15	136-71806	20	163-01021	52	164-02038	52	167-18195	52
114-75202	15	136-71808	20	163-01022	52	164-02110	48	167-21215	52
114-75400	15	136-72404	20	163-01024	52	164-02181	49	167-21225	52
117-00935	15	137-11420	16	163-01026	52	164-02235	53	167-22225	52
117-05702	15	153-02235	28	163-01032	52	164-02241	53	168-00058	43,133
117-11481	15	153-02312	27	163-01033	52	164-20301	52	168-00250	40
121-01225	16	153-12260	28	163-01034	52	165-03021	53	168-00251	40
121-01250	16	153-22235	28	163-01036	52	165-03026	53	168-00425	41
121-03825	16	153-22360	29	163-01048	52	165-03030	53	168-00475	45
121-03851	16	153-22362	29	163-01150	48	165-03033	53	168-00600	40
121-14700	16	153-23120	27	163-01151	48	165-03035	53	168-00601	40
123-13825	17	153-42235	28	163-01152	48	165-03041	53	168-00652	41
123-14012	17	153-76920	34	163-01153	49	165-03042	53	168-00916	43,133
123-14025	17	153-76922	34	163-02668	48	165-03046	53	168-01224	189
123-38050	17	153-77412	30	163-02669	48	165-03052	53	168-01475	45
123-38125	17	153-77482	30	163-02849	80	165-03056	53	168-02024	45
125-00760	16	155-02856	24	163-05153	49	165-03060	53	168-02880	44
126-00761	16	155-12856	25	163-10143	52	165-03110	49	168-04994	44
127-86871	105	155-17782	24	163-10170	52	165-03119	50	168-12065	39
127-86872	105	155-17786	25	163-10171	52	165-03190	50	168-12080	39
128-00006	17	155-26464	25	163-10172	52	165-03197	51	168-12100	39
131-01750	18	155-77826	24	163-10174	52	165-03321	53	168-12120	39
131-61523	18	155-86722	34	163-10183	52	165-03323	53	168-12140	39
131-61526	18	155-86920	35	163-10190	52	165-30302	53	168-12250	41
131-61527	18	155-86922	35	163-10191	52	165-30361	53	168-12410	44
131-61529	18	156-28566	24	163-10210	52	165-30380	53	168-12412	44
131-61531	19	157-00874	26	163-10211	52	165-30381	53	168-12414	44
131-61538	18	157-00875	26	163-10222	52	165-30401	53	168-12450	44
131-61539	18	157-01035	32	163-10223	52	165-30402	53	168-12465	45
131-61573	18	157-01327	32	163-10241	52	165-30410	53	168-12480	44
131-61578	18	157-03252	31	163-10271	52	165-30420	53	168-13000	39

NUMERIC INDEX (CONT.)

168-16000 _____ 39	175-18713 _____ 23	302-61401 _____ 58	316-01315 _____ 21	395-00101 _____ 186
168-21780 _____ 44	175-23104 _____ 28	302-61402 _____ 58	316-01518 _____ 21	395-00102 _____ 186
168-21910 _____ 44	175-28713 _____ 23	302-61403 _____ 58	316-01720 _____ 21	395-00103 _____ 186
168-21980 _____ 44	175-52122 _____ 37	302-61404 _____ 58	316-01922 _____ 21	395-00104 _____ 186
168-22212 _____ 44	175-82651 _____ 37	302-63030 _____ 63	316-02023 _____ 21	395-00125 _____ 186
168-22214 _____ 44	175-83071 _____ 37	302-63060 _____ 63	316-91098 _____ 21	395-00126 _____ 186
168-22610 _____ 44	175-94791 _____ 37	302-63120 _____ 63	318-04120 _____ 70	395-00400 _____ 186
168-47501 _____ 42	176-18406 _____ 25	302-91503 _____ 60	318-04960 _____ 70	395-06400 _____ 186
168-47502 _____ 42	181-00016 _____ 38	302-91504 _____ 60	318-10518 _____ 96	395-06401 _____ 186
168-60011 _____ 43	181-00080 _____ 38	302-91505 _____ 60	318-11518 _____ 96	395-06402 _____ 186
168-60012 _____ 43	181-00085 _____ 38	309-00003 _____ 181	318-13000 _____ 71	395-13124 _____ 106
168-60025 _____ 43	181-00404 _____ 38	309-00005 _____ 182	318-13120 _____ 71	395-40000 _____ 186
168-61019 _____ 43	181-00406 _____ 38	309-00006 _____ 181	318-13154 _____ 71	396-00003 _____ 75
168-80246 _____ 41	301-05620 _____ 65	309-00007 _____ 182	318-13155 _____ 71	396-00102 _____ 75
168-96509 _____ 39	301-05621 _____ 65	309-00009 _____ 181	318-15905 _____ 96	396-00301 _____ 191
169-01002 _____ 53,134	301-05630 _____ 65	309-00011 _____ 182	319-00012 _____ 55	396-00302 _____ 191
169-01003 _____ 53	301-14460 _____ 68	309-00013 _____ 182	319-00033 _____ 88	396-00303 _____ 191
169-01005 _____ 53	301-14461 _____ 68	309-00014 _____ 181	319-00337 _____ 201	396-00304 _____ 191
169-01020 _____ 53	301-20220 _____ 59	309-00022 _____ 181	319-00358 _____ 201	396-00357 _____ 78
169-01234 _____ 50	301-20221 _____ 59	309-00404 _____ 180	319-00447 _____ 201	396-00401 _____ 191
169-02006 _____ 53	301-20222 _____ 59	309-00405 _____ 180	319-01023 _____ 187	396-00402 _____ 191
169-02010 _____ 53	301-20224 _____ 59	309-10925 _____ 108	319-01024 _____ 187	396-00403 _____ 191
169-02013 _____ 53	301-20225 _____ 59	309-12121 _____ 72	319-01337 _____ 202	396-00404 _____ 191
169-02030 _____ 53	301-20226 _____ 59	309-14464 _____ 72	319-01358 _____ 202	396-00405 _____ 191
169-03006 _____ 53	301-20227 _____ 59	309-14465 _____ 72	319-01447 _____ 202	396-00803 _____ 191
169-03010 _____ 53	301-20228 _____ 59	309-14472 _____ 72	319-02080 _____ 189	396-00804 _____ 191
169-03013 _____ 53	301-20229 _____ 59	309-18181 _____ 72	319-02081 _____ 189	396-00805 _____ 191
169-03020 _____ 53	301-20255 _____ 59	309-48501 _____ 69	319-03732 _____ 19	396-00901 _____ 192
169-13413 _____ 43	302-00200 _____ 64	309-48511 _____ 69	319-19800 _____ 187	396-00902 _____ 192
169-20100 _____ 53	302-02811 _____ 61	312-03007 _____ 193	319-46464 _____ 142	396-10011 _____ 192
172-55721 _____ 36	302-02812 _____ 62	312-07179 _____ 193	319-72521 _____ 73	396-15300 _____ 75
173-00018 _____ 37	302-05601 _____ 58	312-08473 _____ 194	319-76403 _____ 88	396-50317 _____ 191
173-00019 _____ 37	302-05602 _____ 58	312-14923 _____ 194	319-96090 _____ 74	396-50318 _____ 191
173-00020 _____ 37	302-05605 _____ 57	312-39001 _____ 193	319-96091 _____ 74	396-50319 _____ 191
173-00022 _____ 37	302-05613 _____ 58	313-00058 _____ 143	319-96092 _____ 74	396-50320 _____ 191
173-00023 _____ 37	302-05614 _____ 57	313-00158 _____ 143	319-96093 _____ 74	396-55220 _____ 192
173-00024 _____ 37	302-05622 _____ 60	313-00385 _____ 189	319-96094 _____ 74	396-95055 _____ 192
173-00025 _____ 37	302-19150 _____ 60	313-00916 _____ 143	319-96095 _____ 74	399-74980 _____ 76
173-00026 _____ 37	302-19156 _____ 60	313-01219 _____ 187	322-02444 _____ 184	399-98313 _____ 77
173-00027 _____ 37	302-20147 _____ 60	313-01916 _____ 143	322-19822 _____ 184	399-98893 _____ 79
175-00041 _____ 29	302-28112 _____ 61	313-09411 _____ 190	322-90045 _____ 184	399-99302 _____ 78
175-00042 _____ 29	302-35002 _____ 64	313-09415 _____ 190	328-00016 _____ 185	399-99323 _____ 77
175-00061 _____ 29	302-40000 _____ 66	313-09511 _____ 190	328-00116 _____ 185	399-99391 _____ 79
175-00062 _____ 29	302-45035 _____ 69	313-09515 _____ 190	329-18685 _____ 187	399-99392 _____ 79
175-00066 _____ 29	302-51005 _____ 67	316-00058 _____ 21	342-00608 _____ 214	399-99415 _____ 79
175-00142 _____ 29	302-55200 _____ 64	316-00102 _____ 21	345-11812 _____ 36	399-99429 _____ 79
175-00162 _____ 29	302-56502 _____ 66	316-00911 _____ 21	345-11835 _____ 36	399-99432 _____ 76
175-00873 _____ 23	302-60129 _____ 58	316-01098 _____ 21	345-11850 _____ 36	399-99433 _____ 78
175-11035 _____ 32	302-61301 _____ 58	316-01113 _____ 21	371-03321 _____ 62	399-99479 _____ 77

NUMERIC INDEX (CONT.)

401-02840 _____ 81	402-43358 _____ 85	431-00055 _____ 111	444-17985 _____ 104	451-02640 _____ 111
401-02841 _____ 81	402-46300 _____ 85	432-02000 _____ 109	444-22019 _____ 104	451-32016 _____ 170
402-00013 _____ 83	402-46340 _____ 85	432-02005 _____ 109	444-23614 _____ 104	451-40004 _____ 170
402-00022 _____ 83	402-46350 _____ 85	432-02008 _____ 109	444-59408 _____ 103	451-40006 _____ 170
402-00113 _____ 83	402-72100 _____ 87	432-02014 _____ 109	444-70201 _____ 88	451-40008 _____ 170
402-00114 _____ 83	404-67300 _____ 55	432-02028 _____ 109	444-70202 _____ 88	451-40010 _____ 170
402-00116 _____ 83	407-03000 _____ 69	432-02029 _____ 109	444-70204 _____ 88	451-40012 _____ 170
402-00122 _____ 83	408-00116 _____ 108	432-02035 _____ 109	444-81354 _____ 104	451-40016 _____ 170
402-00128 _____ 83	411-03218 _____ 145	432-02046 _____ 109	444-82961 _____ 103	452-00001 _____ 113
402-00222 _____ 85	411-65201 _____ 145	432-02067 _____ 109	444-82963 _____ 103	452-00011 _____ 113
402-00322 _____ 85	411-71000 _____ 73	432-02088 _____ 109	444-99719 _____ 104	452-00012 _____ 113
402-01283 _____ 82	417-12612 _____ 115	432-02146 _____ 110	448-00010 _____ 89	452-00014 _____ 113
402-01322 _____ 83	417-12613 _____ 115	432-02167 _____ 110	448-01101 _____ 89	452-00100 _____ 113
402-02312 _____ 51	417-12614 _____ 115	432-12046 _____ 109	448-01102 _____ 89	452-00101 _____ 113
402-03016 _____ 87	417-12615 _____ 115	432-12067 _____ 109	448-12320 _____ 91	452-00102 _____ 113
402-03116 _____ 87	417-12617 _____ 115	432-57270 _____ 112	448-12894 _____ 89	452-00103 _____ 113
402-06002 _____ 87	417-12618 _____ 115	432-57304 _____ 112	448-22320 _____ 91	452-00104 _____ 113
402-11000 _____ 86	417-12619 _____ 115	432-57305 _____ 112	448-22894 _____ 89	452-00105 _____ 113
402-16000 _____ 86	417-12704 _____ 116	432-57355 _____ 112	448-32320 _____ 91	452-00106 _____ 113
402-17000 _____ 86	417-12705 _____ 116	433-01950 _____ 110	448-32894 _____ 89	452-00107 _____ 113
402-20015 _____ 86	417-13003 _____ 115	433-01957 _____ 110	448-93500 _____ 92	452-00108 _____ 113
402-20021 _____ 86	417-13004 _____ 115	433-01958 _____ 110	451-00014 _____ 168	452-00109 _____ 113
402-20030 _____ 86	417-13005 _____ 115	433-02020 _____ 110	451-00036 _____ 111	452-00112 _____ 113
402-20033 _____ 86	417-13006 _____ 115	433-02022 _____ 110	451-00100 _____ 170	452-00114 _____ 113
402-20078 _____ 86	417-13007 _____ 115	433-02023 _____ 110	451-00150 _____ 170	452-00201 _____ 113
402-20114 _____ 86	417-16210 _____ 115	433-10231 _____ 108	451-00200 _____ 170	452-00202 _____ 113
402-20233 _____ 86	417-16211 _____ 115	433-10232 _____ 108	451-00203 _____ 168	452-00203 _____ 113
402-20333 _____ 86	417-39120 _____ 115	433-25430 _____ 108	451-00204 _____ 168	452-00204 _____ 113
402-20408 _____ 91	417-39121 _____ 115	433-25431 _____ 108	451-00205 _____ 168	452-00205 _____ 113
402-28301 _____ 82	417-39122 _____ 115	434-02110 _____ 110	451-00206 _____ 168	452-00206 _____ 113
402-28302 _____ 82	417-39202 _____ 116	434-02120 _____ 110	451-00208 _____ 168	452-00207 _____ 113
402-28305 _____ 82	417-39203 _____ 116	435-06001 _____ 108	451-00210 _____ 168	452-00209 _____ 113
402-28306 _____ 82	421-03842 _____ 90	435-06002 _____ 108	451-00212 _____ 168	452-00211 _____ 113
402-28307 _____ 82	421-12904 _____ 111	435-06008 _____ 108	451-00214 _____ 168	452-00212 _____ 113
402-28308 _____ 82	421-71750 _____ 93	437-00001 _____ 104	451-00216 _____ 168	452-00213 _____ 113
402-28309 _____ 82	422-10165 _____ 93	437-00002 _____ 104	451-00250 _____ 170	452-00214 _____ 113
402-28310 _____ 82	422-11000 _____ 92	437-00003 _____ 104	451-00300 _____ 170	452-00215 _____ 113
402-28316 _____ 82	422-11010 _____ 92	437-13014 _____ 104	451-00400 _____ 170	452-00216 _____ 113
402-31568 _____ 87	422-11025 _____ 92	441-00202 _____ 213	451-00500 _____ 170	452-00217 _____ 113
402-32610 _____ 84	422-11076 _____ 93	441-00220 _____ 213	451-00618 _____ 169	452-00218 _____ 113
402-32613 _____ 84	422-94549 _____ 96	444-01220 _____ 103	451-00640 _____ 111	452-00219 _____ 113
402-32615 _____ 84	426-29150 _____ 189	444-01221 _____ 103	451-01203 _____ 169	452-00220 _____ 113
402-32616 _____ 84	427-01322 _____ 90	444-01222 _____ 102	451-01204 _____ 169	452-00221 _____ 113
402-37330 _____ 85	429-10005 _____ 93	444-01223 _____ 103	451-01206 _____ 169	452-00222 _____ 113
402-37335 _____ 85	429-10010 _____ 93	444-01224 _____ 102	451-01208 _____ 169	452-00223 _____ 113
402-37340 _____ 85	429-32344 _____ 94	444-01225 _____ 103	451-01210 _____ 169	452-00224 _____ 113
402-43351 _____ 85	429-35832 _____ 94	444-01226 _____ 102	451-01212 _____ 169	452-00226 _____ 113
402-43352 _____ 85	431-00001 _____ 111	444-01228 _____ 102	451-01214 _____ 169	452-00401 _____ 114
402-43357 _____ 85	431-00005 _____ 111	444-01230 _____ 102	451-01216 _____ 169	452-00402 _____ 114

NUMERIC INDEX (CONT.)

452-00403 _____ 114	452-01100 _____ 114	461-01414 _____ 138	468-01000 _____ 137	469-01820 _____ 143
452-00404 _____ 114	452-01101 _____ 114	461-01418 _____ 138	468-01120 _____ 205	469-03333 _____ 139
452-00405 _____ 114	452-01102 _____ 114	461-20326 _____ 124	468-01765 _____ 129	469-08288 _____ 142
452-00406 _____ 114	452-01103 _____ 114	461-20327 _____ 124	468-02222 _____ 129	469-10110 _____ 134
452-00407 _____ 114	452-01104 _____ 114	461-20328 _____ 124	468-04191 _____ 129	469-10415 _____ 134
452-00408 _____ 114	452-01105 _____ 114	461-20329 _____ 124	468-09002 _____ 130	469-10715 _____ 134
452-00409 _____ 114	452-01106 _____ 114	461-20331 _____ 124	468-10015 _____ 129	469-11115 _____ 142
452-00410 _____ 114	452-01107 _____ 114	461-30100 _____ 124	468-10046 _____ 129	469-11610 _____ 140
452-00411 _____ 114	452-01108 _____ 114	461-30326 _____ 122	468-17492 _____ 125	469-11710 _____ 140
452-00412 _____ 114	452-01109 _____ 114	461-30327 _____ 122	468-20055 _____ 130	469-11810 _____ 140
452-00413 _____ 114	452-02100 _____ 114	461-30328 _____ 123	468-20495 _____ 129	469-11910 _____ 140
452-00414 _____ 114	452-02101 _____ 114	461-30329 _____ 123	468-20595 _____ 129	469-15415 _____ 133
452-00415 _____ 114	452-02102 _____ 114	461-30331 _____ 123	468-59019 _____ 129	469-15535 _____ 133
452-00416 _____ 114	452-02103 _____ 114	461-33500 _____ 126	468-59021 _____ 129	469-17107 _____ 125
452-00418 _____ 114	452-02104 _____ 114	461-33560 _____ 126	468-74920 _____ 129	469-17208 _____ 125
452-00419 _____ 114	452-02105 _____ 114	461-33561 _____ 126	468-74921 _____ 129	469-17213 _____ 125
452-00420 _____ 114	452-02106 _____ 114	461-33562 _____ 126	469-00001 _____ 140	469-17216 _____ 125
452-00421 _____ 114	452-02107 _____ 114	461-33700 _____ 126	469-00002 _____ 140	469-17218 _____ 125
452-00422 _____ 114	452-02108 _____ 114	461-41311 _____ 138	469-00003 _____ 140	469-17221 _____ 125
452-00423 _____ 114	452-02109 _____ 114	461-59357 _____ 126	469-00004 _____ 140	469-17222 _____ 125
452-00424 _____ 114	454-00190 _____ 145	461-59387 _____ 126	469-00005 _____ 140	469-17223 _____ 125
452-00425 _____ 114	454-00200 _____ 121	462-00416 _____ 138	469-00011 _____ 141	469-17224 _____ 125
452-00426 _____ 114	454-00209 _____ 145	462-11147 _____ 136	469-00012 _____ 140	469-17226 _____ 125
452-00501 _____ 114	454-00599 _____ 145	463-00500 _____ 136	469-00014 _____ 139	469-17228 _____ 125
452-00502 _____ 114	454-00712 _____ 145	463-00501 _____ 136	469-00018 _____ 143	469-17245 _____ 131
452-00503 _____ 114	454-01420 _____ 146	463-00572 _____ 136	469-00020 _____ 143	469-17246 _____ 132
452-00504 _____ 114	454-01599 _____ 145	463-00573 _____ 136	469-00021 _____ 141	469-17272 _____ 125
452-00505 _____ 114	454-03000 _____ 147	463-00575 _____ 136	469-00024 _____ 141	469-17275 _____ 125
452-00506 _____ 114	454-06763 _____ 146	463-02554 _____ 136	469-00040 _____ 139	469-17296 _____ 125
452-00507 _____ 114	454-11410 _____ 146	463-05434 _____ 136	469-00044 _____ 142	469-17311 _____ 125
452-00508 _____ 114	455-00003 _____ 114	463-05435 _____ 136	469-00123 _____ 144	469-17316 _____ 125
452-00509 _____ 114	455-00401 _____ 114	463-05444 _____ 136	469-00208 _____ 131	469-17317 _____ 125
452-00510 _____ 114	455-00402 _____ 114	464-00618 _____ 136	469-00443 _____ 141	469-17389 _____ 131
452-00511 _____ 114	455-00403 _____ 114	464-92837 _____ 94	469-00580 _____ 144	469-17392 _____ 132
452-00512 _____ 114	455-00404 _____ 114	468-00050 _____ 129	469-00607 _____ 140	469-17393 _____ 132
452-00513 _____ 114	455-00405 _____ 114	468-00075 _____ 137	469-00609 _____ 141	469-17395 _____ 132
452-00514 _____ 114	455-00406 _____ 114	468-00085 _____ 137	469-00610 _____ 144	469-17397 _____ 132
452-00515 _____ 114	459-80220 _____ 147	468-00105 _____ 137	469-00612 _____ 144	469-17398 _____ 132
452-00516 _____ 114	459-80221 _____ 147	468-00107 _____ 129	469-00619 _____ 141	469-17420 _____ 125
452-00517 _____ 114	459-80257 _____ 147	468-00145 _____ 137	469-00673 _____ 142	469-17538 _____ 131
452-00518 _____ 114	459-80258 _____ 147	468-00149 _____ 129	469-00850 _____ 139	469-17539 _____ 125
452-00519 _____ 114	459-80271 _____ 147	468-00185 _____ 137	469-00925 _____ 130	469-17539 _____ 132
452-00520 _____ 114	461-00412 _____ 138	468-00202 _____ 129	469-00950 _____ 130	469-20007 _____ 135
452-00521 _____ 114	461-00413 _____ 138	468-00203 _____ 136	469-00992 _____ 139	469-20009 _____ 135
452-00522 _____ 114	461-00414 _____ 138	468-00207 _____ 129	469-01115 _____ 142	469-20013 _____ 135
452-00523 _____ 114	461-00415 _____ 138	468-00215 _____ 137	469-01124 _____ 139	469-20014 _____ 135
452-00524 _____ 114	461-00600 _____ 138	468-00315 _____ 137	469-01426 _____ 134	469-20017 _____ 135
452-00525 _____ 114	461-00800 _____ 138	468-00401 _____ 138	469-01638 _____ 139	469-20018 _____ 131
452-00526 _____ 114	461-01413 _____ 138	468-00415 _____ 137	469-01690 _____ 140	469-20019 _____ 135

NUMERIC INDEX (CONT.)

469-20020 _____ 135	473-00501 _____ 99	476-00941 _____ 149	477-00066 _____ 157	478-03370 _____ 158
469-20030 _____ 135	473-01104 _____ 100	476-01046 _____ 149	477-00099 _____ 157	478-04660 _____ 159
469-20032 _____ 135	473-01106 _____ 100	476-03238 _____ 150	477-00111 _____ 157	478-05451 _____ 158
469-20035 _____ 135	473-01107 _____ 100	476-07285 _____ 151	477-00112 _____ 157	478-06585 _____ 159
469-20036 _____ 135	473-01110 _____ 100	476-10100 _____ 151	477-00113 _____ 157	478-32072 _____ 159
469-20140 _____ 133	473-01113 _____ 100	476-10105 _____ 151	477-00115 _____ 157	479-36001 _____ 118
469-20279 _____ 124	473-01118 _____ 100	476-10115 _____ 151	477-00116 _____ 157	479-36002 _____ 118
469-20280 _____ 124	473-01230 _____ 100	476-10125 _____ 151	477-00117 _____ 157	479-36005 _____ 118
469-20281 _____ 124	473-01500 _____ 97	476-10130 _____ 151	477-00118 _____ 157	479-36006 _____ 118
469-20282 _____ 124	473-01502 _____ 98	476-10135 _____ 152	477-00144 _____ 157	479-36011 _____ 118
469-20283 _____ 124	473-01504 _____ 98	476-10140 _____ 151	477-01006 _____ 157	479-36013 _____ 118
469-20284 _____ 125	473-01506 _____ 98	476-10145 _____ 151	477-01009 _____ 157	479-36015 _____ 118
469-20598 _____ 135	473-01509 _____ 98	476-10150 _____ 151	477-01012 _____ 157	479-36111 _____ 118
469-21298 _____ 127	473-01510 _____ 98	476-10155 _____ 152	477-01025 _____ 157	479-36112 _____ 119
469-22011 _____ 91	473-01516 _____ 98	476-10160 _____ 151	477-01111 _____ 157	479-46001 _____ 119
469-22012 _____ 144	473-01518 _____ 98	476-10165 _____ 152	477-01112 _____ 157	479-46002 _____ 119
469-22481 _____ 135	473-02102 _____ 100	476-10185 _____ 152	477-10001 _____ 155	479-46005 _____ 119
469-22482 _____ 135	473-02103 _____ 100	476-10240 _____ 152	477-10004 _____ 155	479-46006 _____ 119
469-23430 _____ 144	473-02106 _____ 100	476-10255 _____ 152	477-10008 _____ 155	479-46011 _____ 119
469-25415 _____ 133	473-02107 _____ 100	476-10480 _____ 152	477-10312 _____ 154	482-09011 _____ 174
469-25535 _____ 133	473-02501 _____ 97	476-10500 _____ 150	477-11111 _____ 157	483-08002 _____ 177
469-32011 _____ 90	473-02505 _____ 97	476-11135 _____ 152	477-11235 _____ 153	483-08005 _____ 178
469-32855 _____ 144	473-02510 _____ 98	476-11148 _____ 152	477-11237 _____ 153	483-08027 _____ 178
469-32856 _____ 144	473-02511 _____ 98	476-11155 _____ 152	477-11239 _____ 153	483-08065 _____ 177
469-34000 _____ 130	473-02513 _____ 98	476-11165 _____ 152	477-11240 _____ 153	483-16572 _____ 177
469-50816 _____ 121	473-03102 _____ 100	476-11185 _____ 152	477-11612 _____ 154	483-16822 _____ 177
469-51632 _____ 142	473-03103 _____ 100	476-11250 _____ 152	477-11623 _____ 156	483-40060 _____ 178
469-51812 _____ 122	473-03104 _____ 100	476-15038 _____ 152	477-11624 _____ 156	483-40062 _____ 178
469-52000 _____ 144	473-03106 _____ 100	476-32380 _____ 150	477-11625 _____ 156	483-40091 _____ 176
469-60000 _____ 121	473-04103 _____ 100	476-32922 _____ 151	477-47732 _____ 156	483-40110 _____ 179
469-90660 _____ 133	473-05102 _____ 100	476-35020 _____ 153	478-00001 _____ 158	483-40132 _____ 179
469-91322 _____ 135	473-06813 _____ 100	476-35021 _____ 153	478-00305 _____ 158	483-40301 _____ 176
471-80007 _____ 92	473-12913 _____ 101	477-00001 _____ 157	478-00315 _____ 158	483-40401 _____ 176
471-80008 _____ 92	473-12914 _____ 101	477-00002 _____ 157	478-00322 _____ 159	483-40800 _____ 176
471-80010 _____ 92	473-12915 _____ 101	477-00003 _____ 157	478-00325 _____ 158	483-40801 _____ 176
471-80012 _____ 92	473-12916 _____ 101	477-00004 _____ 157	478-00328 _____ 159	483-40806 _____ 176
471-80017 _____ 92	473-12917 _____ 101	477-00005 _____ 157	478-00335 _____ 158	483-99409 _____ 179
471-80018 _____ 92	473-12919 _____ 101	477-00006 _____ 157	478-00340 _____ 158	484-00006 _____ 165
471-80110 _____ 92	473-12920 _____ 101	477-00007 _____ 157	478-00377 _____ 159	484-00112 _____ 165
471-80112 _____ 92	473-12923 _____ 101	477-00008 _____ 157	478-01330 _____ 158	484-10100 _____ 166
473-00010 _____ 99	473-12930 _____ 101	477-00009 _____ 157	478-01335 _____ 158	484-10101 _____ 166
473-00011 _____ 99	473-22181 _____ 101	477-00010 _____ 157	478-01350 _____ 158	484-10102 _____ 166
473-00013 _____ 99	475-15103 _____ 94	477-00011 _____ 157	478-01352 _____ 158	484-10200 _____ 166
473-00103 _____ 101	475-30280 _____ 94	477-00012 _____ 157	478-02985 _____ 158	484-10201 _____ 166
473-00106 _____ 101	475-30281 _____ 94	477-00014 _____ 157	478-02995 _____ 158	484-10300 _____ 166
473-00110 _____ 101	476-00165 _____ 149	477-00015 _____ 157	478-03300 _____ 158	484-10301 _____ 166
473-00207 _____ 99	476-00211 _____ 149	477-00020 _____ 157	478-03301 _____ 158	484-10400 _____ 166
473-00500 _____ 99	476-00255 _____ 149	477-00033 _____ 157	478-03330 _____ 158	484-10720 _____ 165

NUMERIC INDEX (CONT.)

484-11360 _____ 165	486-31282 _____ 164	488-13025 _____ 162	488-33035 _____ 161	488-56250 _____ 161
484-13360 _____ 165	486-31283 _____ 164	488-13050 _____ 162	488-33040 _____ 161	488-56275 _____ 161
484-16001 _____ 165	486-31284 _____ 164	488-13075 _____ 162	488-43005 _____ 163	488-56300 _____ 161
484-17026 _____ 165	486-31285 _____ 164	488-13100 _____ 162	488-43010 _____ 163	488-81025 _____ 163
484-17127 _____ 165	486-33580 _____ 173	488-13125 _____ 162	488-43015 _____ 163	488-81050 _____ 163
484-20576 _____ 165	486-33581 _____ 173	488-13150 _____ 162	488-43020 _____ 163	488-81075 _____ 163
484-21576 _____ 167	486-33584 _____ 173	488-13175 _____ 162	488-43025 _____ 163	488-81100 _____ 163
484-21624 _____ 167	486-48301 _____ 175	488-13200 _____ 162	488-43030 _____ 163	488-81125 _____ 163
484-22576 _____ 165	486-71510 _____ 175	488-13225 _____ 162	488-43035 _____ 163	488-81150 _____ 163
484-23576 _____ 167	486-71511 _____ 175	488-13250 _____ 162	488-43040 _____ 163	488-81175 _____ 163
484-28408 _____ 166	486-71512 _____ 175	488-19025 _____ 161	488-43045 _____ 163	488-81200 _____ 163
484-28428 _____ 166	486-75011 _____ 165	488-19050 _____ 161	488-43050 _____ 163	488-81225 _____ 163
484-30224 _____ 165	487-12025 _____ 162	488-19075 _____ 161	488-49025 _____ 163	488-81250 _____ 163
484-30360 _____ 165	487-12050 _____ 162	488-19100 _____ 161	488-49050 _____ 163	488-81275 _____ 163
484-31234 _____ 166	487-12075 _____ 162	488-19125 _____ 161	488-49075 _____ 163	488-81300 _____ 163
484-31360 _____ 165	487-12100 _____ 162	488-19150 _____ 161	488-49100 _____ 163	488-83025 _____ 163
484-32224 _____ 165	487-12125 _____ 162	488-19175 _____ 161	488-49125 _____ 163	488-83050 _____ 163
484-32360 _____ 167	487-12150 _____ 162	488-19200 _____ 161	488-49150 _____ 163	488-83075 _____ 163
484-33224 _____ 167	487-12175 _____ 162	488-19225 _____ 161	488-49175 _____ 163	488-83100 _____ 163
484-35320 _____ 167	487-12200 _____ 162	488-19250 _____ 161	488-49200 _____ 163	488-83125 _____ 163
484-35420 _____ 167	487-12225 _____ 162	488-19275 _____ 161	488-49225 _____ 163	488-83150 _____ 163
484-37026 _____ 165	487-12250 _____ 162	488-19300 _____ 161	488-49250 _____ 163	488-83175 _____ 163
484-40848 _____ 166	487-12275 _____ 162	488-23010 _____ 161	488-49275 _____ 163	488-83200 _____ 163
484-42010 _____ 167	487-12300 _____ 162	488-23015 _____ 161	488-49300 _____ 163	488-83225 _____ 163
484-47026 _____ 167	487-28025 _____ 162	488-23020 _____ 161	488-53010 _____ 161	488-83250 _____ 163
484-50615 _____ 166	487-28050 _____ 162	488-23025 _____ 161	488-53015 _____ 161	488-83275 _____ 163
484-51500 _____ 167	487-28075 _____ 162	488-23030 _____ 161	488-53020 _____ 161	488-83300 _____ 163
484-51501 _____ 167	487-28100 _____ 162	488-23035 _____ 161	488-53025 _____ 161	488-84010 _____ 163
484-52312 _____ 166	487-28125 _____ 162	488-23040 _____ 161	488-53030 _____ 161	488-84015 _____ 163
484-61500 _____ 167	487-28150 _____ 162	488-23045 _____ 161	488-53035 _____ 161	488-84020 _____ 163
484-61501 _____ 167	487-28175 _____ 162	488-23050 _____ 161	488-53040 _____ 161	488-84025 _____ 163
484-67026 _____ 165	487-28200 _____ 162	488-23055 _____ 161	488-55025 _____ 162	488-84030 _____ 163
484-71500 _____ 167	487-28225 _____ 162	488-23060 _____ 161	488-55050 _____ 162	488-84035 _____ 163
484-71501 _____ 167	487-28250 _____ 162	488-29025 _____ 161	488-55075 _____ 162	488-84040 _____ 163
484-77026 _____ 165	487-28275 _____ 162	488-29050 _____ 161	488-55100 _____ 162	488-84045 _____ 163
486-00011 _____ 173	487-28300 _____ 162	488-29075 _____ 161	488-55125 _____ 162	488-84050 _____ 163
486-00044 _____ 174	487-35025 _____ 162	488-29100 _____ 161	488-55150 _____ 162	488-86025 _____ 163
486-00133 _____ 174	487-35050 _____ 162	488-29125 _____ 161	488-55175 _____ 162	488-86050 _____ 163
486-00144 _____ 174	487-35075 _____ 162	488-29150 _____ 161	488-55200 _____ 162	488-86075 _____ 163
486-00222 _____ 174	487-35100 _____ 162	488-29175 _____ 161	488-56025 _____ 161	488-86100 _____ 163
486-00233 _____ 174	487-35125 _____ 162	488-29200 _____ 161	488-56050 _____ 161	488-86125 _____ 163
486-00234 _____ 163	487-35150 _____ 162	488-29225 _____ 161	488-56075 _____ 161	488-86150 _____ 163
486-05323 _____ 163	487-35175 _____ 162	488-29250 _____ 161	488-56100 _____ 161	488-86175 _____ 163
486-09462 _____ 163	487-35200 _____ 162	488-33010 _____ 161	488-56125 _____ 161	488-86200 _____ 163
486-11000 _____ 173	487-35225 _____ 162	488-33015 _____ 161	488-56150 _____ 161	488-86225 _____ 163
486-11006 _____ 173	487-35250 _____ 162	488-33020 _____ 161	488-56175 _____ 161	488-86250 _____ 163
486-31280 _____ 164	487-35275 _____ 162	488-33025 _____ 161	488-56200 _____ 161	488-86275 _____ 163
486-31281 _____ 164	487-35300 _____ 162	488-33030 _____ 161	488-56225 _____ 161	488-86300 _____ 163

NUMERIC INDEX (CONT.)

489-18025 _____ 162	491-11027 _____ 46	518-90060 _____ 208	535-14170 _____ 117	538-12000 _____ 199
489-18050 _____ 162	491-11028 _____ 46	518-90160 _____ 209	535-14171 _____ 117	538-12200 _____ 199
489-18075 _____ 162	491-11029 _____ 46	531-60300 _____ 195	535-14172 _____ 117	538-12900 _____ 199
489-18100 _____ 162	491-11030 _____ 46	531-60570 _____ 195	535-14173 _____ 117	538-13000 _____ 199
489-18125 _____ 162	491-11031 _____ 46	531-75150 _____ 195	535-14174 _____ 117	538-13017 _____ 199
489-18150 _____ 162	491-11032 _____ 46	531-75190 _____ 195	535-14175 _____ 117	538-13023 _____ 199
489-18175 _____ 162	491-11033 _____ 46	531-75220 _____ 195	535-14177 _____ 117	538-14000 _____ 199
489-18200 _____ 162	491-11034 _____ 47	531-75310 _____ 195	535-14180 _____ 106	538-15100 _____ 199
489-18225 _____ 162	491-11035 _____ 46	531-95001 _____ 197	535-14181 _____ 116	538-15200 _____ 199
489-18250 _____ 162	491-11036 _____ 46	531-95002 _____ 197	535-14182 _____ 117	538-15400 _____ 199
489-18275 _____ 162	491-11038 _____ 46	532-07460 _____ 196	536-00001 _____ 197	538-30000 _____ 200
489-18300 _____ 162	491-11039 _____ 46	532-14381 _____ 196	536-00101 _____ 197	538-30200 _____ 200
491-00101 _____ 70	491-11133 _____ 54	532-74601 _____ 196	536-01121 _____ 197	538-30600 _____ 200
491-00133 _____ 54	491-19010 _____ 55	532-74602 _____ 196	536-01122 _____ 197	538-60100 _____ 200
491-01133 _____ 54	492-00502 _____ 51	533-00003 _____ 196	536-02040 _____ 197	538-60300 _____ 200
491-02006 _____ 55	492-02278 _____ 56	533-00010 _____ 196	536-02890 _____ 197	538-61100 _____ 200
491-02100 _____ 55	492-10134 _____ 56	533-00012 _____ 196	536-02910 _____ 197	538-61900 _____ 200
491-02101 _____ 55	492-10158 _____ 56	533-00045 _____ 196	536-06500 _____ 197	538-62600 _____ 200
491-02111 _____ 55	492-10180 _____ 56	533-01120 _____ 196	537-00001 _____ 198	538-70800 _____ 199
491-02301 _____ 54	492-10340 _____ 56	533-01140 _____ 196	537-00003 _____ 198	539-10001 _____ 200
491-02906 _____ 54	492-14916 _____ 56	533-01141 _____ 196	537-00004 _____ 198	541-90020 _____ 206
491-02919 _____ 54	492-15000 _____ 56	533-01180 _____ 196	537-00083 _____ 198	541-90030 _____ 206
491-02928 _____ 54	493-00801 _____ 147	533-01181 _____ 196	537-00353 _____ 198	541-90040 _____ 206
491-02939 _____ 54	493-91420 _____ 56	533-01182 _____ 196	537-05246 _____ 195	541-90101 _____ 206
491-11001 _____ 46	494-01010 _____ 147	533-01316 _____ 196	537-72967 _____ 195	550-90000 _____ 206
491-11002 _____ 46	494-08916 _____ 147	533-01381 _____ 196	537-90002 _____ 203	550-90002 _____ 206
491-11003 _____ 46	495-16004 _____ 45	533-01516 _____ 196	537-90003 _____ 203	550-90004 _____ 206
491-11004 _____ 46	495-16005 _____ 45	533-01716 _____ 196	537-90006 _____ 203	550-90005 _____ 206
491-11005 _____ 46	495-16006 _____ 45	533-01732 _____ 196	537-90009 _____ 203	550-90008 _____ 206
491-11006 _____ 46	495-16007 _____ 45	534-80001 _____ 197	537-90019 _____ 203	550-90009 _____ 206
491-11007 _____ 46	495-16008 _____ 45	534-80005 _____ 197	537-90035 _____ 203	550-90011 _____ 206
491-11008 _____ 46	495-16009 _____ 45	534-80011 _____ 197	537-90045 _____ 203	550-90012 _____ 206
491-11009 _____ 46	497-11800 _____ 110	534-80015 _____ 197	537-90116 _____ 203	550-90014 _____ 206
491-11010 _____ 46	497-11801 _____ 110	534-80036 _____ 197	537-90119 _____ 203	550-90015 _____ 206
491-11011 _____ 46	499-10180 _____ 56	534-80037 _____ 197	537-90135 _____ 203	550-90017 _____ 206
491-11012 _____ 46	499-10200 _____ 56	534-80057 _____ 197	537-90150 _____ 203	550-90018 _____ 206
491-11013 _____ 46	499-10340 _____ 56	534-80115 _____ 197	537-90155 _____ 203	550-90019 _____ 206
491-11014 _____ 46	499-10341 _____ 56	534-80136 _____ 197	537-90200 _____ 203	550-90031 _____ 206
491-11015 _____ 46	499-10660 _____ 56	534-80137 _____ 197	537-90201 _____ 203	550-90114 _____ 206
491-11016 _____ 46	501-90008 _____ 204	535-00150 _____ 106	537-92119 _____ 203	550-90200 _____ 206
491-11017 _____ 46	501-90018 _____ 204	535-14159 _____ 106	538-10200 _____ 199	550-90550 _____ 206
491-11018 _____ 46	501-90032 _____ 204	535-14160 _____ 116	538-10700 _____ 199	550-91000 _____ 206
491-11020 _____ 46	504-90005 _____ 204	535-14161 _____ 116	538-10900 _____ 199	550-92100 _____ 206
491-11021 _____ 46	504-90011 _____ 204	535-14162 _____ 116	538-11100 _____ 199	564-90012 _____ 207
491-11022 _____ 46	504-90016 _____ 204	535-14163 _____ 116	538-11200 _____ 199	564-90013 _____ 207
491-11023 _____ 46	504-90032 _____ 204	535-14164 _____ 116	538-11400 _____ 199	564-90014 _____ 207
491-11024 _____ 46	505-71216 _____ 196	535-14165 _____ 117	538-11600 _____ 199	564-90022 _____ 207
491-11025 _____ 46	505-90032 _____ 204	535-14168 _____ 106	538-11601 _____ 199	564-90111 _____ 207
491-11026 _____ 46	518-90030 _____ 209	535-14169 _____ 106	538-11800 _____ 199	571-90410 _____ 208

NUMERIC INDEX (CONT.)

571-90705 _____	208	736-10004 _____	198
571-91964 _____	209	751-00072 _____	184
571-91968 _____	209	844-16259 _____	105
576-90010 _____	208	844-16572 _____	105
576-90012 _____	208		
576-90014 _____	208		
576-90020 _____	208		
576-90040 _____	208		
576-90110 _____	208		
576-90111 _____	208		
576-90112 _____	208		
576-90114 _____	208		
576-90120 _____	208		
587-01150 _____	205		
587-01151 _____	205		
587-01152 _____	205		
587-01303 _____	205		
587-01306 _____	205		
587-01309 _____	205		
587-01406 _____	205		
587-01409 _____	205		
601-00101 _____	203		
603-00275 _____	212		
603-00825 _____	212		
603-43700 _____	212		
603-82502 _____	212		
603-82517 _____	212		
604-01275 _____	212		
605-00101 _____	211		
605-08028 _____	211		
605-14191 _____	211		
632-00005 _____	113		
632-00010 _____	113		
632-00032 _____	112		
632-00922 _____	112		
632-00923 _____	112		
632-01002 _____	113		
632-02400 _____	112		
632-10001 _____	113		
703-00509 _____	183		
703-00810 _____	183		
703-00812 _____	183		
703-00818 _____	183		
719-00018 _____	210		
719-00032 _____	210		
719-12001 _____	210		
719-12011 _____	210		
719-82222 _____	105		
721-63001 _____	211		

Ascot Supply Corporation is not responsible for inadvertent typographical errors or omissions. Images included in this publication may appear different to the actual inventoried item.



PROUD PARTNERS FOR OVER 50 YEARS!

Ken-Tool®
WHEREVER TIRES ARE CHANGED™

ASCOT™
Supply Corporation

**VALVECAPPER®
PRO**
CAP AND CORE REMOVER/INSTALLER



**TIRE
INFLATION
CAGES**

KEN-TOOL OFFERS
SIZES AND DESIGNS
FOR ALL YOUR NEEDS.



TG11E
FIBERGLASS
HANDLED
WEDGE

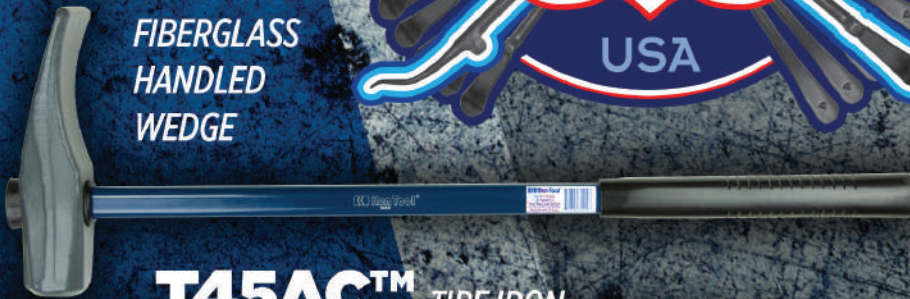

**TIRE
INFLATORS**
PROGRAMMABLE HANDHELD
AUTOMATIC TIRE INFLATOR



T45AC™ TIRE IRON



T45AS TIRE IRON

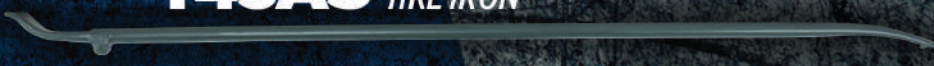

T45A TIRE IRON

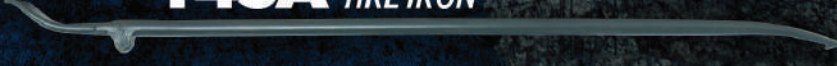

AUTEL MAXIBAS

BT608

GET CURRENT

BEST VALUE IN BATTERY & ELECTRICAL SYSTEM TESTERS

PROFESSIONAL & AFFORDABLE

- 50+ Vehicle Make Database
- AutoSCAN All Vehicle Systems Quickly Read & Erase Codes
- Perform Battery Registration & System Resets with Ease
- Accurate Battery Test Results - Approved by BCI & SAE
- Print, Save as a PDF or Email Results



ADAPTIVE LOAD & CONDUCTANCE



BMS RESET FUNCTIONALITY



SYSTEM DETECTION

BATTERY & ELECTRICAL SYSTEM DIAGNOSTICS

FASTER VEHICLE ID: AUTOVIN & VINSKAN

POWERED BY
AUTEL
DIAGNOSTICS



- BTAK**
- Measures Volts, Amps & Ohms
 - Works with Multimeter Functions in BT608
 - Troubleshoot Starters, Alternators & Key-Off Draw
- *BTAK Sold Separately*



AUTEL ACADEMY TECHNICAL TRAINING

AUTEL

Keep Vehicles Clean & Keep Customers Coming Back!

With over 30 years of refining the perfect products, the Slip-N-Grip® delivers unmatched quality and performance, providing the ultimate coverage for high traffic interior locations.

SEAT COVERS

FG-P9943-15

- 32" x 52"
- 0.5 mil
- 500/roll
- Advanced Slip-N-Grip® technology
- Disposable and recyclable



STEERING WHEEL COVERS

FB-P9943-33

- Elastic design is easy to apply
- Double-band style
- Stretches to 24"

PLASTIC FLOORMATS

FG-P9943-02

- 16.5" x 21" size perforated on a roll
- 2.0 mil for greater durability
- Waterproof
- One color custom imprinting available
- Recyclable



FLOOR DISPENSER RACK

FB-P9833-89

- 24" x 40" x 38"
- Locking casters keep rack in place
- Lower tray provides extra storage



PRIME HEAVY DUTY TREATED FLOORMATS

M3274PE1980A

- Blue Footprint design
- Durable coating for heavy foot traffic
- Vibrant, full color prints
- Bright white treated paper



REPAIR ORDER HOLDERS

FB-P9933-02

- Clear
- 10.5" x 14.5"
- 25/Box



TIRE STORAGE BAGS

FG-P9943-29	Standard	0.8 mil	250/roll
FG-P9933-92	Large	0.8 mil	250/roll
FG-P9933-91	X-Large	1.25 mil	125/roll

- White film hides the dirty tire
- Perforated rolls for easy storage and dispensing
- 3-layer construction for superior strength and durability
- Ideal for transport or storing of off-season tires



Customize with your brand for a professional look & to promote repeat business!

PLASTIC KEY TAGS

FB-P9933-23

- White
- 4 1/2" L x 3/4" W
- Self-locking arrows - no ring is needed
- 10 mil plastic vinyl
- Writeable surface
- 100ct packs - 1,000/box



TIRE LABELS

FB-P9943-79

- Standard and custom designs available
- 3" x 6"
- 500/roll



PAPER KEY TAGS

FB-P9833-13

- 1 3/8" W x 2 3/4" H
- Easy to write on
- Metal rings included
- 1,000/box

Gaither®

PROFESSIONAL EQUIPMENT

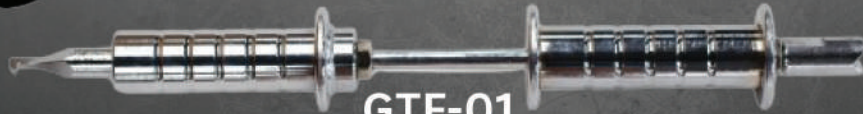

GTF-01

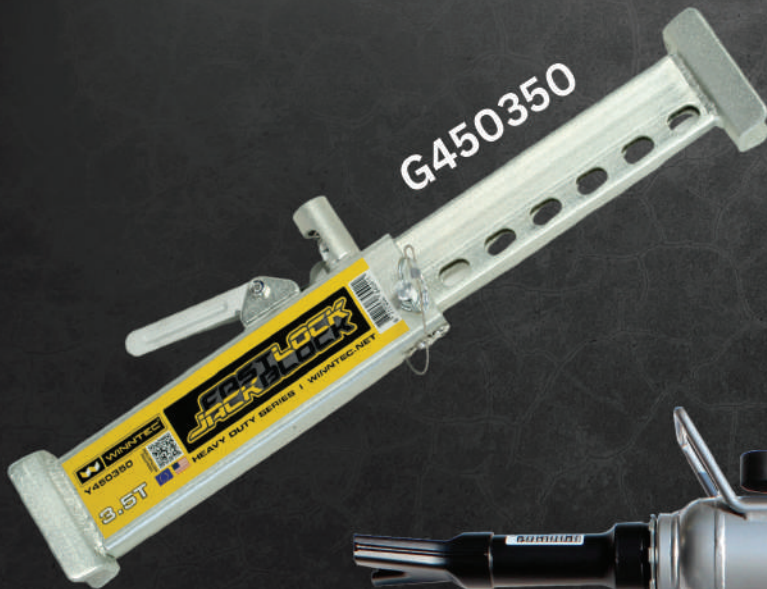

G450350



GTRP-01

GTJ-01



GBBL3L2



GBBL6L2



GBBL10L2

TIRE SUPPLY CATALOG

